

Vivado Design Suite Properties Reference Guide

UG912 (v2019.1) July 14, 2019



Revision History

The following table shows the revision history for this document.

Section	Revision Summary
07/14/2019 Version 2019.1	
ASYNC_REG	Noted support for SystemVerilog <code>logic</code> syntax.
KEEP_HIERARCHY	Removed comment about RTL only use.
PROHIBIT	Added note regarding the use of PROHIBIT on RAMB sites.
USER_CROSSING_SLR	Corrected priority when used with USER_SLR_ASSIGNMENT.
USER_SLR_ASSIGNMENT	Limited the applicable objects to hierarchical cells.

Table of Contents

Revision History	2
Chapter 1: Vivado Design Suite First Class Objects	
Introduction	8
Copying Examples from this Document	9
Netlist and Device Objects	10
Block Design Objects	13
Hardware Manager Objects	15
Chapter 2: Alphabetical List of First Class Objects	
BD_ADDR_SEG	17
BD_ADDR_SPACE	20
BD_CELL	22
BD_INTF_NET	24
BD_INTF_PIN	26
BD_INTF_PORT	29
BD_NET	31
BD_PIN	33
BD_PORT	35
BEL	37
BEL_PIN	41
CELL	43
CLOCK	47
CLOCK_REGION	50
DIAGRAM	52
HW_AXI	53
HW_BITSTREAM	55
HW_CFGMEM	57
HW_DEVICE	59
HW_ILA	62
HW_ILA_DATA	65
HW_PROBE	66
HW_SERVER	68

HW_SIO_GT	69
HW_SIO_GTGROUP	79
HW_SIO_IBERT	80
HW_SIO_PLL	82
HW_SIO_RX	84
HW_SIO_TX	90
HW_SYSMON	94
HW_TARGET	98
HW_VIO	100
IO_BANK	102
IO_STANDARD	104
NET	106
NODE	110
PACKAGE_PIN	112
PIN	114
PIP or SITE_PIP	117
PKGPIN_BYTEGROUP	120
PKGPIN_NIBBLE	122
PORT	124
SITE	127
SLR	131
TILE	133
TIMING_PATH	137
WIRE	140

Chapter 3: Key Property Descriptions

Properties Information	142
ASYNC_REG	143
AUTO_INCREMENTAL_CHECKPOINT	147
BEL	149
BLACK_BOX	152
BLOCK_SYNTH	154
BUFFER_TYPE	156
CARRY_REMAP	157
CASCADE_HEIGHT	159
CELL_BLOAT_FACTOR	160
CFGBVS	162
CLOCK_BUFFER_TYPE	164
CLOCK_DEDICATED_ROUTE	166
CLOCK_DELAY_GROUP	169

CLOCK_LOW_FANOUT.....	171
CLOCK_REGION	173
CLOCK_ROOT	175
CONFIG_MODE.....	177
CONFIG_VOLTAGE	179
CONTAIN_ROUTING.....	181
CONTROL_SET_REMAP	183
DCI_CASCADE.....	185
DELAY_BYPASS.....	187
DIFF_TERM	188
DIFF_TERM_ADV	191
DIRECT_ENABLE	193
DIRECT_RESET	195
DONT_TOUCH.....	197
DQS_BIAS	201
DRIVE	204
EDIF_EXTRA_SEARCH_PATHS	206
EQUALIZATION	207
EQUIVALENT_DRIVER_OPT	209
EXCLUDE_PLACEMENT.....	211
FSM_ENCODING.....	213
FSM_SAFE_STATE.....	215
GATED_CLOCK	217
GENERATE_SYNTH_CHECKPOINT	219
H_SET and HU_SET.....	221
HIODELAY_GROUP.....	225
HLUTNM	228
IBUF_LOW_PWR	232
IN_TERM.....	234
INCREMENTAL_CHECKPOINT	237
INTERNAL_VREF	239
IO_BUFFER_TYPE	241
IOB.....	243
IOB_TRI_REG	245
IOBDELAY	246
IODELAY_GROUP	248
IOSTANDARD	251
IP_REPO_PATHS.....	254
IS_ENABLED	256
KEEP	258

KEEP_COMPATIBLE	261
KEEP_HIERARCHY.....	263
KEEPER	266
LOC	268
LOCK_PINS	271
LOCK_UPGRADE.....	275
LUTNM	277
LUT_REMAP	281
LVDS_PRE_EMPHASIS	283
MARK_DEBUG	285
MAX_FANOUT	288
MUXF_REMAP	290
ODT	292
OFFSET_CNTRL	294
PACKAGE_PIN.....	296
PATH_MODE.....	298
PBLOCK.....	300
POST_CRC.....	302
POST_CRC_ACTION	304
POST_CRC_FREQ	306
POST_CRC_INIT_FLAG	308
POST_CRC_SOURCE	310
PRE_EMPHASIS.....	312
PROCESSING_ORDER.....	314
PROHIBIT	316
PULLDOWN.....	317
PULLTYPE	319
PULLUP	322
RAM_DECOMP	324
RAM_STYLE.....	326
REF_NAME	328
REF_PIN_NAME	329
RLOC	330
RLOCS	334
RLOC_ORIGIN	336
ROUTE_STATUS	339
RPM.....	341
RPM_GRID	342
SEVERITY.....	344
SLEW	346

SYNTH_CHECKPOINT_MODE	349
U_SET	352
UNAVAILABLE_DURING_CALIBRATION	356
USE_DSP	358
USED_IN	360
USER_CLOCK_ROOT	362
USER_CROSSING_SLR	364
USER_SLL_REG	366
USER_SLR_ASSIGNMENT	368
VCCAUX_IO	370

Appendix A: Additional Resources

Xilinx Resources	372
Solution Centers	372
Documentation Navigator and Design Hubs	372
References	373
Training Resources	374
Please Read: Important Legal Notices	374

Vivado Design Suite First Class Objects

Introduction

This reference manual discusses the first class objects, and the properties available for those objects, in the Xilinx® Vivado® Design Suite. It consists of the following:

- **Chapter 1, Vivado Design Suite First Class Objects:** Describes the various design and device objects used by the Vivado Design Suite to model the FPGA design database. Presents the objects sorted according to specific categories, with links to detailed object descriptions in the next chapter.
- **Chapter 2, Alphabetical List of First Class Objects:** List the Vivado Design Suite first class objects in alphabetical order. A definition of the object, a list of related objects, and a list of properties attached to each object are provided.
- **Chapter 3, Key Property Descriptions:** For many Vivado Design Suite properties, a description, supported architectures, applicable elements, values, syntax examples (Verilog, VHDL, and XDC), and affected steps in the design flow are provided.
- **Appendix A, Additional Resources:** Resources and documents available on the Xilinx support website at www.xilinx.com/support are provided.

Copying Examples from this Document



CAUTION! *Please read this section carefully before copying syntax or coding examples from this document into your code.*

This guide gives numerous syntax and coding examples to assist you in inserting properties into your code. Problems may arise if you copy those examples directly from this PDF document into your code.

- The dash character, '-', may be replaced with an en-dash or em-dash character when copying and pasting from the PDF into the Vivado tools Tcl console, or into a Tcl script or XDC file.
- PDF documents insert end of line markers into examples that wrap from line to line. These markers will cause errors in your Tcl scripts or XDC files.
- Copying examples that span more than one page in the PDF captures extraneous header and footer information along with the example. This extraneous information causes errors in your Tcl scripts or XDC files.

To avoid these problems, edit the example in an ASCII text editor to remove any unnecessary markers or information, then paste it into your code, or the Vivado Design Suite Tcl shell or Tcl console.

Netlist and Device Objects

Vivado Design Suite supports a number of first class objects in the in-memory design database. These objects represent the cells, nets, and ports of the logical design, the device resources of the target Xilinx device, or platform board, as well as objects used by specific features of the Vivado Design Suite such as block design objects used by IP integrator, or hardware objects used by the Vivado hardware manager. The Vivado Design Suite maps the netlist objects of the logical design onto the device objects of the target device or board. [Figure 1-1, page 10](#) illustrates the relationships between some of the Vivado tools first class objects. This figure is representative, and is not intended to depict all Vivado tools first class objects, or their relationships.

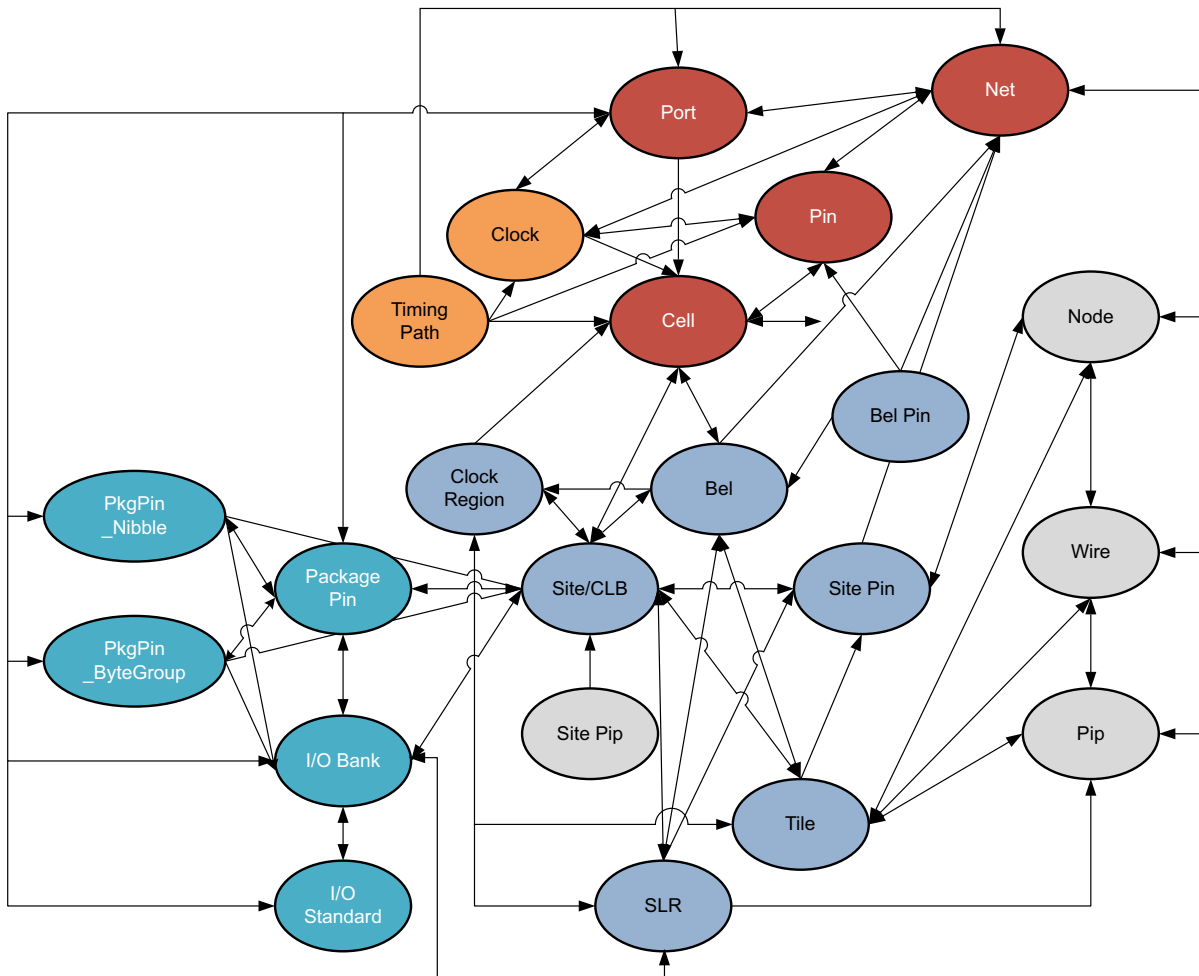

X14826-071619

Figure 1-1: Netlist and Device Objects

The netlist objects, displayed at the top of [Figure 1-1](#), are part of the logical design for programming into the FPGA. Device objects, shown in the lower half of the figure, are part of the actual physical device, and include area resources such as clock regions, tiles, sites or

CLBs. Device objects also include package pins and I/O banks, shown on the left side of the figure, and routing resources such as nodes, wires, and pips, shown on the right in the figure.

Additional categories of first class objects exist in the Vivado Design Suite, such as timing objects, which combine with the netlist design to create timing reports and constrain placement and routing results. Timing objects associated with the netlist and device objects, provide a complete timing analysis of the implemented design. Timing objects include clocks, timing paths, and delay objects.

The relationship between objects is shown by the arrows connecting two objects:

- A double headed arrow indicates that the relationship can be queried from either direction. For instance, you can query the cells attached to specific nets (`get_cells -of_objects [get_nets]`), or query the nets connected to specific cells (`get_nets -of_objects [get_cells]`).
- A single-ended arrow reflects a relationship that can only be queried in the direction of the arrow. For instance, in [Figure 1-1](#), you can see that you can query the bels located in specific clock regions (`get_bels -of_objects [get_clock_regions]`), but you cannot get clock regions associated with specific bels.

A description of first class objects, their relationships to other objects, and the properties defined on those objects follows.

Netlist Objects

- [CELL](#), page 43
- [CLOCK](#), page 47
- [NET](#), page 106
- [PIN](#), page 114
- [PORT](#), page 124
- [TIMING_PATH](#), page 137

Device Resource Objects

- [BEL](#), page 37
- [BEL_PIN](#), page 41
- [CLOCK_REGION](#), page 50
- [IO_BANK](#), page 102
- [IO_STANDARD](#), page 104
- [NODE](#), page 110

- [PACKAGE_PIN](#), page 112
- [PIP or SITE_PIP](#), page 117
- [PKGPIN_BYTEGROUP](#), page 120
- [PKGPIN_NIBBLE](#), page 122
- [SITE](#), page 127
- [SLR](#), page 131
- [TILE](#), page 133
- [WIRE](#), page 140

Block Design Objects

Block Designs are complex subsystem designs made up of interconnected IP cores, that can either serve as stand-alone designs, or be integrated into other designs. Block Designs, or diagrams, can be created with the IP integrator of the Vivado Design Suite. They can be created interactively, on the canvas of the IP Integrator in the Vivado Design Suite IDE, or interactively using Tcl commands.

The Block Design diagram objects are structurally very similar to the netlist objects previously described. The relationships between the different design objects that make up Block Designs, or diagrams, are illustrated in [Figure 1-2](#).

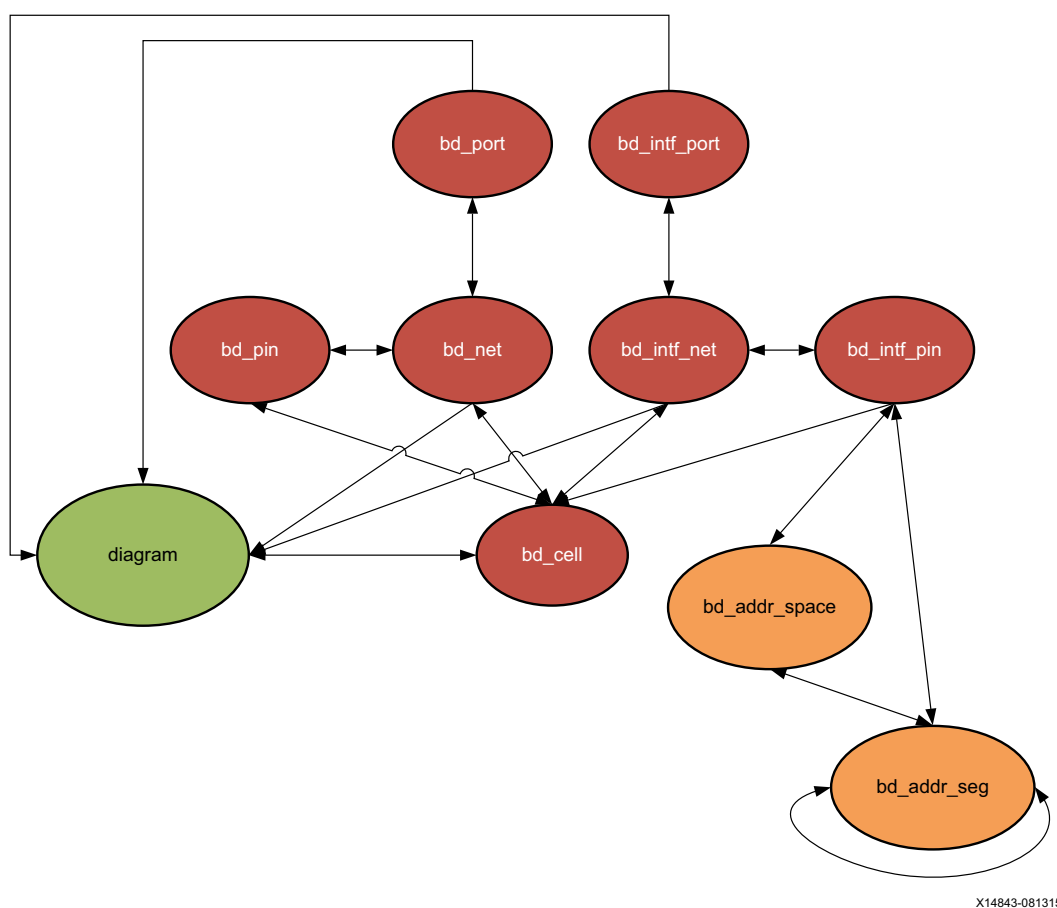

Figure 1-2: Block Design Objects

As seen in the figure above, the block diagram objects include:

- [DIAGRAM](#), page 52
- [BD_ADDR_SPACE](#), page 20
- [BD_ADDR_SEG](#), page 17

- [BD_CELL](#), page 22
- [BD_INTF_NET](#), page 24
- [BD_INTF_PIN](#), page 26
- [BD_INTF_PORT](#), page 29
- [BD_NET](#), page 31
- [BD_PIN](#), page 33
- [BD_PORT](#), page 35

Hardware Manager Objects

The Hardware Manager is a feature of the Vivado Design Suite that lets you connect to a device programmer or debug board, and exercise the programmed hardware device. The Hardware Manager lets you exercise debug logic on devices, accessing signals to set or retrieve current values. The many debug cores and objects of the Vivado hardware manager are shown in Figure 1-3.

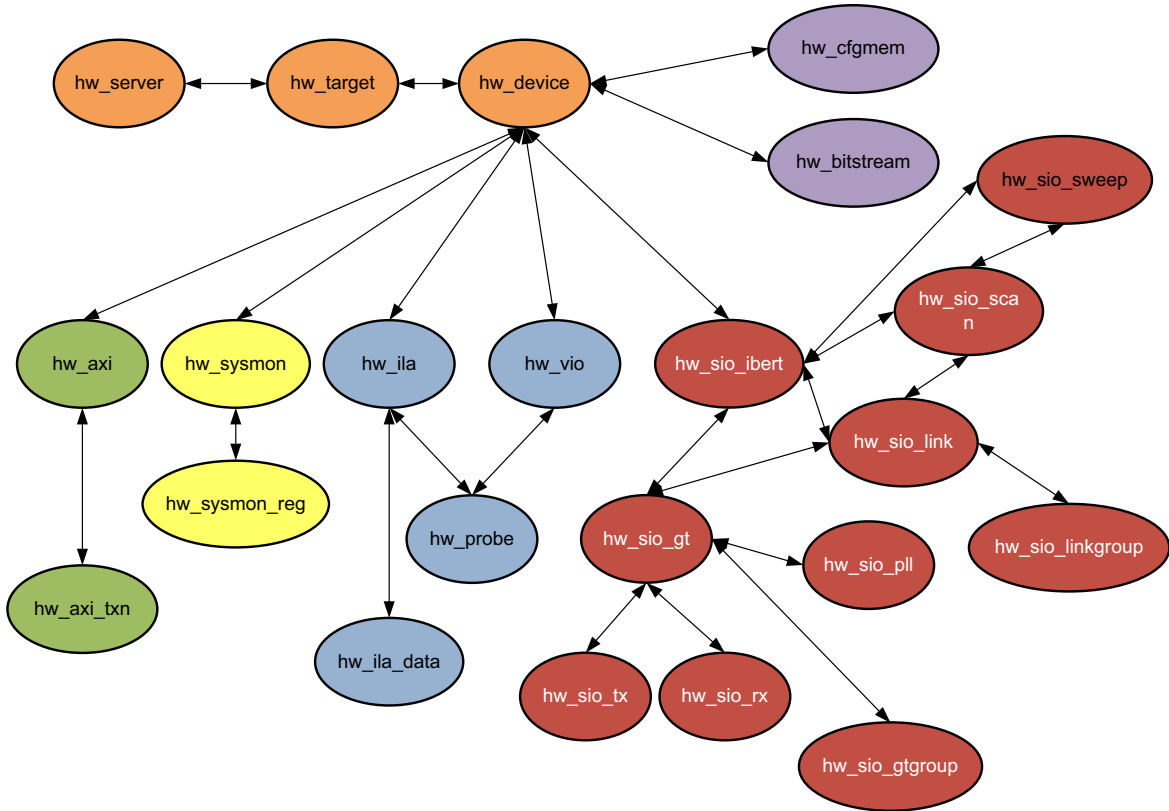

X14844-081315

Figure 1-3: Hardware Manager Objects

Debug cores can be instantiated into an RTL design from the Xilinx IP catalog, or in the case of the ILA or VIO debug cores, can be inserted into the synthesized netlist using the netlist-based debug flow. Refer to *Vivado Design Suite User Guide: Programming and Debugging* (UG908) [Ref 23] for more information.

As seen in the figure above, the Vivado hardware manager objects include:

- [HW_AXI](#), page 53
- [HW_BITSTREAM](#), page 55
- [HW_CFGMEM](#), page 57

- [HW_DEVICE](#), page 59
- [HW_ILA](#), page 62
- [HW_ILA_DATA](#), page 65
- [HW_PROBE](#), page 66
- [HW_SERVER](#), page 68
- [HW_SIO_GT](#), page 69
- [HW_SIO_GTGROUP](#), page 79
- [HW_SIO_IBERT](#), page 80
- [HW_SIO_PLL](#), page 82
- [HW_SIO_RX](#), page 84
- [HW_SIO_TX](#), page 90
- [HW_SYSMON](#), page 94
- [HW_TARGET](#), page 98
- [HW_VIO](#), page 100

Alphabetical List of First Class Objects

BD_ADDR_SEG

Description

Address segments, or `bd_addr_seg` objects, describe the location and size of a range of memory. They have a range (size) and an optional starting offset.

For various memory mapped master and slave interfaces, IP integrator follows the industry standard IP-XACT data format for capturing memory requirements and capabilities of endpoint masters and slaves.

Addressable slave interfaces reference an address segment container, called a memory map. These memory maps are usually named after the slave interface pins, for example `S_AXI`, though that is not required.

The memory map contains slave address segments. These address segments correspond to the address decode window for the slave interface referencing the memory map. When specified in the memory map, slave segments must have a range and can optionally have a hard offset, (indicating that the slave can only be mapped into master address spaces at that offset or apertures of it).

A typical AXI4-Lite slave interface for instance references a memory map with only one address segment, representing a range of memory. However, some slaves, like a bridge, will have multiple address segments; or a range of addresses for each address decode window.

Slave address segments are assigned into master address spaces using the `assign_bd_address` or `create_bd_addr_seg` command.

Addressing master interfaces reference an address segment container called an Address Space, or `bd_addr_space`. The address space is referenced by interface pins, `bd_intf_pin`, on the cell. In the case of external AXI masters, the address space is referenced by the external interface port, `bd_intf_port`. Several interfaces of varying protocols may reference the same master address space. The Microblaze processor Data address space, for instance, is referenced by its DLMB, `M_AXI_DP` and `M_AXI_DC` interfaces.

The Address space contains master address segments. These master address segments reference slave address segments that have been assigned into the master address space, and the offset and range at which the master accesses it.

Related Objects

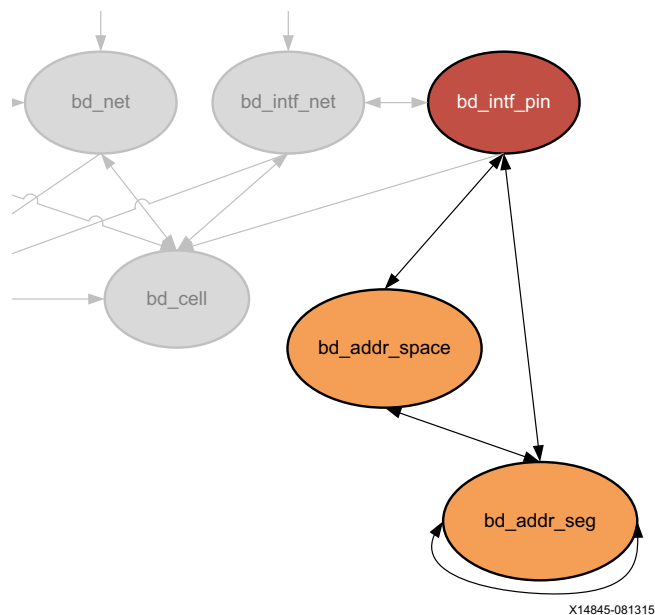

Figure 2-1: Block Design Address Space and Address Segments

The `bd_addr_seg` object refers to both master and slave address segments. The `bd_addr_space` object refers to both memory maps and master address spaces.

You can query the relationship between all related address spaces and address segments. For example:

```
# Get the slave address segments of a memory map space.
get_bd_addr_segs -of_objects [get_bd_addr_spaces /mdm_1/S_AXI]

# Get the master address segments of amaster address space.
get_bd_addr_segs -of_objects [get_bd_addr_spaces /Microblaze_0/Data]

# Get the slave address segment from its referenced master address segment, or the
# master address segment from its referencing slave address segment.
get_bd_addr_segs -of_objects [get_bd_addr_segs <slave or master>_segment]

# Get the addr_segs referencing/referenced by interfaces.
# Get all Master or slave interfaces.
set vMB [get_bd_intf_pins -of_objects [get_bd_cells *] -filter {Mode == "Master"}]
set vSB [get_bd_intf_pins -of_objects [get_bd_cells *] -filter {Mode == "Slave"}]

# Get master segments
set vMS [get_bd_addr_segs -of_objects $vMB]

# Get slave segments
set vSS [get_bd_addr_segs -of_objects $vSB]
```

Properties

The properties on a block design address segment object, `bd_addr_seg`, include the following, with example values:

Property	Type	Read-only	Visible	Value
ACCESS	string	false	true	read-write
CLASS	string	true	true	bd_addr_seg
EXEIMG	string	false	true	
MEMTYPE	string	false	true	data
NAME	string	false	true	SEG_axi_gpio_0_Reg
OFFSET	string	false	true	0x40000000
PATH	string	true	true	/microblaze_0/Data/SEG_axi_gpio_0_Reg
RANGE	string	false	true	0x00010000
SECURE	bool	false	true	0
USAGE	string	false	true	register

To report the properties for a `bd_addr_seg` object, you can copy and paste the following command into the Vivado Design Suite Tcl shell or Tcl console:

```
report_property -all [lindex [get_bd_addr_segs ] 0]
```

BD_ADDR_SPACE

Description

An address space, or `bd_addr_space` object, is an assigned logically addressable space of memory on a master interface, or on AXI interface ports connected to an AXI master external to the block design.

The IP integrator of the Vivado Design Suite follows the industry standard IP-XACT data format for capturing memory requirements and capabilities. Some blocks may have one address space associated with multiple master interfaces, for example a processor with a system bus and fast memory bus. Other components may have multiple address spaces associated with multiple master interfaces, one for instruction and the other for data.

Master interfaces reference address spaces, or `bd_addr_space` objects. When an AXI slave is mapped to a master address space, a master address segment (`bd_addr_seg`) object is created, mapping the address segments of the slave to the master.

Related Objects

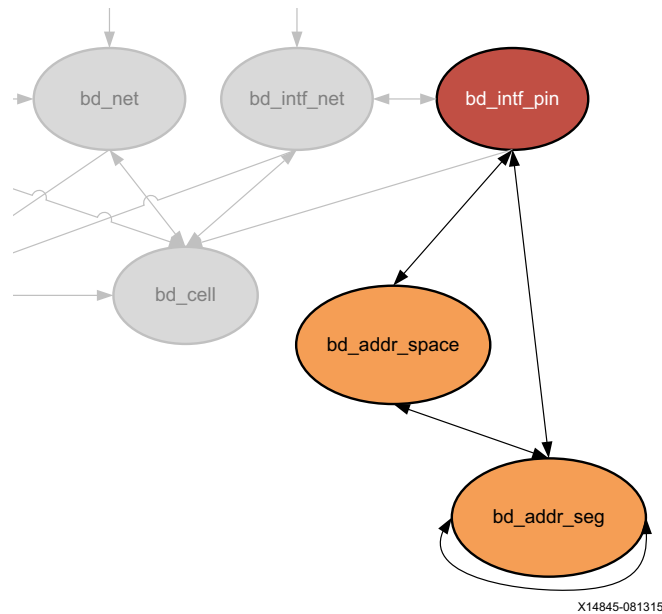

Figure 2-2: Block Design Address Space and Address Segments

The master address segment, `bd_addr_seg`, is associated with the address spaces in AXI master interfaces, found on a block design. The address space is referenced by the interface pins, `bd_intf_pin`, on the cell, `bd_cell`. External AXI masters are associated with interface ports, `bd_intf_port`.

You can query the `bd_addr_space` objects of these associated objects:

```
get_bd_addr_spaces -of_objects [get_bd_cells /microblaze_0]
get_bd_addr_segs -of_objects [get_bd_addr_spaces -of_objects [get_bd_cells
/microblaze_0]]
```

You can also query the objects associated with the block design address spaces:

```
get_bd_intf_pins -of_objects [get_bd_addr_spaces *SLMB]
```

Properties

The properties on a block design address space object, `bd_addr_space`, include the following, with example values:

Property	Type	Read-only	Visible	Value
CLASS	string	true	true	bd_addr_space
NAME	string	false	true	Data
OFFSET	string	false	true	0x00000000
PATH	string	true	true	/microblaze_0/Data
RANGE	string	false	true	0x100000000
TYPE	string	false	true	

To report the properties for a `bd_addr_space` object, you can copy and paste the following command into the Vivado Design Suite Tcl shell or Tcl console:

```
report_property -all [lindex [get_bd_addr_spaces ] 0]
```

BD_CELL

Description

A block design cell, or `bd_cell` object, is an instance of an IP integrator IP core object, or is a hierarchical block design cell. A leaf-cell is a core from the IP catalog. A hierarchical cell is a module or block that contains one or more additional levels of logic, including leaf-cells.

The `TYPE` property of the `bd_cell` object identifies the block design cell as either a leaf-cell coming from the IP catalog (`TYPE == IP`), or as a hierarchical module containing additional logic (`TYPE == HIER`).

Related Objects

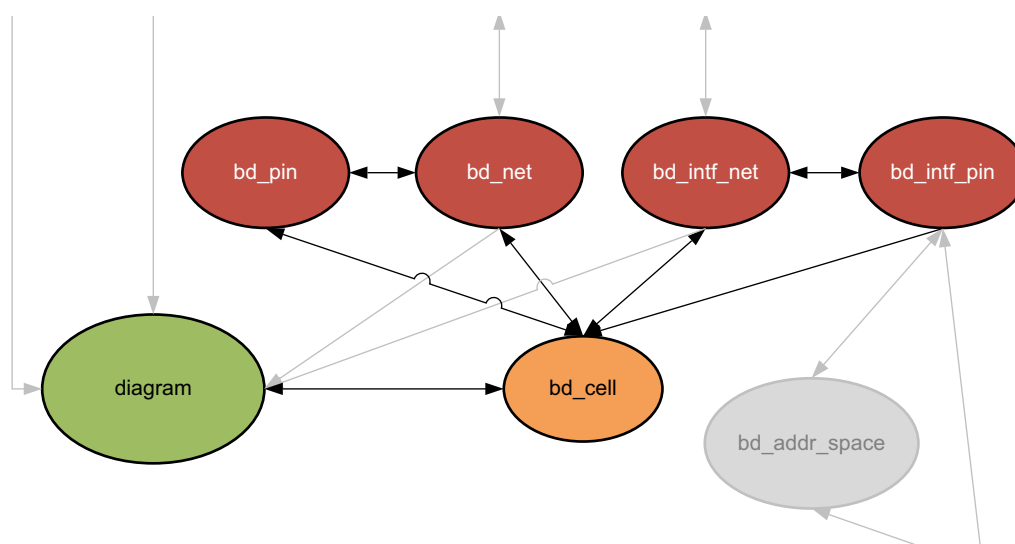

Figure 2-3: Block Design Cells

As seen in [Figure 2-3](#), Block design cells (`bd_cell`) are found in a block design, or diagram object. The cells include block design pins (`bd_pin`) and interface pins (`bd_intf_pin`), and can hierarchically contain block design ports (`bd_port`) and interface ports (`bd_intf_port`). They are connected by nets (`bd_net`) and interface nets (`bd_intf_net`). Memory related block design cells can also contain address spaces (`bd_addr_space`), and address segments (`bd_addr_seg`). You can query the block design cells that are associated with any of these objects, for example:

```
get_bd_cells -of_objects [get_bd_addr_spaces]
```

You can query the objects associated with block design cells:

```
get_bd_addr_spaces -of_objects [get_bd_cells]
```

You can also query the block design cells that are hierarchically objects of another block design cell:

```
get_bd_cells -of_objects [get_bd_cells microblaze_0_axi_periph]
```

Properties

The specific properties on a block design cell object can be numerous and varied, depending on the type of IP core the object represents. The following table lists some of the properties assigned to a `bd_cell` object in the Vivado Design Suite, with example values:

Property	Type	Read-only	Visible	Value
CLASS	string	true	true	bd_cell
CONFIG.C_ALL_INPUTS	string	false	true	0
CONFIG.C_ALL_INPUTS_2	string	false	true	0
CONFIG.C_ALL_OUTPUTS	string	false	true	1
CONFIG.C_ALL_OUTPUTS_2	string	false	true	0
CONFIG.C_DOUT_DEFAULT	string	false	true	0x00000000
CONFIG.C_DOUT_DEFAULT_2	string	false	true	0x00000000
CONFIG.C_GPIO2_WIDTH	string	false	true	32
CONFIG.C_GPIO_WIDTH	string	false	true	4
CONFIG.C_INTERRUPT_PRESENT	string	false	true	0
CONFIG.C_IS_DUAL	string	false	true	0
CONFIG.C_TRI_DEFAULT	string	false	true	0xFFFFFFFF
CONFIG.C_TRI_DEFAULT_2	string	false	true	0xFFFFFFFF
CONFIG.Component_Name	string	false	true	base_mb_axi_gpio_0_0
CONFIG.GPIO2_BOARD_INTERFACE	string	false	true	Custom
CONFIG.GPIO_BOARD_INTERFACE	string	false	true	led_4bits
CONFIG.USE_BOARD_FLOW	string	false	true	true
LOCATION	string	false	true	5 1720 200
LOCK_UPGRADE	bool	false	true	0
NAME	string	false	true	axi_gpio_0
PATH	string	true	true	/axi_gpio_0
SCREENSIZE	string	false	true	180 116
SDX_KERNEL	string	true	false	false
SDX_KERNEL_SIM_INST	string	true	false	
SDX_KERNEL_SYNTH_INST	string	true	false	
SDX_KERNEL_TYPE	string	true	false	
SELECTED_SIM_MODEL	string	false	true	rtl
TYPE	string	true	true	ip
VLNV	string	true	true	xilinx.com:ip:axi_gpio:2.0

To report the properties for a `bd_cell` object, you can copy and paste the following command into the Vivado Design Suite Tcl shell or Tcl console:

```
report_property -all [lindex [get_bd_cells] 0]
```

BD_INTF_NET

Description

An interface is a grouping of signals that share a common function, containing both individual signals and multiple buses. An AXI4-Lite master, for example, contains a large number of individual signals plus multiple buses, which are all required to make a connection. By grouping these signals and buses into an interface, the Vivado IP integrator can identify common interfaces and automatically make multiple connections in a single step.

An interface is defined using the IP-XACT standard. Standard interfaces provided by Xilinx can be found in the Vivado tools installation directory at `data/ip/interfaces`. See the *Vivado Design Suite User Guide: Designing IP Subsystems Using IP Integrator* (UG994) [Ref 27] for more information on interface nets, pins, and ports.

A block design interface net, or a `bd_intf_net` object, connects the interface pins on a block design cell to other interface pins, or to external interface ports. The `bd_intf_net` object connects through multiple levels of the design hierarchy, connecting block design cells. Every interface net has a name which identifies it in the design. All block design cells, interface pins, and interface ports connected to these nets are electrically connected.

Related Objects

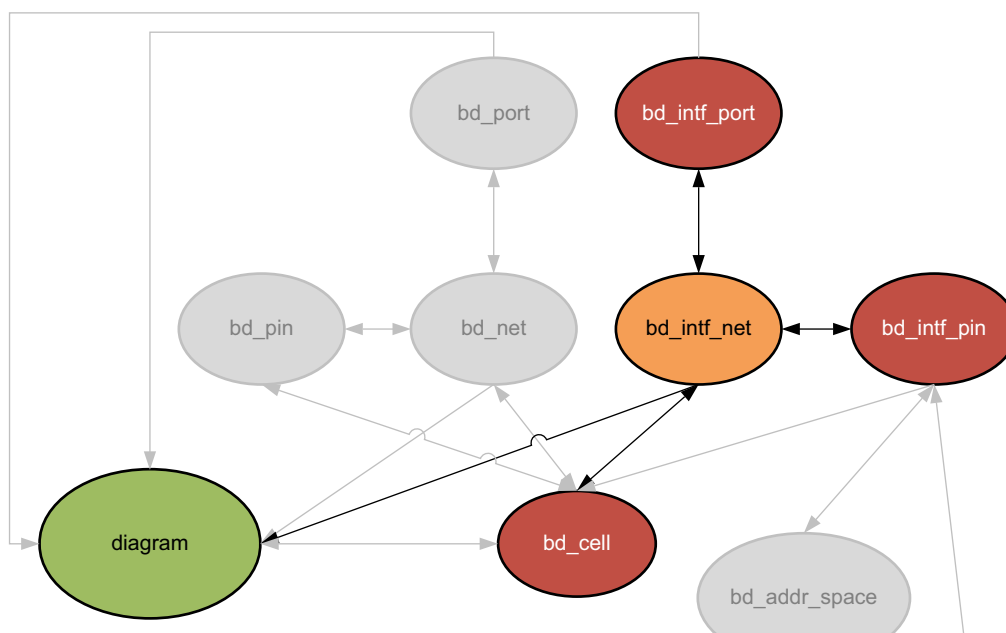

Figure 2-4: Block Design Interface Nets

As seen in [Figure 2-4, page 24](#), the block design interface net, `bd_intf_net` object, occurs in a block design, or diagram. It is connected to interface ports (`bd_intf_port`), and through interface pins (`bd_intf_pin`) to block design cells (`bd_cell`) in the diagram. You can query the `bd_intf_nets` of the diagram, `bd_cell`, `bd_intf_pin`, and `bd_intf_port` objects.

```
get_bd_intf_nets -of_objects [get_bd_ports]
```

In addition, you can query the block design cells (`bd_cell`) or the `bd_intf_pins` or `bd_intf_port` objects that are connected to a specific `bd_intf_net`:

```
get_bd_cells -of_objects [get_bd_intf_nets /INTERRUPT_1_1]
```

Properties

The properties on the `bd_intf_net` object include the following:

Property	Type	Read-only	Visible	Value
CLASS	string	true	true	<code>bd_intf_net</code>
NAME	string	false	true	<code>microblaze_0_axi_periph_to_s00_couplers</code>
PATH	string	true	true	<code>/microblaze_0_axi_periph/microblaze_0_axi_periph_to_s00_couplers</code>

To report the properties for the `bd_intf_net` object, you can copy and paste the following command into the Vivado Design Suite Tcl shell or Tcl console:

```
report_property -all [lindex [get_bd_intf_nets] 0]
```

BD_INTF_PIN

Description

An interface is a grouping of signals that share a common function, containing both individual signals and multiple buses. An AXI4-Lite master, for example, contains a large number of individual signals plus multiple buses, which are all required to make a connection. By grouping these signals and buses into an interface, the Vivado IP integrator can identify common interfaces and automatically make multiple connections in a single step.

An interface is defined using the IP-XACT standard. Standard interfaces provided by Xilinx can be found in the Vivado tools installation directory at `data/ip/interfaces`. See the *Vivado Design Suite User Guide: Designing IP Subsystems Using IP Integrator* (UG994) [Ref 27] for more information on interface nets, pins, and ports.

A block design interface pin, or a `bd_intf_pin` object, is a point of logical connectivity on a block design cell. An interface pin allows the internals of a cell to be abstracted away and simplified for ease-of-use. Interface pins can appear on hierarchical block design cells, or leaf-level cells.

Related Objects

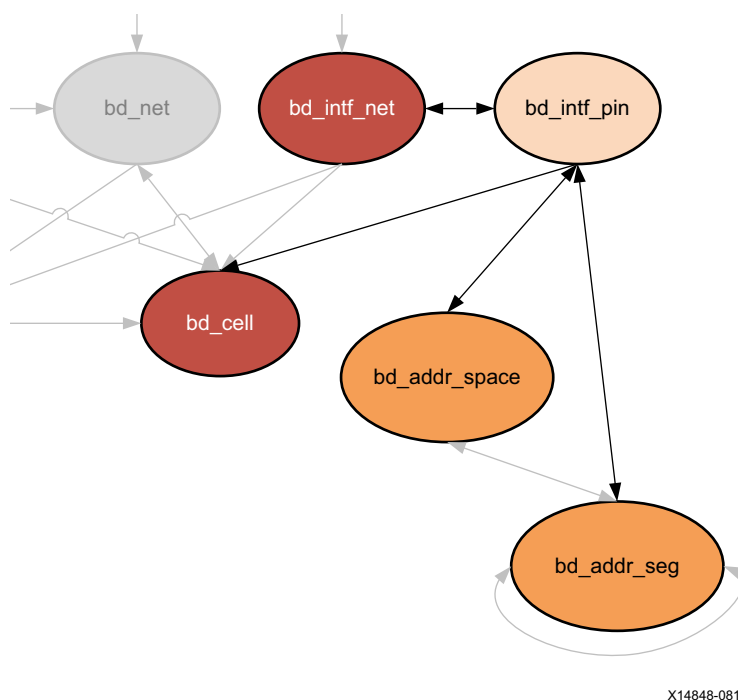

Figure 2-5: Block Design Interface Pin

A block design interface pin is attached to a block design cell (bd_cell), and can be connected to other interface pins (bd_intf_pin) or interface ports (bd_intf_port) by an interface net (bd_intf_net) in the block design, or diagram.

You can query the bd_intf_pins of bd_addr_space, bd_addr_seg, bd_cell, and bd_intf_net objects:

```
get_bd_intf_pins -of_objects [get_bd_cells clk_wiz_1]
```

You can also query the bd_addr_spaces, bd_addr_segs, bd_cells, and bd_intf_nets, of a specific bd_intf_pin:

```
get_bd_addr_spaces -of_objects [get_bd_intf_pins microblaze_0/*]
```

Properties

The specific properties on a block design interface pin object can vary depending on the type of the pin. The following table lists some of the properties assigned to a master AXI interface pin object, with example values:

Property	Type	Read-only	Visible	Value
BRIDGES	string	false	false	
CLASS	string	true	true	bd_intf_pin
CONFIG.ADDR_WIDTH	string	true	true	32
CONFIG.ARUSER_WIDTH	string	true	true	0
CONFIG.AWUSER_WIDTH	string	true	true	0
CONFIG.BUSER_WIDTH	string	true	true	0
CONFIG.CLK_DOMAIN	string	true	true	base_mb_clk_wiz_1_0_clk_out1
CONFIG.DATA_WIDTH	string	true	true	32
CONFIG.FREQ_HZ	string	true	true	100000000
CONFIG.HAS_BRESP	string	true	true	1
CONFIG.HAS_BURST	string	true	true	0
CONFIG.HAS_CACHE	string	true	true	0
CONFIG.HAS_LOCK	string	true	true	0
CONFIG.HAS_PROT	string	true	true	1
CONFIG.HAS_QOS	string	true	true	0
CONFIG.HAS_REGION	string	true	true	0
CONFIG.HAS_RRESP	string	true	true	1
CONFIG.HAS_WSTRB	string	true	true	1
CONFIG.ID_WIDTH	string	true	true	0
CONFIG.MAX_BURST_LENGTH	string	true	true	1
CONFIG.NUM_READ_OUTSTANDING	string	true	true	1
CONFIG.NUM_READ_THREADS	string	true	true	1
CONFIG.NUM_WRITE_OUTSTANDING	string	true	true	1
CONFIG.NUM_WRITE_THREADS	string	true	true	1
CONFIG.PHASE	string	true	true	0.0
CONFIG.PROTOCOL	string	true	true	AXI4LITE
CONFIG.READ_WRITE_MODE	string	true	true	READ_WRITE
CONFIG.RUSER_BITS_PER_BYTE	string	true	true	0
CONFIG.RUSER_WIDTH	string	true	true	0
CONFIG.SUPPORTS_NARROW_BURST	string	true	true	0
CONFIG.WUSER_BITS_PER_BYTE	string	true	true	0
CONFIG.WUSER_WIDTH	string	true	true	0
LOCATION	string	false	true	
MODE	string	true	true	Master

```

NAME                string  false   true    M_AXI_DP
PATH                string  true    true    /microblaze_0/M_AXI_DP
TYPE                string  true    true    ip
VLNV                string  true    true
xilinx.com:interface:aximm_rtl:1.0
    
```

To report the properties for the `bd_intf_pin` object, you can copy and paste the following command into the Vivado Design Suite Tcl shell or Tcl console:

```
report_property -all [lindex [get_bd_intf_pins */*] 0]
```

Or use the following Tcl script to report the properties of each `bd_intf_pin` object on each block design cell:

```

foreach x [get_bd_intf_pins -of_objects [get_bd_cells]] {
  puts "Next Interface Pin starts here
  .....
  report_property -all $x
}
    
```

BD_INTF_PORT

Description

An interface is a grouping of signals that share a common function, containing both individual signals and multiple buses. An AXI4-Lite master, for example, contains a large number of individual signals plus multiple buses, which are all required to make a connection. By grouping these signals and buses into an interface, the Vivado IP integrator can identify common interfaces and automatically make multiple connections in a single step.

An interface is defined using the IP-XACT standard. Standard interfaces provided by Xilinx can be found in the Vivado tools installation directory at `data/ip/interfaces`. See the *Vivado Design Suite User Guide: Designing IP Subsystems Using IP Integrator* (UG994) [Ref 27] for more information on interface nets, pins, and ports.

A block design interface port is a special type of hierarchical pin, a pin on the top-level of the block diagram. In block designs, ports and interface are primary ports communicating the external connection of the block design or diagram from or to the overall FPGA design, or system level design.

Related Objects

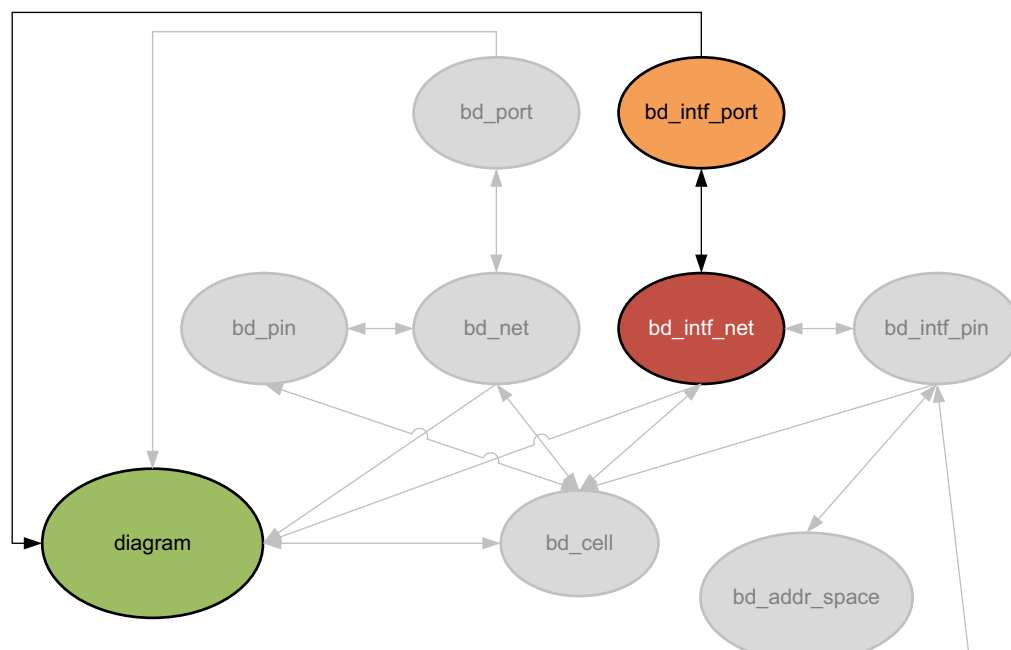

Figure 2-6: Block Design Interface Port

The block design interface port, `bd_intf_port` object, occurs in a block design, or diagram. It is connected by block design interface nets (`bd_intf_net`) to the pins of block design cells (`bd_cell`). You can query the `bd_intf_ports` of the diagram, or those connected to block design interface nets.

```
get_bd_intf_ports -of_objects [get_bd_intf_nets]
```

You can also query the interface nets connected to `bd_intf_port` objects:

```
get_bd_intf_nets -of_objects [get_bd_intf_ports CLK*]
```

Properties

The specific properties on a block design interface port object can vary depending on the type of the port. The following table lists some of the properties assigned to a clock `bd_intf_port` object, with example values:

Property	Type	Read-only	Visible	Value
CLASS	string	true	true	<code>bd_intf_port</code>
LOCATION	string	false	true	<code>1950 430</code>
MODE	string	true	true	<code>Master</code>
NAME	string	false	true	<code>ddr4_sdram</code>
PATH	string	true	true	<code>/ddr4_sdram</code>
VLNV	string	true	true	<code>xilinx.com:interface:ddr4_rtl:1.0</code>

To report the properties for a `bd_intf_port` object, you can copy and paste the following command into the Vivado Design Suite Tcl shell or Tcl console:

```
report_property -all [lindex [get_bd_intf_ports] 0]
```

BD_NET

Description

A block design net, or a `bd_net` object, connects the pins on an IP Integrator block design cell to other pins, or to external ports. The `bd_net` object connects through multiple levels of the design hierarchy, connecting block design cells. Every net has a name which identifies it in the design. All block design cells, pins, and ports connected to these nets are electrically connected.

Related Objects

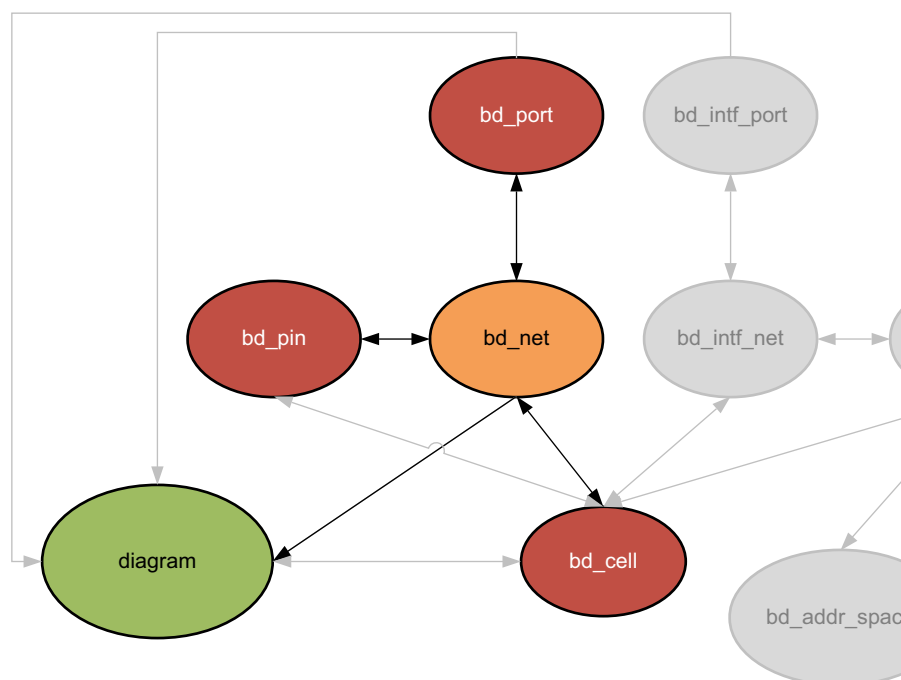

Figure 2-7: Block Design Nets

The block design net, `bd_net` object, occurs in a block design, or diagram. It is connected to ports (`bd_port`), and through pins (`bd_pin`) to block design cells (`bd_cell`) in the diagram. You can query the `bd_nets` of the `diagram`, `bd_cell`, `bd_pin`, and `bd_port` objects.

```
get_bd_nets -of_objects [get_bd_ports]
```

In addition, you can query the `bd_cells`, or the `bd_pins`, or `bd_port` objects that are connected to a specific `bd_net`:

```
get_bd_cells -of_objects [get_bd_nets clk_wiz*]
```

Properties

The properties on the bd_net object include the following:

Property	Type	Read-only	Visible	Value
CLASS	string	true	true	bd_net
NAME	string	false	true	clk_wiz_1_locked
PATH	string	true	true	/clk_wiz_1_locked

To report the properties for the bd_net object, you can copy and paste the following command into the Vivado Design Suite Tcl shell or Tcl console:

```
report_property -all [lindex [get_bd_nets] 0]
```

BD_PIN

Description

A block design pin, or a `bd_pin` object, is a point of logical connectivity on a block design cell. A block design pin allows the internal logic of a cell to be abstracted away and simplified for ease-of-use. Pins can be scalar or bus pins, and can appear on hierarchical block design cells, or leaf-level cells.

Related Objects

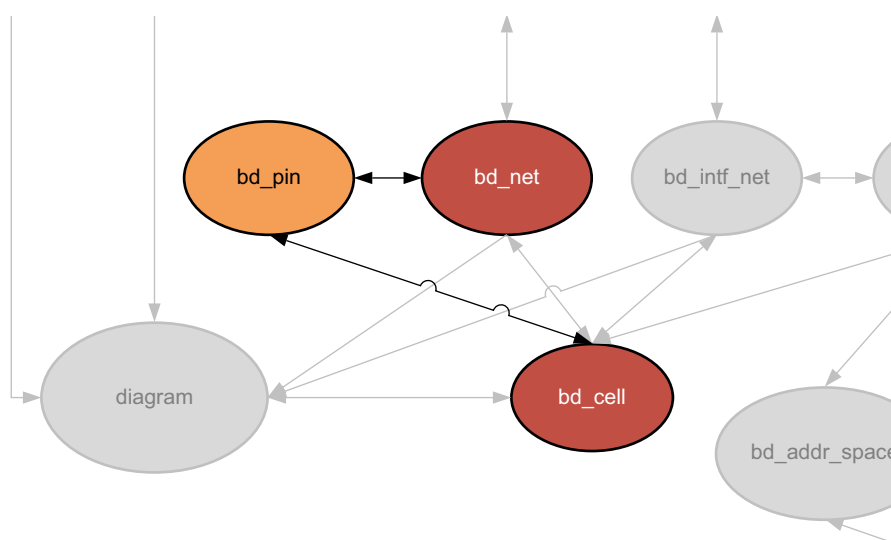

Figure 2-8: Block Design Pins

As seen in [Figure 2-8](#), a block design pin is attached to a block design cell (`bd_cell`), and can be connected to other pins or ports by a net (`bd_net`) in the block design, or diagram.

You can query the `bd_pins` of `bd_cell` and `bd_net` objects:

```
get_bd_pins -of_objects [get_bd_cells clk_wiz_1]
```

In addition, you can query the `bd_cell`, or the `bd_net`, of a specific `bd_pin`:

```
get_bd_cells -of [get_bd_pins */Reset]
```

Properties

The specific properties on a block design pin object can vary depending on the type of the pin. The following table lists some of the properties assigned to a CLK type bd_pin object in the Vivado Design Suite, with example values:

Property	Type	Read-only	Visible	Value
CLASS	string	true	true	bd_pin
DEFAULT_DRIVER	string	true	true	0000
DIR	string	true	true	0
INTF	string	true	true	TRUE
LEFT	string	true	true	3
LOCATION	string	false	true	
NAME	string	false	true	gpio_io_o
PATH	string	true	true	/axi_gpio_0/gpio_io_o
RIGHT	string	true	true	0
TYPE	string	true	true	undef

To report the properties for the bd_net object, you can copy and paste the following command into the Vivado Design Suite Tcl shell or Tcl console:

```
report_property -all [lindex [get_bd_pins */*] 0]
```

BD_PORT

Description

A block design port is a special type of hierarchical pin, a pin on the top-level diagram. In block designs, the ports are primary ports communicating the external connection of the block design or diagram to the overall FPGA design, or system-level design.

Related Objects

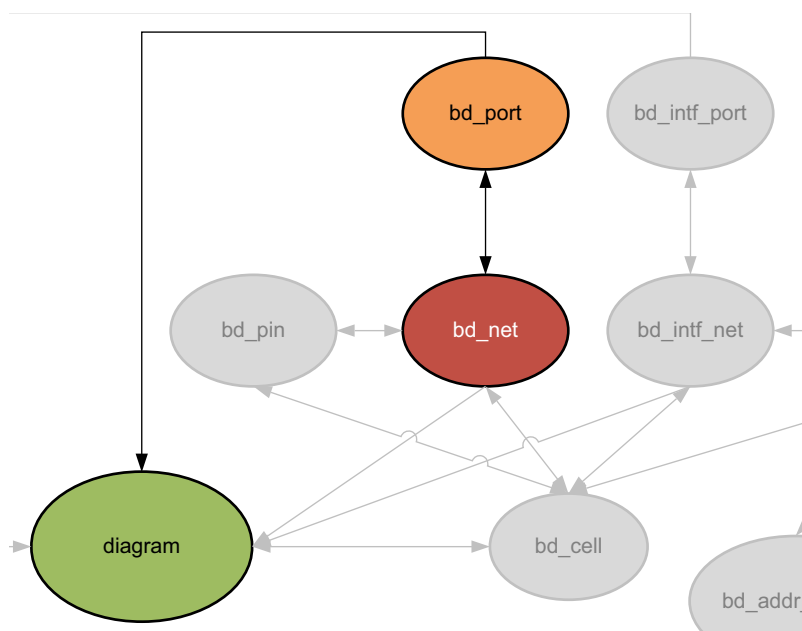

Figure 2-9: Block Design Port

The block design port, `bd_port` object, occurs in a block design, or diagram. It is connected by block design nets (`bd_net`) to the pins (`bd_pin`) of block design cells (`bd_cell`) in the diagram. You can query the `bd_ports` of the diagram, or those connected to block design nets.

```
get_bd_ports -of_objects [get_bd_nets]
```

You can also query the block design nets connected to `bd_port` objects:

```
get_bd_nets -of_objects [get_bd_ports aux_reset_in]
```

Properties

The specific properties on a block design port object can vary depending on the type of the port. The following table lists some of the properties assigned to a RESET type `bd_port` object in the Vivado Design Suite, with example values:

Property	Type	Read-only	Visible	Value
CLASS	string	true	true	bd_port
CONFIG.POLARITY	string	false	true	ACTIVE_LOW
DIR	string	true	true	I
INTF	string	true	true	FALSE
LEFT	string	false	true	
LOCATION	string	false	true	130 560
NAME	string	false	true	aux_reset_in
PATH	string	true	true	/aux_reset_in
RIGHT	string	false	true	
TYPE	string	true	true	rst

To report the properties for a `bd_port` object, you can copy and paste the following command into the Vivado Design Suite Tcl shell or Tcl console:

```
report_property -all [lindex [get_bd_ports] 0]
```

BEL

Description

Typically a BEL, or Basic Element, corresponds to leaf-cell in the netlist view of the design. BELs are device objects on the target Xilinx FPGA on which to place, or map, basic netlist objects like flip-flops, LUTs, and carry logic.

BELs are grouped together on the device in [SITE](#) objects, such as SLICES and IO Blocks (IOBs). One or more BELs can be located in a single SITE, and you can use the BEL to assign logic from the design netlist into specific locations or device resources on the target device.

There are a number of different bel types available on the different Xilinx FPGAs. The following are the types of bels found on the Kintex®-7 part, xc7k70tfbg676. The different TYPES of BELs are enumerated below:

```

AFF AFF2
BFF BFF2
BITSLICE_CONTROL_BEL
BSCAN1 BSCAN2 BSCAN3 BSCAN4 BSCAN_BSCAN
BUFCE_BUFCE BUFCE_BUFCE_LEAF BUFCE_BUFCE_ROW
BUFFER
BUFGCE_DIV_BUFGCE_DIV BUFGCTRL_BUFGCTRL BUFG_GT_BUFG_GT BUFG_GT_BUFG_GT_SYNC
BUFHCE_BUHFCE BUFIO_BUFIO BUFMRCE_BUFMRCE BUFR_BUFR
CAPTURE_CAPTURE
CARRY4 CARRY8
CFF CFF2
CFG_IO_ACCESS
DCIRESET DCIRESET_DCIRESET
DFF DFF2
DNA_PORT DNA_PORT_DNA_PORT
DSP48E1_DSP48E1 DSP_ALU DSP_A_B_DATA DSP_C_DATA DSP_MULTIPLIER DSP_M_DATA
DSP_OUTPUT DSP_PREADD DSP_PREADD_DATA
EFF EFF2
EFUSE_USR EFUSE_USR_EFUSE_USR
F7MUX F8MUX F9MUX
FFF FFF2
FF_INIT
FIFO18E1_FIFO18E1
FRAME_ECC FRAME_ECC_FRAME_ECC
GCLK_DELAY
GFF GFF2
GTHE3_CHANNEL_GTHE3_CHANNEL
GTHE3_CHANNEL_IPAD1 GTHE3_CHANNEL_IPAD2
GTHE3_CHANNEL_OPAD1 GTHE3_CHANNEL_OPAD2
GTHE3_COMMON_GTHE3_COMMON
GTHE3_COMMON_PADN GTHE3_COMMON_PADP
GTXE2_CHANNEL_GTXE2_CHANNEL GTXE2_COMMON_GTXE2_COMMON
HARD0 HARD1
HARD_SYNC_SYNC_UNIT
HFF HFF2
HPIOBDIFFINBUF_DIFFINBUF HPIOBDIFFOUTBUF_DIFFOUTBUF
HPIOB_IBUFCTRL

```

HPIOB_INBUF HPIOB_OUTBUF
 HPIOB_PAD HPIOB_PULL
 HPIO_OUTINV HPIO_VREF
 HRIODIFFINBUF_DIFFINBUF HRIODIFFOUTBUF_DIFFOUTBUF
 HRIO_IBUFCTRL
 HRIO_INBUF HRIO_OUTBUF
 HRIO_OUTINV HRIO_PAD HRIO_PULL
 IBUFDS0_GTE3 IBUFDS1_GTE3 IBUFDS_GTE2_IBUFDS_GTE2
 ICAP_BOT ICAP_ICAP ICAP_TOP
 IDELAYCTRL_IDELAYCTRL
 IDELAYE2_FINEDELAY_IDELAYE2_FINEDELAY
 IDELAYE2_IDELAYE2
 ILOGICE2_IFF
 ILOGICE3_IFF ILOGICE3_ZHOLD_DELAY
 INVERTER
 IN_FIFO_IN_FIFO
 IOB18M_INBUF_DCIEN IOB18M_OUTBUF_DCIEN IOB18M_TERM_OVERRIDE
 IOB18S_INBUF_DCIEN IOB18S_OUTBUF_DCIEN IOB18S_TERM_OVERRIDE
 IOB18_INBUF_DCIEN IOB18_OUTBUF_DCIEN IOB18_TERM_OVERRIDE
 IOB33M_INBUF_EN IOB33M_OUTBUF IOB33M_TERM_OVERRIDE
 IOB33S_INBUF_EN IOB33S_OUTBUF IOB33S_TERM_OVERRIDE
 IOB33_INBUF_EN IOB33_OUTBUF IOB33_TERM_OVERRIDE
 LUT5 LUT6
 LUT_OR_MEM5 LUT_OR_MEM6
 MASTER_JTAG
 MMCME2_ADV MMCME2_ADV MMCME3_ADV MMCM_TOP
 OBUFDS0_GTE3 OBUFDS1_GTE3
 ODELAYE2_ODELAYE2
 OLOGICE2_MISR OLOGICE2_OUTFF OLOGICE2_TFF
 OLOGICE3_MISR OLOGICE3_OUTFF OLOGICE3_TFF
 OUT_FIFO_OUT_FIFO
 PAD
 PCIE_2_1_PCIE_2_1_PCIE_3_1_PCIE_3_1
 PHASER_IN_PHY PHASER_IN_PHY PHASER_OUT_PHY PHASER_OUT_PHY
 PHASER_REF PHASER_REF
 PHY_CONTROL_PHY_CONTROL
 PLLE2_ADV PLLE2_ADV PLLE3_ADV PLL_TOP PLL_SELECT_BEL
 PMV2_PMV2
 PULL_OR_KEEP1
 RAMB18E1_RAMB18E1 RAMB18E2_U_RAMB18E2 RAMBFIFO18E2_RAMBFIFO18E2
 RAMBFIFO36E1_RAMBFIFO36E1 RAMBFIFO36E2_RAMBFIFO36E2
 REG_INIT
 RIU_OR_BEL
 RXTX_BITSLICE
 SELMUX2_1
 SLICEL_A5LUT SLICEL_A6LUT
 SLICEL_B5LUT SLICEL_B6LUT
 SLICEL_C5LUT SLICEL_C6LUT
 SLICEL_CARRY4_AMUX SLICEL_CARRY4_AXOR
 SLICEL_CARRY4_BMUX SLICEL_CARRY4_BXOR
 SLICEL_CARRY4_CMUX SLICEL_CARRY4_CXOR
 SLICEL_CARRY4_DMUX SLICEL_CARRY4_DXOR
 SLICEL_D5LUT SLICEL_D6LUT SLICEL_E5LUT
 SLICEL_E6LUT SLICEL_F5LUT SLICEL_F6LUT
 SLICEL_G5LUT SLICEL_G6LUT SLICEL_H5LUT
 SLICEL_H6LUT SLICEM_A5LUT SLICEM_A6LUT
 SLICEM_B5LUT SLICEM_B6LUT SLICEM_C5LUT
 SLICEM_C6LUT SLICEM_CARRY4_AMUX SLICEM_CARRY4_AXOR
 SLICEM_CARRY4_BMUX SLICEM_CARRY4_BXOR

SLICEM_CARRY4_CMUX SLICEM_CARRY4_CXOR
 SLICEM_CARRY4_DMUX SLICEM_CARRY4_DXOR
 SLICEM_D5LUT SLICEM_D6LUT
 SLICEM_E5LUT SLICEM_E6LUT
 SLICEM_F5LUT SLICEM_F6LUT
 SLICEM_G5LUT SLICEM_G6LUT
 SLICEM_H5LUT SLICEM_H6LUT
 STARTUP STARTUP_STARTUP
 SYSMONE1_SYSMONE1 SYSMON_IPAD1 SYSMON_IPAD2
 TRISTATE_TX_BITSLICE
 USR_ACCESS USR_ACCESS_USR_ACCESS
 XADC_XADC
 XIPHY_FEEDTHROUGH_BEL

Related Objects

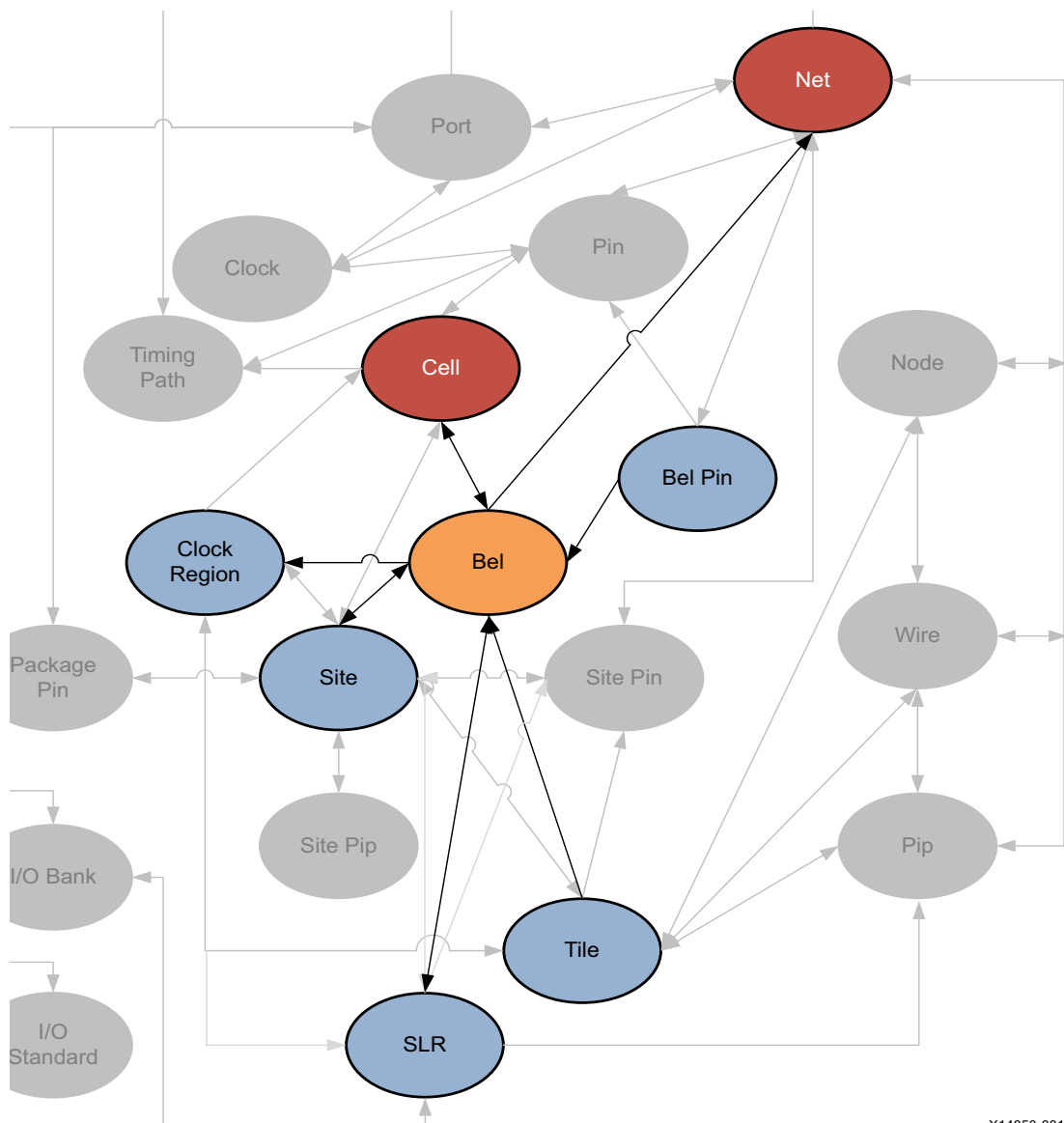

X14853-081315

Figure 2-10: BEL Objects

As seen in [Figure 2-10, page 39](#), leaf-level cells from the netlist design can be mapped onto bels on the target part. Bels are grouped in sites on the target Xilinx device, and both bels and sites are grouped into tiles and clock_regions. Each bel also has bel_pins that map to pins on the cells, and are connection points to the net netlist object.

You can query the bels of slr, tiles, sites, cells, clock_regions or nets. For example:

```
get_bels -of [get_clock_regions X1Y3]
```

You can also query the cells, sites, tiles, and bel_pins of bel objects:

```
get_cells -of [get_bels SLICE_X104Y100/B6LUT]
```

Properties

The properties assigned to bel objects vary by TYPE. The properties assigned to a BUFIO type of bel are as follows, with example values:

Property	Type	Read-only	Visible	Value
CLASS	string	true	true	bel
CONFIG.DELAY_BYPASS.VALUES	string	true	true	FALSE, TRUE
IS_RESERVED	bool	true	true	0
IS_TEST	bool	true	true	0
IS_USED	bool	true	true	0
NAME	string	true	true	BUFIO_X0Y25/BUFIO
NUM_BIDIR	int	true	true	0
NUM_CONFIGS	int	true	true	1
NUM_INPUTS	int	true	true	1
NUM_OUTPUTS	int	true	true	1
NUM_PINS	int	true	true	2
PROHIBIT	bool	false	true	0
TYPE	string	true	true	BUFIO_BUFIO

The properties assigned to BEL objects vary by TYPE. To report the properties for any of the TYPES of BEL listed above, you can use the `report_property` command:

```
report_property -all [lindex [get_bels -filter {TYPE == <BEL_TYPE>}] 0]
```

Where `<BEL_TYPE>` should be replaced by one of the listed BEL types. For example:

```
report_property -all [lindex [get_bels -filter {TYPE == SLICEM_CARRY4_AXOR}] 0]
report_property -all [lindex [get_bels -filter {TYPE == LUT5}] 0]
report_property -all [lindex [get_bels -filter {TYPE == IOB33S_OUTBUF}] 0]
```



TIP: The `report_property` command may return a warning that no objects were found if there are no related objects in the current design. Refer to the *Vivado Design Suite Tcl Command Reference Guide (UG835)* [[Ref 13](#)] for more information on this command.

BEL_PIN

Description

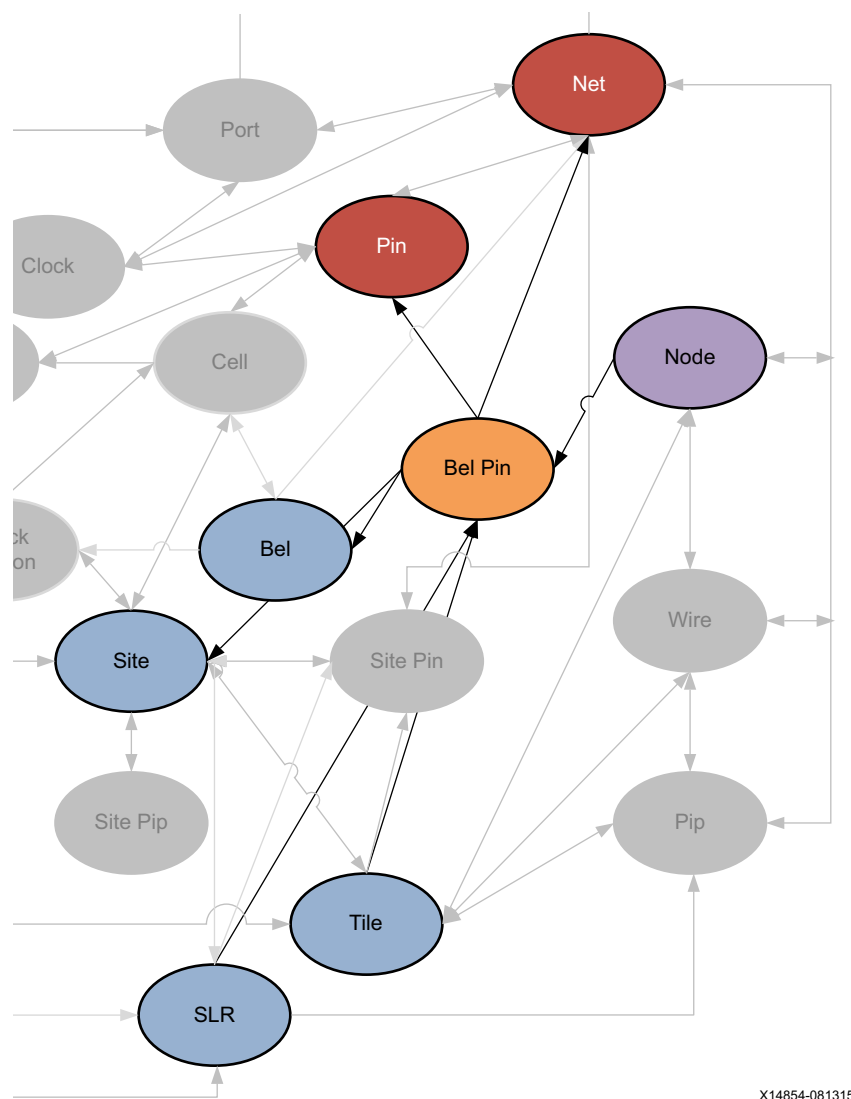

X14854-081315

Figure 2-11: BEL_PIN Objects

A BEL_PIN is a pin or connection point on a BEL object.

The BEL_PIN is a device object, associated with netlist objects such as the PIN on a logic CELL, which is the connection point for the NET.

Related Objects

As seen in [Figure 2-11](#), BEL_PIN objects are related to BEL and SITE device resources, and PIN and NET netlist objects. You can query the BEL_PINS of BELs, SITEs, PINs, or NETs by using a form of the following Tcl command:

```
get_bel_pins -of_objects [get_pins usbEngine0/usbEngineSRAM/Ram_reg_9/CLKARDCLK]
```

You can also query the SLRs, and TILEs that BEL_PINs are located in, or NODEs associated with the BEL_PIN:

```
get_slr -of_objects [get_bel_pins SLICE_X8Y176/D5LUT/WA5]
```

Properties

The properties on a BEL_PIN object include the following, with example values:

Property	Type	Read-only	Visible	Value
CLASS	string	true	true	bel_pin
DIRECTION	enum	true	true	IN
INDEX	int	true	true	1
INDEX_IN_BEL	int	true	true	1
INDEX_IN_BUS	int	true	true	1023
INDEX_IN_ELEMENT	int	true	true	1
INDEX_IN_TILE	int	true	true	65535
IS_BAD	bool	true	true	0
IS_BIDIR	bool	true	true	0
IS_CLOCK	bool	true	true	0
IS_DATA	bool	true	true	0
IS_ENABLE	bool	true	true	1
IS_INPUT	bool	true	true	1
IS_OPTIONALLY_INVERTIBLE	bool	true	false	0
IS_OUTPUT	bool	true	true	0
IS_PART_OF_BUS	bool	true	true	0
IS_RESET	bool	true	true	0
IS_SET	bool	true	true	0
IS_TEST	bool	true	true	0
IS_USED	bool	true	true	0
NAME	string	true	true	IOB_X0Y197/OUTBUF/TRI
SITE_ID	int	true	true	188
SPEED_INDEX	int	true	true	0

To report the properties for all the BEL_PINs on a specific BEL object, you can use the following FOREACH loop in the Vivado Design Suite Tcl shell or Tcl console:

```
foreach x [get_bel_pins -of [get_bels <bel_name>]] {
    puts "***** $x *****"
    report_property -all $x
}
```

Where *<bel_name>* is the name of the BEL object to report.

CELL

Description

A cell is an instance of a netlist logic object, which can either be a leaf-cell or a hierarchical cell. A leaf-cell is a primitive, or a primitive macro, with no further logic detail in the netlist. A hierarchical cell is a module or block that contains one or more additional levels of logic, and eventually concludes at leaf-cells.

Related Objects

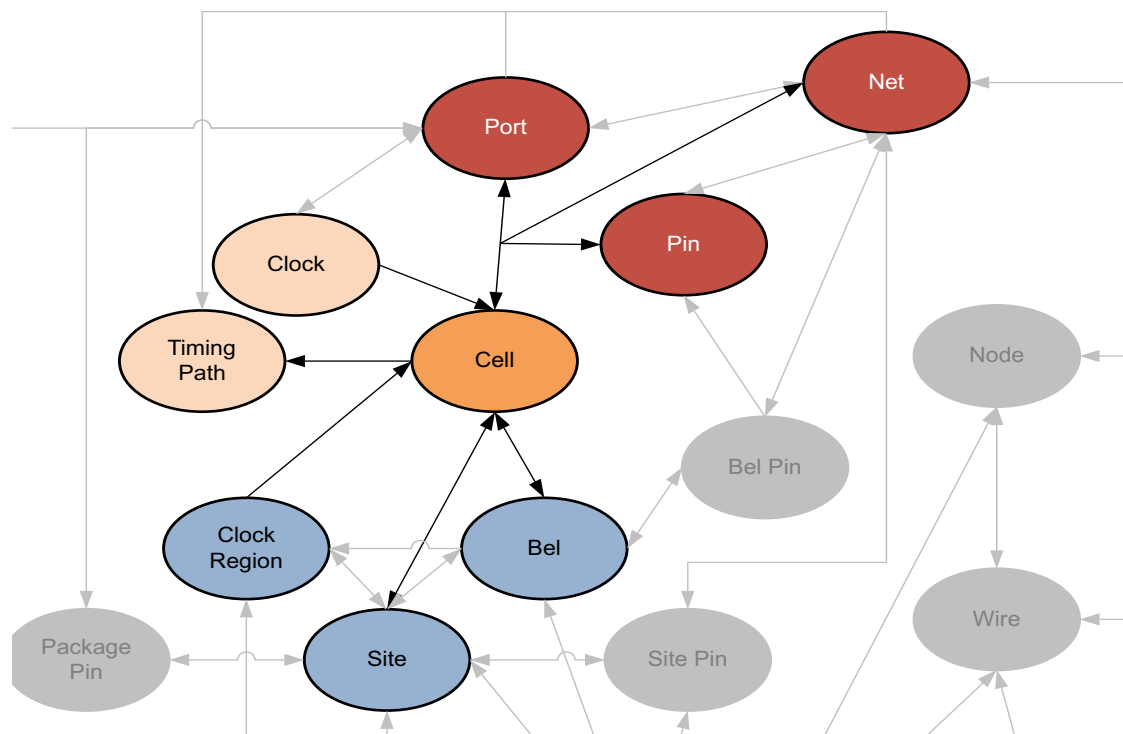

Figure 2-12: CELL Objects

As seen in [Figure 2-12](#), cells have PINs which are connected to NETs to define the external netlist. Hierarchical cells also contain PORTs that are associated with PINs, and which connect internally to NETs to define the internal netlist of the hierarchy.

Leaf CELLS are placed, or mapped, onto device resources on the target Xilinx FPGA. The CELL can be placed onto a BEL object in the case of basic logic such as flops, LUTs, and MUXes; or can be placed onto a SITE object in the case of larger logic cells such as BRAMs and DSPs. BELs are also collected into larger SITES, called SLICES, so a cell can be associated with a BEL and a SITE object. SITES are grouped into CLOCK_REGIONs and TILES.

CELLs are also associated with TIMING_PATHs in the design, and can be associated with DRC_VIOLATIONs to help you quickly locate and resolve design issues.

You can query the CELLs associated with pins, timing paths, nets, bels, clock regions, sites, or DRC violations:

```
get_cells -of [get_nets clk]
```

Properties

There are different types of leaf-cell objects, defined by the PRIMITIVE_GROUP, PRIMITIVE_SUBGROUP, and PRIMITIVE_TYPE properties as enumerated below.

Table 2-1: Cell Primitives

PRIMITIVE_GROUP	PRIMITIVE_SUBGROUP	PRIMITIVE_TYPE	
BLOCKRAM	BRAM	BLOCKRAM.BRAM.RAMB18E2	
		BLOCKRAM.BRAM.RAMB36E2	
CLB	CARRY	CLB.CARRY.CARRY8	
		CLB.LUT.LUT1	
	CLB.LUT.LUT2		
	LUT	CLB.LUT.LUT3	
		CLB.LUT.LUT4	
		CLB.LUT.LUT5	
		CLB.LUT.LUT6	
		LUTRAM	CLB.LUTRAM.RAM32M
			CLB.LUTRAM.RAM32M16
	CLB.LUTRAM.RAM32X1D		
	MUXF		CLB.MUXF.MUXF7
		CLB.MUXF.MUXF8	
	SRL	CLB.SRL.SRL16E	
		CLB.SRL.SRLC16E	
CLB.SRL.SRLC32E			
Others	CLB.others.LUT6_2		
CLOCK	BUFFER	CLOCK.BUFFER.BUFGCE	
		CLOCK.BUFFER.BUFGCE_DIV	
	PLL	CLOCK.PLL.MMCME3_ADV	
		CLOCK.PLL.PLLE3_ADV	
CONFIGURATION	BSCAN	CONFIGURATION.BSCAN.BSCANE2	
I/O	BIDIR_BUFFER	I/O.BIDIR_BUFFER.IOBUFDS	

PRIMITIVE_GROUP	PRIMITIVE_SUBGROUP	PRIMITIVE_TYPE
		I/O.BITSLICE.BITSLICE_CONTROL
	BITSLICE	I/O.BITSLICE.RIU_OR
		I/O.BITSLICE.RXTX_BITSLICE
		I/O.BITSLICE.TX_BITSLICE_TRI
		I/O.INPUT_BUFFER.HPIO_VREF
	INPUT_BUFFER	I/O.INPUT_BUFFER.IBUF
		I/O.INPUT_BUFFER.IBUFDS
		I/O.OUTPUT_BUFFER.IOBUFE3
	OUTPUT_BUFFER	I/O.OUTPUT_BUFFER.OBUF
		I/O.OUTPUT_BUFFER.OBUFDS
		others.others.others
OTHERS	others	OTHERS.others.AND2B1L
		OTHERS.others.GND
		OTHERS.others.VCC
		REGISTER.SDR.FDCE
REGISTER	SDR	REGISTER.SDR.FDPE
		REGISTER.SDR.FDRE
		REGISTER.SDR.FDSE
RTL_GATE	buf	RTL_GATE.buf.RTL_INV
		RTL_GATE.logical.RTL_AND
	logical	RTL_GATE.logical.RTL_OR
		RTL_GATE.logical.RTL_XOR
RTL_MEMORY	ram	RTL_MEMORY.ram.RTL_RAM
	rom	RTL_MEMORY.rom.RTL_ROM
RTL_MUX	mux	RTL_MUX.mux.RTL_MUX
		RTL_OPERATOR.arithmetic.RTL_ADD
RTL_OPERATOR	arithmetic	RTL_OPERATOR.arithmetic.RTL_MULT
		RTL_OPERATOR.arithmetic.RTL_SUB
	equality	RTL_OPERATOR.equality.RTL_EQ
	shift	RTL_OPERATOR.shift.RTL_RSHIFT
REGISTER	flop	RTL_REGISTER.flop.RTL_REG

All cells have a common set of properties; but each cell GROUP, SUBGROUP, and TYPE may also have unique properties. You can report the properties for specific types of CELL objects by filtering on the PRIMITIVE_GROUP, PRIMITIVE_SUBGROUP or PRIMITIVE_TYPE property value.

PRIMITIVE_TYPE is an enumerated property, the defined values of which can be returned with the `list_property_value` command:

```
list_property_value -class cell PRIMITIVE_TYPE
```

However, a design will probably not contain cells for each defined PRIMITIVE_TYPE. The following Tcl code searches hierarchically through a design and returns unique occurrences of the PRIMITIVE_TYPE property for all the cells in the design.

```
foreach x [get_cells -hierarchical *] {  
    lappend primTypes [get_property PRIMITIVE_TYPE $x] }  
join [lsort -unique $primTypes] \n
```

From the returned list, `$primTypes`, you can report the properties for a specific PRIMITIVE_TYPE using the following command:

```
report_property -all [lindex [get_cells -hier -filter {PRIMITIVE_TYPE == <val>}] 0]
```

Where `<val>` represents the PRIMITIVE_TYPE of interest. For example, to return the properties of the BLOCKRAM.BRAM.RAM18E2 type cell:

```
report_property -all [lindex [get_cells -hier -filter {PRIMITIVE_TYPE ==  
"BLOCKRAM.BRAM.RAM18E2"}] 0]
```



TIP: The `report_property` command may return a warning that no objects were found if there are no related objects in the current design. Refer to the *Vivado Design Suite Tcl Command Reference Guide* (UG835) [Ref 13] for more information on this command.

You can also return the properties from a hierarchical cell using the following Tcl command:

```
report_property -all [lindex [get_cells -hier -filter {!IS_PRIMITIVE}] 0]
```

Of course, you can also simply return the properties for the specific cell of interest:

```
report_property -all [get_cells <cell_name>]
```

CLOCK

Description

CLOCK objects provide the Vivado Design Suite a time reference for reliably transferring data from register to register. The Vivado timing engine uses the properties of the CLOCK objects to compute the setup and hold requirements of the design and report the design timing margin by means of the slack computation. You must properly define the CLOCK objects in order to get the maximum timing path coverage with the best accuracy.

A clock is defined with PERIOD and WAVEFORM properties. The period is specified in nanoseconds and defines the length of the clock cycle. It corresponds to the time over which the waveform repeats. The waveform is the list of rising edge and falling edge absolute times, in nanoseconds, within the clock period. Refer to *Vivado Design Suite User Guide: Using Constraints* (UG903) [Ref 19] for more information on defining clocks.

The period and waveform properties represent the ideal characteristics of a clock. When entering the FPGA and propagating through the clock tree, the clock edges are delayed and become subject to variations induced by noise and hardware behavior. These characteristics are called clock network latency and clock uncertainty. By default, the Vivado Design Suite treats all clocks as propagated clocks, or non-ideal, in order to provide an accurate slack value which includes clock tree insertion delay and uncertainty.

The Vivado tools support a variety of different types of clocks:

- **Primary clocks** - A primary clock is a system-level clock that enters the Vivado design through a primary input port or a gigabit transceiver pin. A primary clock is defined by the `create_clock` command. The design source of a primary clock defines the time zero and point of propagation used by the Vivado timing engine when computing delay values.
- **Virtual clocks** - A virtual clock is a CLOCK object that is not physically attached to any netlist elements in the design. A virtual clock is defined by the `create_clock` command, without specifying a source object to assign the clock to.
- **Generated clocks** - Generated clocks are driven inside the design by special cells called Clock Modifying Blocks (for example, an MMCM), or by some user logic. Generated clocks are derived from a master clock by the `create_generated_clock` command, and include the `IS_GENERATED` property. Instead of specifying the period and waveform of generated clocks, you must describe how the modifying circuitry transforms the master clock.

Clocks use dedicated device resources to propagate through the design. Refer to *7 Series FPGAs Clocking Resources User Guide* (UG472) [Ref 3] or *UltraScale Architecture Clocking Resources User Guide* (UG572) [Ref 9] for more information on clock resources.

Related Objects

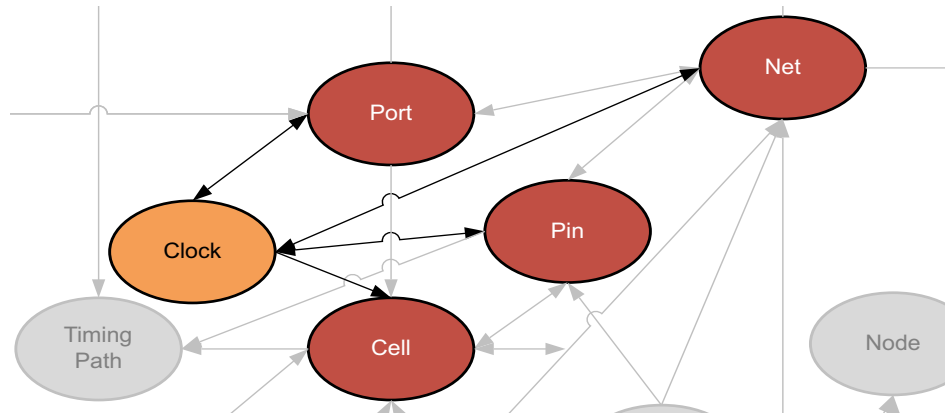

Figure 2-13: CLOCK Objects

CLOCK objects are related to the PORTS, NETS, CELLS, or PINs that are their source, as defined by the `create_clock` command. You can query the clocks associated with a netlist object using the `get_clock` or `get_generated_clocks` commands:

```
get_clocks -of_objects [get_ports <port_name>]
```

You can also query the netlist objects (NETS, PINs, PORTs) associated with clocks:

```
get_nets -of_objects [get_clocks]
```

Properties

The properties on the clock object include the following, with example values:

Property	Type	Read-only	Visible	Value
CLASS	string	true	true	clock
DIVIDE_BY	int	true	true	
DUTY_CYCLE	double	true	true	
EDGES	int*	true	true	
EDGE_SHIFT	double*	true	true	
FILE_NAME	string	true	true	
INPUT_JITTER	double	true	true	0.000
IS_GENERATED	bool	true	true	1
IS_INVERTED	bool	true	true	0
IS_PROPAGATED	bool	true	true	1
IS_RENAMED	bool	true	true	0
IS_USER_GENERATED	bool	true	true	0
IS_VIRTUAL	bool	true	true	0
LINE_NUMBER	int	true	true	
MASTER_CLOCK	clock	true	true	sysClk
MULTIPLY_BY	int	true	true	1
NAME	string	true	true	usbClk
PERIOD	double	true	true	10.000
SOURCE	pin	true	true	clkgen/mmc Adv_inst/CLKIN1
SOURCE_PINS	string*	true	true	clkgen/mmc Adv_inst/CLKOUT2
SYSTEM_JITTER	double	true	true	0.050
WAVEFORM	double*	true	true	0.000 5.000

You can use the `report_property` command to report the properties of a CLOCK object. Refer to the *Vivado Design Suite Tcl Command Reference Guide* (UG835) [Ref 13] for more information. To report the properties for a specific clock in the design, you can use the following command in the Vivado Design Suite Tcl shell or Tcl console:

```
report_property -all [get_clocks <clock_name>]
```

Where `<clock_name>` is the name of the clock to report.

CLOCK_REGION

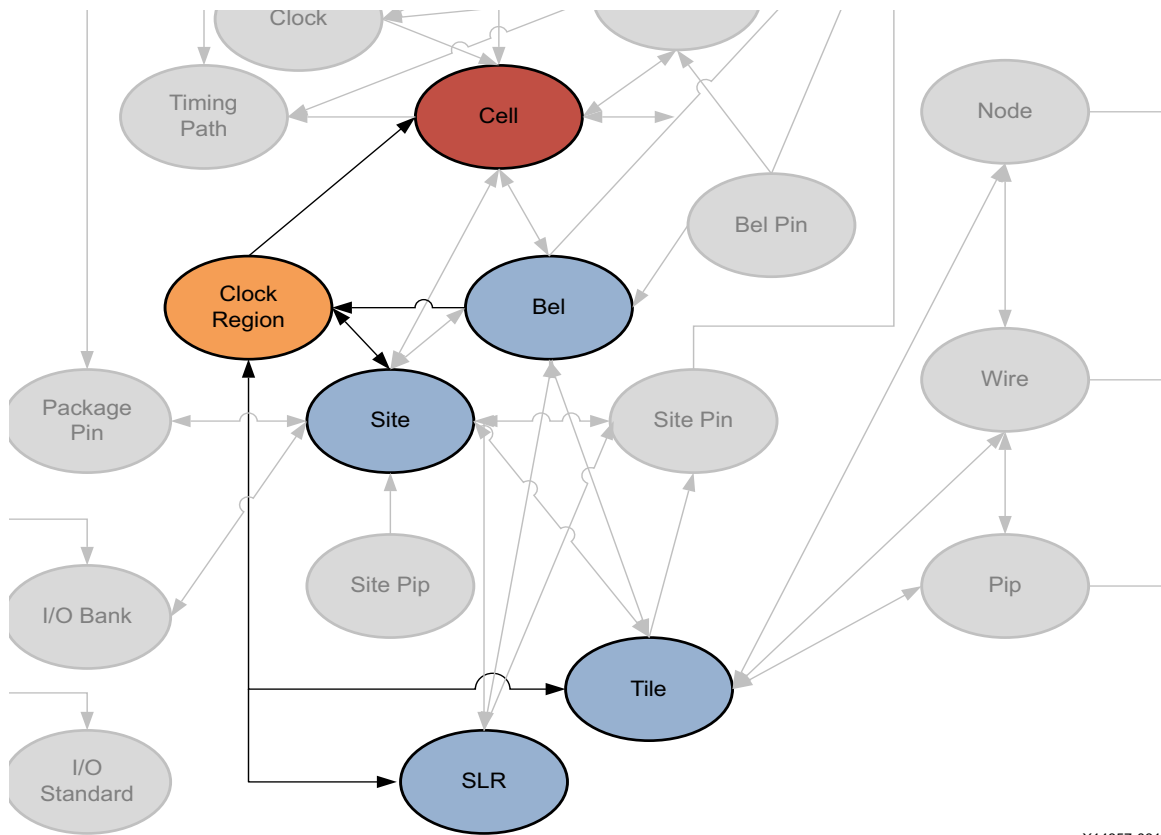

X14857-081315

Figure 2-14: CLOCK_REGION Objects

Description

For clocking purposes, each device is divided into clock regions. A CLOCK_REGION is a device object identifying an area of the Xilinx FPGA or device that is served by a set of clocking resources. A clock region contains configurable logic blocks (CLBs), DSP slices, block RAMs, interconnect, and associated clocking.

The number of clock regions varies with the size of the device. UltraScale devices are divided into columns and rows of segmented clock regions. These clock regions differ from previous families because they are arranged in tiles and do not span half the width of a device.

For UltraScale devices the height of a clock region is 60 CLBs, 24 DSP slices, and 12 block RAMs, with a horizontal clock spine (HCS) at its center. There are 52 I/Os per bank and four Gigabit transceivers (GTs) that are pitch matched to the clock regions.

For 7 series devices, the clock region contains 50 CLBs and one I/O bank with 50 I/Os, and a horizontal clock row (HROW) at its center.

The I/O banks in clock regions have clock capable pins that bring user clocks onto the clock routing resources within the clock region.

Refer to *7 Series FPGAs Clocking Resources User Guide* (UG472) [Ref 3] or *UltraScale Architecture Clocking Resources User Guide* (UG572) [Ref 9] for more information on clock regions and the resources they contain.

Related Objects

CLOCK_REGION objects are associated with super-logic regions (SLR) on the device that the region is found in, or the TILE, SITE, or PACKAGE_BANK device objects found in the clock region. Additionally you can get the CLOCK_REGION that CELL netlist objects have been placed into.

You can query the CLOCK_REGION of an associated object with a Tcl command similar to the following, which returns the clock region that the specified cell is placed into:

```
get_clock_regions -of [get_cells usbEngine0/u1/u0/crc16_sum_reg[7]]
```

In addition, you can query the SLR, TILE, SITE, BEL, and IO_BANK device objects associated with, or found in, the CLOCK_REGION. For example, the following Tcl command returns the I/O Banks in the same clock region that the specified cell is placed into:

```
get_iobanks -of_objects [get_clock_regions -of \
[get_cells usbEngine0/u1/u0/crc16_sum_reg[7]]]
```

Properties

You can use the `report_property` command to report the properties of a CLOCK_REGION. Refer to the *Vivado Design Suite Tcl Command Reference Guide* (UG835) [Ref 13] for more information.

The properties on the clock_region object include the following, with example values:

Property	Type	Read-only	Visible	Value
BOTTOM_RIGHT_TILE	string	true	true	NULL_X116Y105
CLASS	string	true	true	clock_region
COLUMN_INDEX	int	true	true	1
FULL_NAME	string	true	true	CLOCKREGION_X1Y2
NAME	string	true	true	X1Y2
NUM_SITES	int	true	true	1418
ROW_INDEX	int	true	true	2
TOP_LEFT_TILE	string	true	true	CLBL_L_X26Y149

To report the properties for a specific CLOCK_REGION, you can copy and paste the following command into the Vivado Design Suite Tcl shell or Tcl console:

```
report_property -all [get_clock_regions <name>]
```

Where `<name>` is the name of the clock region to report.

DIAGRAM

Description

A block design (.bd), is a complex system of interconnected IP cores created in the IP integrator of the Vivado Design Suite. The Vivado IP integrator lets you create complex system designs by instantiating and interconnecting IP from the Vivado IP catalog. A block design is a hierarchical design which can be written to a file (.bd) on disk, but is stored as a **diagram** object within the Vivado tool memory.

Block designs are typically constructed at the interface level for increased productivity, but may also be edited at the port or pin level, to provide greater control. A Vivado Design Suite project may incorporate multiple diagrams, at different levels of the design hierarchy, or may consist of a single diagram as the top-level design.

Related Objects

As seen in [Figure 1-2, page 13](#), the diagram object contains other IP integrator block design (bd) objects such as bd_cells, bd_nets, and bd_ports. The relationship between these objects is similar to the relationship between the standard netlist objects of cells, pins, and nets. You can get each object of the Block Design: cell, address space, address segment, net, pin, port, interface net, interface pin, and interface port from a specified diagram object.

For instance, get the nets of the Block Design with the following Tcl command:

```
get_bd_nets -of_objects [current_bd_design]
```

Properties

The following table lists the properties assigned to a diagram object in the Vivado Design Suite, with example values:

Property	Type	Read-only	Visible	Value
CLASS	string	true	true	diagram
COLOR	string	false	true	
FILE_NAME	string	true	true	design_1.bd
NAME	string	true	true	design_1
USE_IP_SHARED_DIR	bool	false	true	1

The properties of the diagram object can be reported using the following command:

```
report_property -all [lindex [get_bd_designs] 0]
```

HW_AXI

Description

The JTAG to AXI Master core, or `hw_axi` object, is a customizable IP core that works as an AXI Master to drive AXI transactions and drive AXI signals on the Xilinx FPGA, `hw_device` object. The AXI Master core supports AXI4 interfaces and AXI4-Lite protocol. The width of AXI data bus is configurable. The AXI core can drive AXI4-Lite or AXI4 Memory mapped Slave through an AXI4 interconnect. The core can also be connected to interconnect as the master.

The JTAG to AXI Master core must be instantiated in the RTL code, from the Xilinx IP catalog. Detailed documentation on the VIO core can be found in the *LogiCORE IP JTAG to AXI Master Product Guide* (PG174) [Ref 29].

Related Objects

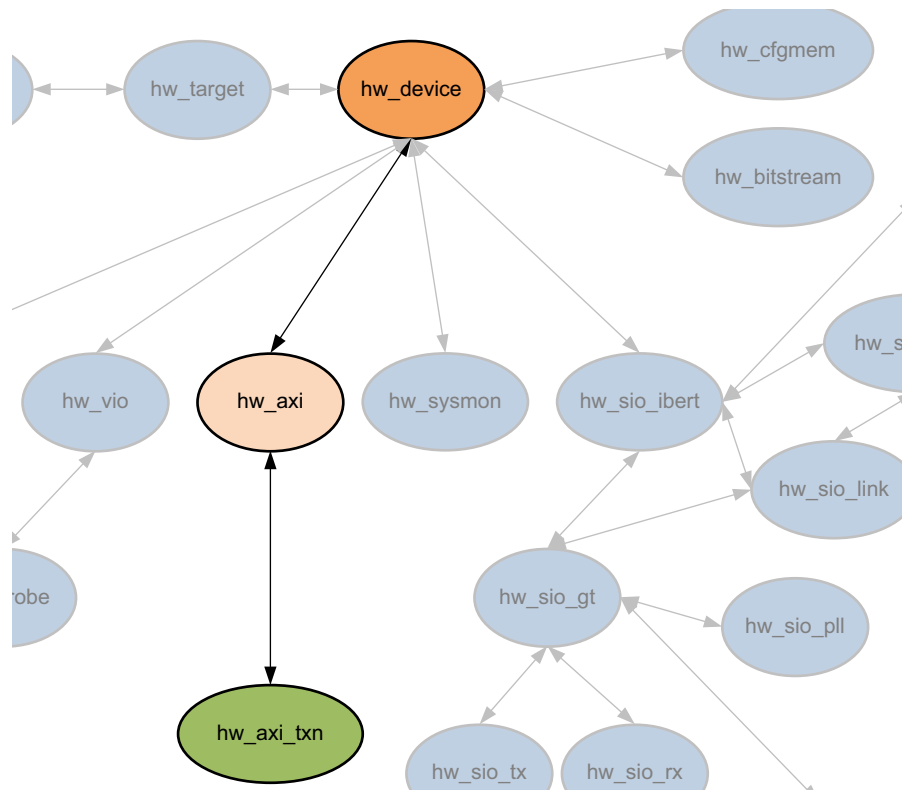

Figure 2-15: Hardware AXI Objects

The AXI Master cores can be added to a design in the RTL source files from the Xilinx IP catalog. AXI cores can be found in the synthesized netlist design using the `get_debug_cores` command. These are not the hardware AXI Master core objects, `hw_axi`, found in the Hardware Manager feature of the Vivado Design Suite, though they are related.

The HW_AXI core can be found in the Hardware Manager on the programmed hardware device object, `hw_device`. You can query the `hw_axi` of the `hw_device` as follows:

```
get_hw_axis -of [get_hw_devices]
```

In addition, the HW_AXI core has AXI transactions associated with the core that can be queried as follows:

```
get_hw_axi_txns -of [get_hw_axis]
```

Properties

You can use the `report_property` command to report the properties assigned to a HW_AXI core. Refer to the *Vivado Design Suite Tcl Command Reference Guide* (UG835) [Ref 13] for more information. The properties assigned to HW_AXI objects include the following, with examples:

Property	Type	Read-only	Visible	Value
CLASS	string	true	true	hw_axi
HW_CORE	string	true	false	core_8
NAME	string	true	true	hw_axi_1
PROTOCOL	string	true	true	AXI4_Full
STATUS.AXI_READ_BUSY	bool	true	true	0
STATUS.AXI_READ_DONE	bool	true	true	0
STATUS.AXI_WRITE_BUSY	bool	true	true	0
STATUS.AXI_WRITE_DONE	bool	true	true	0
STATUS.BRESP	string	true	true	OKAY
STATUS.RRESP	string	true	true	OKAY

To report the properties for a specific HW_AXI, you can copy and paste the following command into the Vivado Design Suite Tcl shell or Tcl console:

```
report_property -all [lindex [get_hw_axis] 0]
```

HW_BITSTREAM

Description

A hardware bitstream object `hw_bitstream`, that is created from a bitstream file, to associate with a hardware device object, `hw_device`, in the Hardware Manager feature of the Vivado Design Suite.

The bitstream file is created from a placed and routed design with the `write_bitstream` command. The hardware bitstream object is created manually from a bitstream file with the `create_hw_bitstream` command, or automatically created when the hardware device is programmed with the `program_hw_device` command.

The `hw_bitstream` object is associated with the specified `hw_device` through the `PROGRAM.HW_BITSTREAM` property on the device. This property is automatically set by the `create_hw_bitstream` command. The `PROGRAM.FILE` property includes the file path of the specified bitstream file.

Related Objects

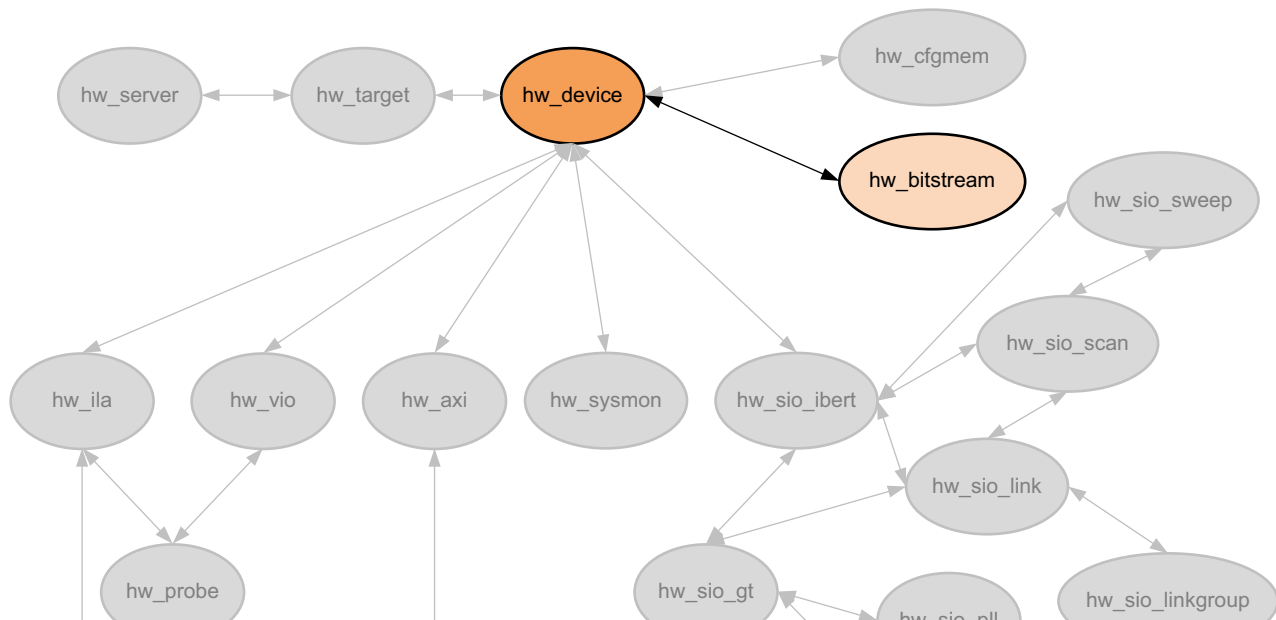

Figure 2-16: Hardware Bitstream Objects

The `hw_bitstream` object is associated with a `hardware_device`, through the `PROGRAM.BITSTREAM` property. You can query the `hw_bitstream` object using the `get_property` command to return the object in the property as follows:

```
get_property PROGRAM.HW_BITSTREAM [current_hw_device]
```

Properties

You can use the `report_property` command to report the properties assigned to a hardware bitstream object. Refer to the *Vivado Design Suite Tcl Command Reference Guide* (UG835) [Ref 13] for more information. The specific properties of the `hw_bitstream` object include the following, with example values:

Property	Type	Read-only	Visible	Value
CLASS	string	true	true	hw_bitstream
DESIGN	string	true	true	ks_counter2
DEVICE	string	true	true	xc7k325t
NAME	string	true	true	
				C:/Data/ks_counter2_k7/project_1/project_1.runs/impl_1/ks_counter2.bit
PART	string	true	true	xc7k325tffg900-3
SIZE	string	true	true	11443612
USERCODE	string	true	true	0xFFFFFFFF

To report the properties for a `hw_bitstream` object, you can use the `get_property` command to return the object defined in the `PROGRAM.HW_BITSTREAM` property on a `hw_device` in the Vivado logic analyzer. You can copy and paste the following command into the Vivado Design Suite Tcl shell or Tcl console:

```
report_property -all [get_property PROGRAM.HW_BITSTREAM [current_hw_device]]
```

HW_CFGMEM

Description

Xilinx FPGAs are configured by loading design-specific configuration data, in the form of a bitstream file, into the internal memory of the hw_device. The hw_cfgmem defines a flash memory device used for configuring and booting the Xilinx FPGA in the Hardware Manager feature of the Vivado Design Suite.

The hw_cfgmem object is created using the `create_hw_cfgmem` command. Once the hw_cfgmem object is created, and associated with the hw_device, the configuration memory can be programmed with the bitstream and other data using the `program_hw_cfgmem` command.

Related Objects

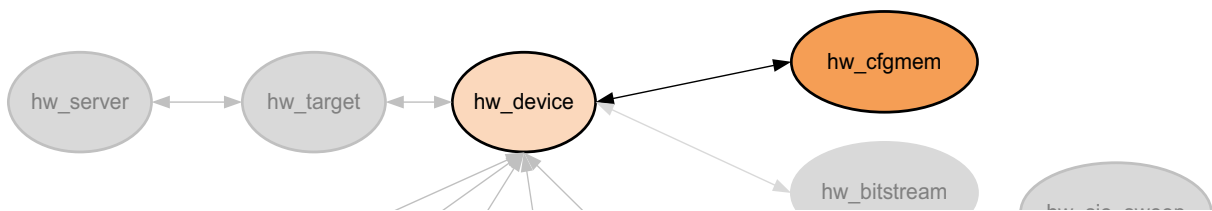

Figure 2-17: Hardware CFGMEM Objects

The hw_cfgmem object is associated with the specified hw_device object through the PROGRAM.HW_CFGMEM property on the device object. To work with the hw_cfgmem object, use the `get_property` command to obtain the object from a hw_device:

```
get_property PROGRAM.HW_CFGMEM [current_hw_device]
```

Properties

You can use the `report_property` command to report the properties assigned to a hw_cfgmem object. Refer to the *Vivado Design Suite Tcl Command Reference Guide* (UG835) [Ref 13] for more information. The properties on the hw_cfgmem object include the following, with example values:

Property	Type	Read-only	Visible	Value
CFGMEM_NAME	string	true	true	28f00ap30t-bpi-x16_0
CFGMEM_PART	cfgmem_part	false	true	28f00ap30t-bpi-x16
CLASS	string	true	true	hw_cfgmem
NAME	string	false	true	28f00ap30t-bpi-x16_0
PROGRAM.ADDRESS_RANGE	string	false	true	use_file
PROGRAM.BIN_OFFSET	int	false	true	0
PROGRAM.BLANK_CHECK	bool	false	true	0
PROGRAM.BPI_RS_PINS	string	false	true	NONE

PROGRAM.CFG_PROGRAM	bool	false	true	0
PROGRAM.ERASE	bool	false	true	1
PROGRAM.FILE	string	false	true	
C:/Data/Vivado_Debug/kc705_8led.mcs				
PROGRAM.FILE_1	string	false	true	
C:/Data/Vivado_Debug/kc705_8led.mcs				
PROGRAM.FILE_2	string	false	true	
PROGRAM.VERIFY	bool	false	true	0
PROGRAM.ZYNQ_FSBL	string	false	true	

To report the properties for a hw_cfgmem object, you can copy and paste the following command into the Vivado Design Suite Tcl shell or Tcl console when the Hardware Manager feature is open:

```
report_property -all [get_property PROGRAM.HW_CFGMEM [current_hw_device] ]
```

HW_DEVICE

Description

Within the Hardware Manager feature of the Vivado Design Suite, each hardware target can have one or more Xilinx FPGA devices to program, or to use for debugging purposes. The `hw_device` object is the physical part on the `hw_target` opened through the `hw_server`. The current device is specified or returned by the `current_hw_device` command.

Related Objects

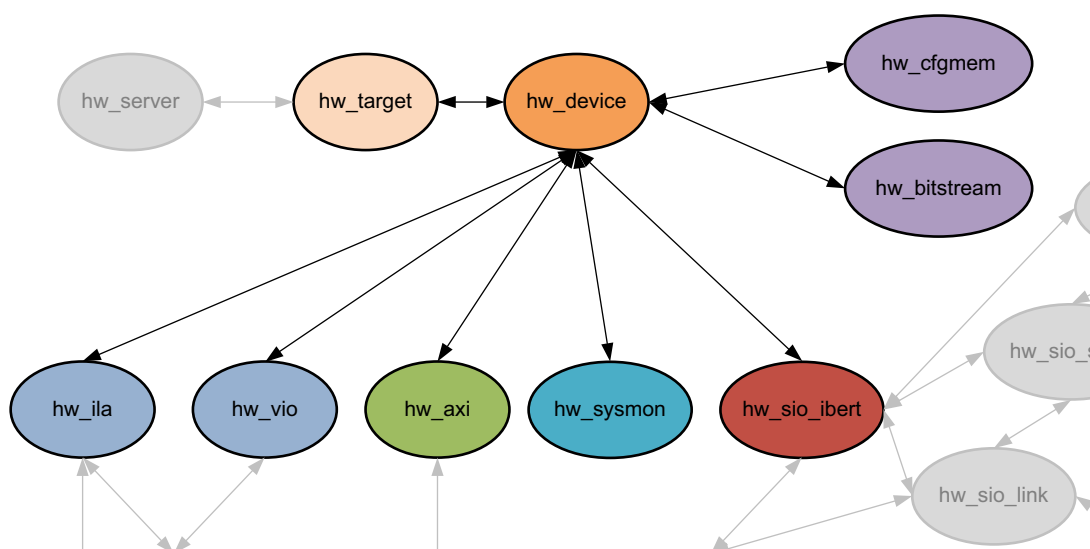

Figure 2-18: Hardware Device Objects

Hardware devices are associated with hardware targets, and can be queried as objects of the `hw_target` object:

```
get_hw_devices -of [get_hw_targets]
```

You can also query the debug cores programmed onto a hardware device object:

```
get_hw_ilas -of [current_hw_device]
```

Properties

The properties on the `hw_device` object may vary depending on the target part you have selected. You can use the `report_property` command to report the properties assigned to a `hw_device` object. Refer to the *Vivado Design Suite Tcl Command Reference Guide* (UG835) [Ref 13] for more information.

The properties assigned to the hw_device object include the following, with property type:

Property	Type
CLASS	string
DID	string
IDCODE	string
INDEX	int
IR_LENGTH	int
IS_SYSMON_SUPPORTED	bool
MASK	int
NAME	string
PART	string
PROBES.FILE	string
PROGRAM.FILE	string
PROGRAM.HW_BITSTREAM	hw_bitstream
PROGRAM.HW_CFGMEM	hw_cfgmem
PROGRAM.HW_CFGMEM_BITFILE	string
PROGRAM.HW_CFGMEM_TYPE	string
PROGRAM.IS_SUPPORTED	bool
PROGRAM.OPTIONS	string
REGISTER.BOOT_STATUS	string
REGISTER.BOOT_STATUS.BIT00_0_STATUS_VALID	string
REGISTER.BOOT_STATUS.BIT01_0_FALLBACK	string
REGISTER.BOOT_STATUS.BIT02_0_INTERNAL_PROG	string
REGISTER.BOOT_STATUS.BIT03_0_WATCHDOG_TIMEOUT_ERROR	string
REGISTER.BOOT_STATUS.BIT04_0_ID_ERROR	string
REGISTER.BOOT_STATUS.BIT05_0_CRC_ERROR	string
REGISTER.BOOT_STATUS.BIT06_0_WRAP_ERROR	string
REGISTER.BOOT_STATUS.BIT07_RESERVED	string
REGISTER.BOOT_STATUS.BIT08_1_STATUS_VALID	string
REGISTER.BOOT_STATUS.BIT09_1_FALLBACK	string
REGISTER.BOOT_STATUS.BIT10_1_INTERNAL_PROG	string
REGISTER.BOOT_STATUS.BIT11_1_WATCHDOG_TIMEOUT_ERROR	string
REGISTER.BOOT_STATUS.BIT12_1_ID_ERROR	string
REGISTER.BOOT_STATUS.BIT13_1_CRC_ERROR	string
REGISTER.BOOT_STATUS.BIT14_1_WRAP_ERROR	string
REGISTER.BOOT_STATUS.BIT15_RESERVED	string
REGISTER.CONFIG_STATUS	string
REGISTER.CONFIG_STATUS.BIT00_CRC_ERROR	string
REGISTER.CONFIG_STATUS.BIT01_DECRYPTOR_ENABLE	string
REGISTER.CONFIG_STATUS.BIT02_PLL_LOCK_STATUS	string
REGISTER.CONFIG_STATUS.BIT03_DCI_MATCH_STATUS	string
REGISTER.CONFIG_STATUS.BIT04_END_OF_STARTUP_(EOS)_STATUS	string
REGISTER.CONFIG_STATUS.BIT05_GTS_CFG_B_STATUS	string
REGISTER.CONFIG_STATUS.BIT06_GWE_STATUS	string

REGISTER.CONFIG_STATUS.BIT07_GHIGH_STATUS	string
REGISTER.CONFIG_STATUS.BIT08_MODE_PIN_M[0]	string
REGISTER.CONFIG_STATUS.BIT09_MODE_PIN_M[1]	string
REGISTER.CONFIG_STATUS.BIT10_MODE_PIN_M[2]	string
REGISTER.CONFIG_STATUS.BIT11_INIT_B_INTERNAL_SIGNAL_STATUS	string
REGISTER.CONFIG_STATUS.BIT12_INIT_B_PIN	string
REGISTER.CONFIG_STATUS.BIT13_DONE_INTERNAL_SIGNAL_STATUS	string
REGISTER.CONFIG_STATUS.BIT14_DONE_PIN	string
REGISTER.CONFIG_STATUS.BIT15_IDCODE_ERROR	string
REGISTER.CONFIG_STATUS.BIT16_SECURITY_ERROR	string
REGISTER.CONFIG_STATUS.BIT17_SYSTEM_MONITOR_OVER-TEMP_ALARM_S TATUS	string
REGISTER.CONFIG_STATUS.BIT18_CFG_STARTUP_STATE_MACHINE_PHASE	string
REGISTER.CONFIG_STATUS.BIT21_RESERVED	string
REGISTER.CONFIG_STATUS.BIT25_CFG_BUS_WIDTH_DETECTION	string
REGISTER.CONFIG_STATUS.BIT27_HMAC_ERROR	string
REGISTER.CONFIG_STATUS.BIT28_PUDC_B_PIN	string
REGISTER.CONFIG_STATUS.BIT29_BAD_PACKET_ERROR	string
REGISTER.CONFIG_STATUS.BIT30_CFGBVS_PIN	string
REGISTER.CONFIG_STATUS.BIT31_RESERVED	string
REGISTER.IR	string
REGISTER.IR.BIT0_ALWAYS_ONE	string
REGISTER.IR.BIT1_ALWAYS_ZERO	string
REGISTER.IR.BIT2_ISC_DONE	string
REGISTER.IR.BIT3_ISC_ENABLED	string
REGISTER.IR.BIT4_INIT_COMPLETE	string
REGISTER.IR.BIT5_DONE	string
REGISTER.USERCODE	string
SET_UNKNOWN_DEVICE	bool
USER_CHAIN_COUNT	string

To report the properties for a hw_device, you can copy and paste the following command into the Vivado Design Suite Tcl shell or Tcl console:

```
report_property -all [lindex [get_hw_devices] 0]
```

HW_ILA

Description

The Integrated Logic Analyzer (ILA) debug core allows you to perform in-system monitoring of signals in the implemented design through debug probes on the core. You can configure the ILA core to trigger in real-time on specific hardware events, and capture data on the probes at system speeds.

ILA debug cores can be added to a design by instantiating an ILA core from the IP catalog into the RTL design, or using the `create_debug_core` Tcl command to add the ILA core to the synthesized netlist. Refer to *Vivado Design Suite User Guide: Programming and Debugging* (UG908) [Ref 23] for more information on adding ILA debug cores to the design.

After generating a bitstream from the design, and programming the device with the `program_hw_devices` command, the ILA debug cores in the design are accessible from the Hardware Manager using the `get_hw_ilas` command. The debug probes assigned to the ILA debug cores in the design can be returned with the `get_hw_probes` command.

Related Objects

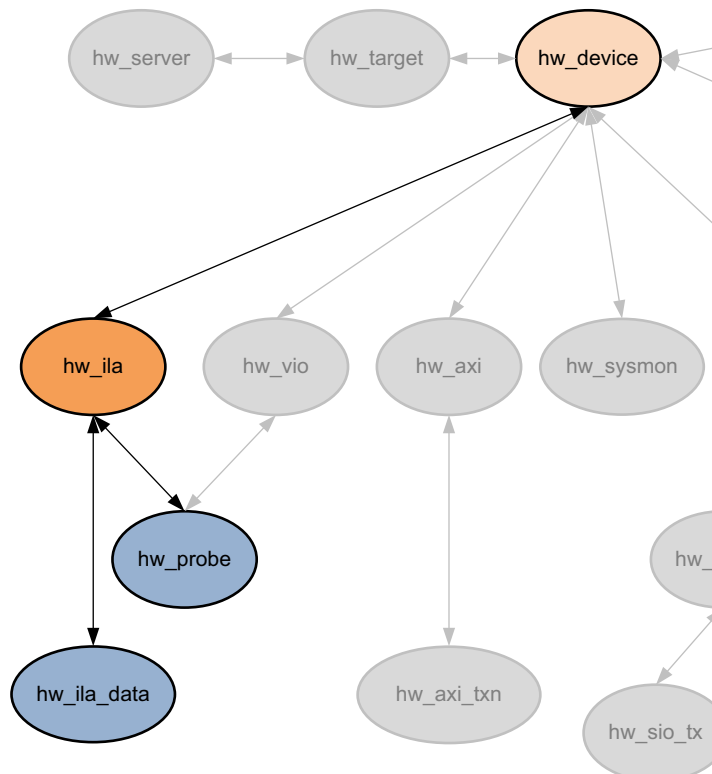

Figure 2-19: Hardware ILA Objects

ILA debug cores can be added to a design in the RTL source files, or using the `create_debug_core` Tcl command. Debug cores can be found in the synthesized netlist design using the `get_debug_cores` command. These are not the hardware ILA debug core objects, `hw_ila`, found in the Hardware Manager feature of the Vivado Design Suite, though they are related.

The hardware ILA debug core can be found in the Hardware Manager on the programmed hardware device object, `hw_device`. You can query the `hw_ila` of the `hw_device` as follows:

```
get_hw_ilas -of [current_hw_device]
```

There are also objects associated with the hardware ILA debug core, such as hardware probes, and the captured data samples from the `hw_ila` core. You can query the objects associated with the ILA debug cores as follows:

```
get_hw_ila_datas -of_objects [get_hw_ilas hw_ila_2]
```

Properties

You can use the `report_property` command to report the actual properties assigned to a specific `HW_ILA`. Refer to the *Vivado Design Suite Tcl Command Reference Guide* (UG835) [Ref 13] for more information.

The properties assigned to `HW_ILA` objects include the following:

Property	Type	Read-only	Visible	Value
CLASS	string	true	true	hw_ila
CONTROL.CAPTURE_CONDITION	enum	false	true	AND
CONTROL.CAPTURE_MODE	enum	false	true	ALWAYS
CONTROL.DATA_DEPTH	int	false	true	1024
CONTROL.IS_ILA_TO_DRIVE_TRIG_OUT_ENABLED	bool	true	true	0
CONTROL.IS_TRIG_IN_TO_DRIVE_TRIG_OUT_ENABLED	bool	true	true	0
CONTROL.IS_TRIG_IN_TO_ILA_ENABLED	bool	true	true	0
CONTROL.TRIGGER_CONDITION	string	false	true	AND
CONTROL.TRIGGER_MODE	enum	false	true	BASIC_ONLY
CONTROL.TRIGGER_POSITION	int	false	true	0
CONTROL.TRIG_OUT_MODE	enum	true	true	DISABLED
CONTROL.TSM_FILE	string	false	true	
CONTROL.WINDOW_COUNT	int	false	true	1
CORE_REFRESH_RATE_MS	int	false	true	500
HW_CORE	string	true	false	core_1
INSTANCE_NAME	string	true	true	u_ila_0
NAME	string	true	true	hw_ila_1
STATIC.IS_ADVANCED_TRIGGER_MODE_SUPPORTED	bool	true	true	1
STATIC.IS_BASIC_CAPTURE_MODE_SUPPORTED	bool	true	true	1
STATIC.IS_TRIG_IN_SUPPORTED	bool	true	true	0
STATIC.IS_TRIG_OUT_SUPPORTED	bool	true	true	0
STATIC.MAX_DATA_DEPTH	int	true	true	1024
STATIC.TSM_COUNTER_0_WIDTH	int	true	true	15
STATIC.TSM_COUNTER_1_WIDTH	int	true	true	15
STATIC.TSM_COUNTER_2_WIDTH	int	true	true	15
STATIC.TSM_COUNTER_3_WIDTH	int	true	true	15
STATUS.CORE_STATUS	string	true	true	IDLE
STATUS.DATA_DEPTH	int	true	true	2147483647

STATUS.IS_TRIGGER_AT_STARTUP	bool	true	true	0
STATUS.SAMPLE_COUNT	int	true	true	0
STATUS.TRIGGER_POSITION	int	true	true	2147483647
STATUS.TSM_FLAG0	bool	true	true	1
STATUS.TSM_FLAG1	bool	true	true	1
STATUS.TSM_FLAG2	bool	true	true	1
STATUS.TSM_FLAG3	bool	true	true	1
STATUS.TSM_STATE	int	true	true	0
STATUS.WINDOW_COUNT	int	true	true	2147483647
TRIGGER_START_TIME_SECONDS	string	true	true	
TRIGGER_STOP_TIME_SECONDS	string	true	true	

To report the properties for a specific HW_ILA, you can copy and paste the following command into the Vivado Design Suite Tcl shell or Tcl console:

```
report_property -all [lindex [get_hw_ilas] 0]
```

HW_ILA_DATA

Description

The hardware ILA data object is a repository for data captured on the ILA debug core programmed onto the current hardware device. The `upload_hw_ila_data` command creates a `hw_ila_data` object in the process of moving the captured data from the ILA debug core, `hw_ila`, on the physical FPGA, `hw_device`.

The `read_hw_ila_data` command can also create a `hw_ila_data` object when reading an ILA data file from disk.

The `hw_ila_data` object can be viewed in the waveform viewer of the Vivado logic analyzer by using the `display_hw_ila_data` command, and can be written to disk using the `write_hw_ila_data` command.

Related Objects

As seen in [Figure 2-19, page 62](#), the hardware ILA data objects are associated with the ILA debug cores programmed on the hardware device. You can query the data objects as follows:

```
get_hw_ila_datas -of_objects [get_hw_ilas]
```

Properties

You can use the `report_property` command to report the properties assigned to a `hw_ila_data` object. Refer to the *Vivado Design Suite Tcl Command Reference Guide* (UG835) [\[Ref 13\]](#) for more information. The properties are as follows:

Property	Type	Read-only	Visible	Value
CLASS	string	true	true	hw_ila_data
HW_ILA	string	true	true	hw_ila_1
NAME	string	true	true	hw_ila_data_1
TIMESTAMP	string	true	true	Sat Mar 08 11:05:49 2014

To report the properties for the `hw_ila_data` object, you can copy and paste the following command into the Vivado Design Suite Tcl shell or Tcl console:

```
report_property -all [lindex [get_hw_ila_datas] 0]
```

HW_PROBE

Description

A hardware probe object, `hw_probe`, provides access to signals in the design to monitor and drive signal values, and track hardware events on the FPGA. Hardware probes can be added to both ILA and VIO debug cores.

Debug probes can be added to ILA debug cores in the RTL design source, along with the core, or in the synthesized netlist design using the `create_debug_probe` command, and connected to signals in the design using `connect_debug_probe`.

Probes can only be added to VIO debug cores in the RTL design when the IP core is customized, or re-customized, from the IP catalog, and signals connected to it. Refer to the *Vivado Design Suite User Guide: Programming and Debugging* (UG908) [Ref 23] for more information on adding ILA and VIO debug cores and signal probes to the design.

Debug cores and probes are written to a probes file (.ltx) with `write_debug_probes`, and associated with the hardware device, along with the bitstream file (.bit), using the `PROBES.FILE` and `PROGRAM.FILE` properties of the `hw_device` object. The hardware device is programmed with this information using the `program_hw_device` command.

Related Objects

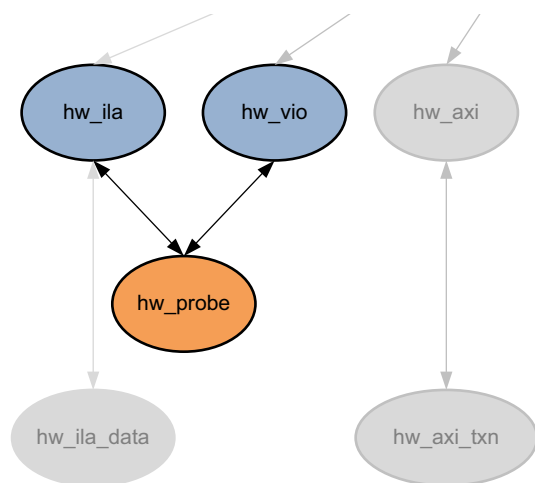

Figure 2-20: Hardware Probe Objects

The hardware probe objects are associated with the ILA and VIO debug cores programmed onto the hardware devices on the `hw_target` opened through the `hw_server`. You can query the `hw_probe` objects associated with these debug core objects:

```
get_hw_probes -of [get_hw_ilas hw_ila_2]
get_hw_probes -of [get_hw_vios]
```

Properties

There are three types of debug probes: ILA, VIO_INPUT, and VIO_OUTPUT. The properties assigned to a hw_probe object depend on the type of probe. You can use the `report_property` command to report the properties assigned to a hw_probe object. Refer to the *Vivado Design Suite Tcl Command Reference Guide* (UG835) [Ref 13] for more information. The properties assigned to an ILA type hw_probe object includes the following, with example values:

Property	Type	Read-only	Visible	Value
CAPTURE_COMPARE_VALUE	string	false	true	eq2'hX
CLASS	string	true	true	hw_probe
COMPARATOR_COUNT	int	true	true	4
COMPARE_VALUE.0	string	false	false	eq2'hX
CORE_LOCATION	string	true	false	1:0
DISPLAY_HINT	string	false	false	
DISPLAY_VISIBILITY	string	false	false	
HW_ILA	string	true	true	hw_ila_1
NAME	string	true	true	GPIO_BUTTONS_dly
PROBE_PORT	int	true	true	3
PROBE_PORT_BITS	int	true	true	0
PROBE_PORT_BIT_COUNT	int	true	true	2
TRIGGER_COMPARE_VALUE	string	false	true	eq2'hX
TYPE	string	true	true	ila

To report the properties for a specific type of hw_probe object, you can copy and paste one of the following commands into the Vivado Design Suite Tcl shell or Tcl console:

```
report_property -all [lindex [get_hw_probes -filter {TYPE == ila}] 0]
report_property -all [lindex [get_hw_probes -filter {TYPE == vio_input}] 0]
report_property -all [lindex [get_hw_probes -filter {TYPE == vio_output}] 0]
```

HW_SERVER

Description

The hardware server manages connections to a hardware target, for instance a hardware board containing a JTAG chain of one or more Xilinx FPGA devices to be used for programming and debugging your FPGA design.

When you open the Hardware Manager with the `open_hw` command, you can connect to a hardware server, either locally or remotely, using the `connect_hw_server` command. This launches the `hw_server` application, and creates a `hw_server` object.

Related Objects

As seen in [Figure 1-3, page 15](#), hardware servers are apex objects in the Hardware Manager, managing connections to hardware targets. You can query the objects related to the `hw_server`:

```
get_hw_targets -of [get_hw_servers]
```

Properties

You can use the `report_property` command to report the properties assigned to a `hw_server` object. Refer to the *Vivado Design Suite Tcl Command Reference Guide* (UG835) [\[Ref 13\]](#) for more information. The properties assigned to the `hw_target` object include the following, with example values:

Property	Type	Read-only	Visible	Value
CLASS	string	true	true	hw_server
HOST	string	true	true	localhost
NAME	string	true	true	localhost
PASSWORD	string	true	true	
PORT	string	true	true	60001
SID	string	true	true	TCP:xcoatslab-1:3121
VERSION	string	true	true	20

To report the properties for a `hw_target`, you can copy and paste the following command into the Vivado Design Suite Tcl shell or Tcl console:

```
report_property -all [get_hw_servers]
```

HW_SIO_GT

Description

The customizable LogiCORE™ IP Integrated Bit Error Ratio Tester (IBERT) core for Xilinx FPGAs is designed for evaluating and monitoring the Gigabit Transceivers (GTs). The IBERT core enables in-system serial I/O validation and debug, letting you measure and optimize the high-speed serial I/O links in your design. Refer to the *Integrated Bit Error Ratio Tester 7 Series GTX Transceivers LogiCORE IP Product Guide* (PG132) [Ref 30] for more information.

Using the IBERT debug core you can configure and tune the GT transmitters and receivers through the Dynamic Reconfiguration Port (DRP) port of the GTX transceiver. This lets you change property settings on the GTs, as well as registers that control the values on the ports.

Related Objects

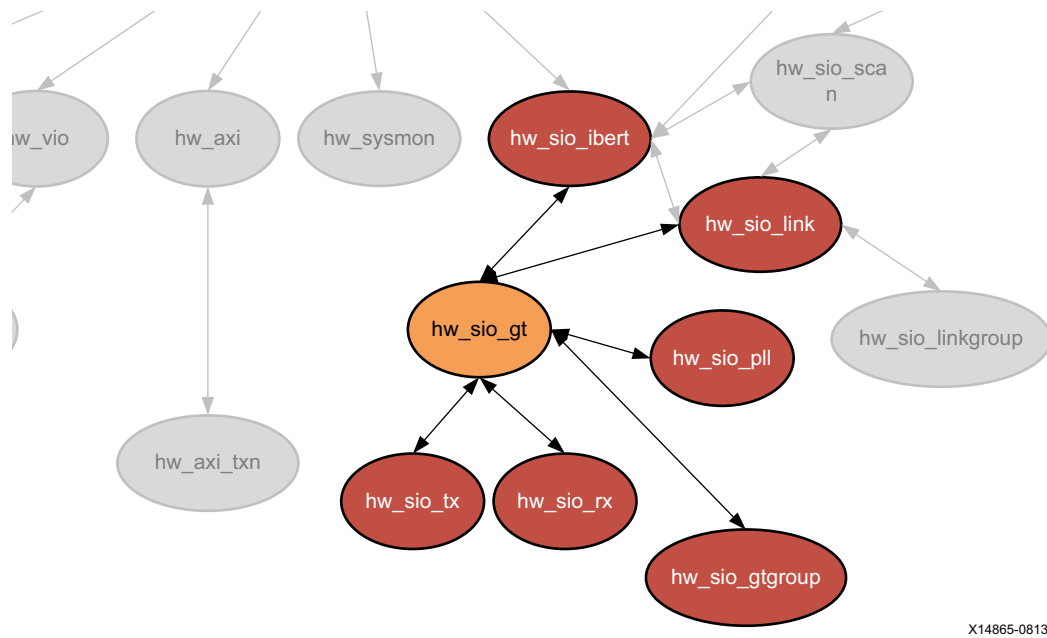

X14865-081315

Figure 2-21: Hardware SIO GT Objects

HW_SIO_GT objects are associated with hw_server, hw_target, hw_device, hw_sio_gt, hw_sio_common, hw_sio_pll, hw_sio_tx, hw_sio_rx, or hw_sio_link objects. You can query the GT objects associated with these objects:

```
get_hw_sio_gts -of_objects [get_hw_sio_links]
```

You can also query the objects associated with hw_sio_gt objects:

```
get_hw_sio_gtgroups -of [get_hw_sio_gts *MGT_X0Y9]
```

Properties

You can use the `report_property` command to report the actual properties assigned to a specific HW_SIO_GT. Refer to the *Vivado Design Suite Tcl Command Reference Guide* (UG835) [Ref 13] for more information.

The properties assigned to HW_SIO_GT objects include the following:

Property	Type	Read-only	Visible	Value
CLASS	string	true	true	hw_sio_gt
CPLLREFCLKSEL	enum	false	true	GTREFCLK0
CPLL_FBDIV	enum	false	true	1
CPLL_FBDIV_45	enum	false	true	4
CPLL_REFCLK_DIV	enum	false	true	1
DISPLAY_NAME	string	true	true	MGT_X0Y8
DRP.ALIGN_COMMA_DOUBLE	string	false	true	0
DRP.ALIGN_COMMA_ENABLE	string	false	true	07F
DRP.ALIGN_COMMA_WORD	string	false	true	1
DRP.ALIGN_MCOMMA_DET	string	false	true	1
DRP.ALIGN_MCOMMA_VALUE	string	false	true	283
DRP.ALIGN_PCOMMA_DET	string	false	true	1
DRP.ALIGN_PCOMMA_VALUE	string	false	true	17C
DRP.CBCC_DATA_SOURCE_SEL	string	false	true	1
DRP.CHAN_BOND_KEEP_ALIGN	string	false	true	0
DRP.CHAN_BOND_MAX_SKEW	string	false	true	7
DRP.CHAN_BOND_SEQ_1_1	string	false	true	17C
DRP.CHAN_BOND_SEQ_1_2	string	false	true	100
DRP.CHAN_BOND_SEQ_1_3	string	false	true	100
DRP.CHAN_BOND_SEQ_1_4	string	false	true	100
DRP.CHAN_BOND_SEQ_1_ENABLE	string	false	true	F
DRP.CHAN_BOND_SEQ_2_1	string	false	true	100
DRP.CHAN_BOND_SEQ_2_2	string	false	true	100
DRP.CHAN_BOND_SEQ_2_3	string	false	true	100
DRP.CHAN_BOND_SEQ_2_4	string	false	true	100
DRP.CHAN_BOND_SEQ_2_ENABLE	string	false	true	F
DRP.CHAN_BOND_SEQ_2_USE	string	false	true	0
DRP.CHAN_BOND_SEQ_LEN	string	false	true	0
DRP.CLK_CORRECT_USE	string	false	true	0
DRP.CLK_COR_KEEP_IDLE	string	false	true	0
DRP.CLK_COR_MAX_LAT	string	false	true	13
DRP.CLK_COR_MIN_LAT	string	false	true	0F
DRP.CLK_COR_PRECEDENCE	string	false	true	1
DRP.CLK_COR_REPEAT_WAIT	string	false	true	00
DRP.CLK_COR_SEQ_1_1	string	false	true	11C
DRP.CLK_COR_SEQ_1_2	string	false	true	100
DRP.CLK_COR_SEQ_1_3	string	false	true	100
DRP.CLK_COR_SEQ_1_4	string	false	true	100
DRP.CLK_COR_SEQ_1_ENABLE	string	false	true	F
DRP.CLK_COR_SEQ_2_1	string	false	true	100
DRP.CLK_COR_SEQ_2_2	string	false	true	100
DRP.CLK_COR_SEQ_2_3	string	false	true	100
DRP.CLK_COR_SEQ_2_4	string	false	true	100
DRP.CLK_COR_SEQ_2_ENABLE	string	false	true	F
DRP.CLK_COR_SEQ_2_USE	string	false	true	0
DRP.CLK_COR_SEQ_LEN	string	false	true	0
DRP.CPLL_CFG	string	false	true	BC07DC
DRP.CPLL_FBDIV	string	false	true	10

DRP.CPLL_FBDIV_45	string	false	true	0
DRP.CPLL_INIT_CFG	string	false	true	00001E
DRP.CPLL_LOCK_CFG	string	false	true	01C0
DRP.CPLL_REFCLK_DIV	string	false	true	10
DRP.DEC_MCOMMA_DETECT	string	false	true	0
DRP.DEC_PCOMMA_DETECT	string	false	true	0
DRP.DEC_VALID_COMMA_ONLY	string	false	true	0
DRP.DMONITOR_CFG	string	false	true	000A01
DRP.ES_CONTROL	string	false	true	00
DRP.ES_CONTROL_STATUS	string	false	true	0
DRP.ES_ERRDET_EN	string	false	true	0
DRP.ES_ERROR_COUNT	string	false	true	0000
DRP.ES_EYE_SCAN_EN	string	false	true	1
DRP.ES_HORZ_OFFSET	string	false	true	000
DRP.ES_PMA_CFG	string	false	true	000
DRP.ES_PRESCALE	string	false	true	00
DRP.ES_QUALIFIER	string	false	true	00000000000000000000
DRP.ES_QUAL_MASK	string	false	true	00000000000000000000
DRP.ES_RDATA	string	false	true	00000000000000000000
DRP.ES_SAMPLE_COUNT	string	false	true	0000
DRP.ES_SDATA	string	false	true	00000000000000000000
DRP.ES_SDATA_MASK	string	false	true	00000000000000000000
DRP.ES_UT_SIGN	string	false	true	0
DRP.ES_VERT_OFFSET	string	false	true	000
DRP.FTS_DESKEW_SEQ_ENABLE	string	false	true	F
DRP.FTS_LANE_DESKEW_CFG	string	false	true	F
DRP.FTS_LANE_DESKEW_EN	string	false	true	0
DRP.GEARBOX_MODE	string	false	true	0
DRP.OUTREFCLK_SEL_INV	string	false	true	3
DRP.PCS_PCIE_EN	string	false	true	0
DRP.PCS_RSVD_ATTR	string	false	true	000000000000
DRP.PD_TRANS_TIME_FROM_P2	string	false	true	03C
DRP.PD_TRANS_TIME_NONE_P2	string	false	true	3C
DRP.PD_TRANS_TIME_TO_P2	string	false	true	64
DRP.PMA_RSV	string	false	true	001E7080
DRP.PMA_RSV2	string	false	true	2070
DRP.PMA_RSV2_BIT4	string	false	true	1
DRP.PMA_RSV3	string	false	true	0
DRP.PMA_RSV4	string	false	true	00000000
DRP.RXBUFRESET_TIME	string	false	true	01
DRP.RXBUF_ADDR_MODE	string	false	true	1
DRP.RXBUF_EIDLE_HI_CNT	string	false	true	8
DRP.RXBUF_EIDLE_LO_CNT	string	false	true	0
DRP.RXBUF_EN	string	false	true	1
DRP.RXBUF_RESET_ON_CB_CHANGE	string	false	true	1
DRP.RXBUF_RESET_ON_COMMAALIGN	string	false	true	0
DRP.RXBUF_RESET_ON_EIDLE	string	false	true	0
DRP.RXBUF_RESET_ON_RATE_CHANGE	string	false	true	1
DRP.RXBUF_THRESH_OVFLW	string	false	true	3D
DRP.RXBUF_THRESH_OVRD	string	false	true	0
DRP.RXBUF_THRESH_UNDFLW	string	false	true	04
DRP.RXCDRFREQRESET_TIME	string	false	true	01
DRP.RXCDRPHRESET_TIME	string	false	true	01
DRP.RXCDR_CFG	string	false	true	0B800023FF10200020
DRP.RXCDR_FR_RESET_ON_EIDLE	string	false	true	0
DRP.RXCDR_HOLD_DURING_EIDLE	string	false	true	0
DRP.RXCDR_LOCK_CFG	string	false	true	15
DRP.RXCDR_PH_RESET_ON_EIDLE	string	false	true	0
DRP.RXDFELPMRESET_TIME	string	false	true	0F

DRP.RXDLY_CFG	string	false	true	001F
DRP.RXDLY_LCFG	string	false	true	030
DRP.RXDLY_TAP_CFG	string	false	true	0000
DRP.RXGEARBOX_EN	string	false	true	0
DRP.RXISCANRESET_TIME	string	false	true	01
DRP.RXLPM_HF_CFG	string	false	true	00F0
DRP.RXLPM_LF_CFG	string	false	true	00F0
DRP.RXOOB_CFG	string	false	true	06
DRP.RXOUT_DIV	string	false	true	0
DRP.RXPCSRESET_TIME	string	false	true	01
DRP.RXPHDLY_CFG	string	false	true	084020
DRP.RXPH_CFG	string	false	true	000000
DRP.RXPH_MONITOR_SEL	string	false	true	00
DRP.RXPMARESET_TIME	string	false	true	03
DRP.RXPRBS_ERR_LOOPBACK	string	false	true	0
DRP.RXSLIDE_AUTO_WAIT	string	false	true	7
DRP.RXSLIDE_MODE	string	false	true	0
DRP.RX_BIAS_CFG	string	false	true	004
DRP.RX_BUFFER_CFG	string	false	true	00
DRP.RX_CLK25_DIV	string	false	true	04
DRP.RX_CLKMUX_PD	string	false	true	1
DRP.RX_CM_SEL	string	false	true	3
DRP.RX_CM_TRIM	string	false	true	4
DRP.RX_DATA_WIDTH	string	false	true	5
DRP.RX_DDI_SEL	string	false	true	00
DRP.RX_DEBUG_CFG	string	false	true	000
DRP.RX_DEFER_RESET_BUF_EN	string	false	true	1
DRP.RX_DFE_CTLE_STAGE1	string	false	true	8
DRP.RX_DFE_CTLE_STAGE2	string	false	true	3
DRP.RX_DFE_CTLE_STAGE3	string	false	true	0
DRP.RX_DFE_GAIN_CFG	string	false	true	020FEA
DRP.RX_DFE_H2_CFG	string	false	true	000
DRP.RX_DFE_H3_CFG	string	false	true	040
DRP.RX_DFE_H4_CFG	string	false	true	0F0
DRP.RX_DFE_H5_CFG	string	false	true	0E0
DRP.RX_DFE_KL_CFG	string	false	true	00FE
DRP.RX_DFE_KL_CFG2	string	false	true	3010D90C
DRP.RX_DFE_LPM_CFG	string	false	true	0954
DRP.RX_DFE_LPM_HOLD_DURING_EIDLE	string	false	true	0
DRP.RX_DFE_UT_CFG	string	false	true	11E00
DRP.RX_DFE_VP_CFG	string	false	true	03F03
DRP.RX_DFE_XYD_CFG	string	false	true	0000
DRP.RX_DISPERR_SEQ_MATCH	string	false	true	1
DRP.RX_INT_DATAWIDTH	string	false	true	1
DRP.RX_OS_CFG	string	false	true	0080
DRP.RX_SIG_VALID_DLY	string	false	true	09
DRP.RX_XCLK_SEL	string	false	true	0
DRP.SAS_MAX_COM	string	false	true	40
DRP.SAS_MIN_COM	string	false	true	24
DRP.SATA_BURST_SEQ_LEN	string	false	true	F
DRP.SATA_BURST_VAL	string	false	true	4
DRP.SATA_CPLL_CFG	string	false	true	0
DRP.SATA_EIDLE_VAL	string	false	true	4
DRP.SATA_MAX_BURST	string	false	true	08
DRP.SATA_MAX_INIT	string	false	true	15
DRP.SATA_MAX_WAKE	string	false	true	07
DRP.SATA_MIN_BURST	string	false	true	04
DRP.SATA_MIN_INIT	string	false	true	0C
DRP.SATA_MIN_WAKE	string	false	true	04

DRP.SHOW_REALIGN_COMMA	string	false	true	1
DRP.TERM_RCAL_CFG	string	false	true	10
DRP.TERM_RCAL_OVRD	string	false	true	0
DRP.TRANS_TIME_RATE	string	false	true	0E
DRP.TST_RSV	string	false	true	00000000
DRP.TXBUF_EN	string	false	true	1
DRP.TXBUF_RESET_ON_RATE_CHANGE	string	false	true	0
DRP.TXDLY_CFG	string	false	true	001F
DRP.TXDLY_LCFG	string	false	true	030
DRP.TXDLY_TAP_CFG	string	false	true	0000
DRP.TXGEARBOX_EN	string	false	true	0
DRP.TXOUT_DIV	string	false	true	0
DRP.TXPCSRESET_TIME	string	false	true	01
DRP.TXPHDLY_CFG	string	false	true	084020
DRP.TXPH_CFG	string	false	true	0780
DRP.TXPH_MONITOR_SEL	string	false	true	00
DRP.TXPMARESET_TIME	string	false	true	01
DRP.TX_CLK25_DIV	string	false	true	04
DRP.TX_CLKMUX_PD	string	false	true	1
DRP.TX_DATA_WIDTH	string	false	true	5
DRP.TX_DEEMPH0	string	false	true	00
DRP.TX_DEEMPH1	string	false	true	00
DRP.TX_DRIVE_MODE	string	false	true	00
DRP.TX_IDLE_ASSERT_DELAY	string	false	true	6
DRP.TX_IDLE_DEASSERT_DELAY	string	false	true	4
DRP.TX_INT_DATAWIDTH	string	false	true	1
DRP.TX_LOOPBACK_DRIVE_HIZ	string	false	true	0
DRP.TX_MAINCURSOR_SEL	string	false	true	0
DRP.TX_MARGIN_FULL_0	string	false	true	4E
DRP.TX_MARGIN_FULL_1	string	false	true	49
DRP.TX_MARGIN_FULL_2	string	false	true	45
DRP.TX_MARGIN_FULL_3	string	false	true	42
DRP.TX_MARGIN_FULL_4	string	false	true	40
DRP.TX_MARGIN_LOW_0	string	false	true	46
DRP.TX_MARGIN_LOW_1	string	false	true	44
DRP.TX_MARGIN_LOW_2	string	false	true	42
DRP.TX_MARGIN_LOW_3	string	false	true	40
DRP.TX_MARGIN_LOW_4	string	false	true	40
DRP.TX_PREDRIVER_MODE	string	false	true	0
DRP.TX_QPI_STATUS_EN	string	false	true	0
DRP.TX_RXDETECT_CFG	string	false	true	1832
DRP.TX_RXDETECT_REF	string	false	true	4
DRP.TX_XCLK_SEL	string	false	true	0
DRP.UCODEER_CLR	string	false	true	0
ES_HORZ_MIN_MAX	string	false	true	32
GT_TYPE	string	true	true	7 Series GTX
LINE_RATE	string	false	true	0.000
LOGIC.DEBUG_CLOCKS	string	false	true	0
LOGIC.ERRBIT_COUNT	string	false	true	000000000000
LOGIC.ERR_INJECT_CTRL	string	false	true	0
LOGIC.FRAME_LEN	string	false	true	0000
LOGIC.GT_SOURCES_SYSCLK	string	false	true	0
LOGIC.IDLE_DETECTED	string	false	true	0
LOGIC.IFG_LEN	string	false	true	00
LOGIC.LINK	string	false	true	0
LOGIC.MAX_LINERATE	string	false	true	0001DCD65000
LOGIC.MAX_REFCLK_FREQ	string	false	true	07735940
LOGIC.MGT_COORDINATE	string	false	true	0008
LOGIC.MGT_ERRCNT_RESET_CTRL	string	false	true	0

LOGIC.MGT_ERRCNT_RESET_STAT	string	false	true	0
LOGIC.MGT_NUMBER	string	false	true	0075
LOGIC.MGT_RESET_CTRL	string	false	true	0
LOGIC.MGT_RESET_STAT	string	false	true	0
LOGIC.PROTOCOL_ENUM	string	false	true	0000
LOGIC.RXPAT_ID	string	false	true	1
LOGIC.RXRECCLK_FREQ_CNT	string	false	true	0000
LOGIC.RXRECCLK_FREQ_TUNE	string	false	true	4000
LOGIC.RXUSRCLK2_FREQ_CNT	string	false	true	0000
LOGIC.RXUSRCLK2_FREQ_TUNE	string	false	true	4000
LOGIC.RXUSRCLK_FREQ_CNT	string	false	true	0000
LOGIC.RXUSRCLK_FREQ_TUNE	string	false	true	4000
LOGIC.RXWORD_COUNT	string	false	true	000000000000
LOGIC.RX_DCM_LOCK	string	false	true	1
LOGIC.RX_DCM_RESET_CTRL	string	false	true	0
LOGIC.RX_DCM_RESET_STAT	string	false	true	0
LOGIC.RX_FRAMED	string	false	true	0
LOGIC.SILICON_VERSION	string	false	true	0300
LOGIC.TIMER	string	false	true	009736E7B9BC
LOGIC.TXOUTCLK_FREQ_CNT	string	false	true	0000
LOGIC.TXOUTCLK_FREQ_TUNE	string	false	true	4000
LOGIC.TXPAT_ID	string	false	true	1
LOGIC.TXUSRCLK2_FREQ_CNT	string	false	true	0000
LOGIC.TXUSRCLK2_FREQ_TUNE	string	false	true	4000
LOGIC.TXUSRCLK_FREQ_CNT	string	false	true	0000
LOGIC.TXUSRCLK_FREQ_TUNE	string	false	true	4000
LOGIC.TX_DCM_LOCK	string	false	true	1
LOGIC.TX_DCM_RESET_CTRL	string	false	true	0
LOGIC.TX_DCM_RESET_STAT	string	false	true	1
LOGIC.TX_FRAMED	string	false	true	0
LOOPBACK	enum	false	true	None
NAME	string	true	true	
localhost/xilinx_tcf/Digilent/210203327463A/0_1/IBERT/Quad_117/MGT_X0Y8				
PARENT	string	true	true	
localhost/xilinx_tcf/Digilent/210203327463A/0_1/IBERT				
PLL_STATUS	string	false	true	LOCKED
PORT.CFGRESET	string	false	true	0
PORT.CLKRSVD	string	false	true	0
PORT.CPLLFBCLKLOST	string	false	true	0
PORT.CPLLLOCK	string	false	true	1
PORT.CPLLLOCKDETCCLK	string	false	true	0
PORT.CPLLLOCKEN	string	false	true	1
PORT.CPLLPD	string	false	true	0
PORT.CPLLREFCLKLOST	string	false	true	0
PORT.CPLLREFCLKSEL	string	false	true	1
PORT.CPLLRESET	string	false	true	0
PORT.DMONITOROUT	string	false	true	1F
PORT.EYESCANDATAERROR	string	false	true	0
PORT.EYESCANMODE	string	false	true	0
PORT.EYESCANRESET	string	false	true	0
PORT.EYESCANTRIGGER	string	false	true	0
PORT.GTREFCLKMONITOR	string	false	true	1
PORT.GTRESETSEL	string	false	true	0
PORT.GTRSVD	string	false	true	0000
PORT.GTRXRESET	string	false	true	0
PORT.GTTXRESET	string	false	true	0
PORT.LOOPBACK	string	false	true	0
PORT.PCSRSVDIN	string	false	true	0000
PORT.PCSRSVDIN2	string	false	true	00

PORT.PCSRSVDOUT	string	false	true	01F3
PORT.PHYSTATUS	string	false	true	1
PORT.PMARSVDIN	string	false	true	00
PORT.PMARSVDIN2	string	false	true	00
PORT.RESETOVRD	string	false	true	0
PORT.RX8B10BEN	string	false	true	0
PORT.RXBUFRESET	string	false	true	0
PORT.RXBUFSTATUS	string	false	true	0
PORT.RXBYTEISALIGNED	string	false	true	0
PORT.RXBYTEREALIGN	string	false	true	0
PORT.RXCDRFREQRESET	string	false	true	0
PORT.RXCDRHOLD	string	false	true	0
PORT.RXCDRLOCK	string	false	true	0
PORT.RXCDROVRDEN	string	false	true	0
PORT.RXCDRRESET	string	false	true	0
PORT.RXCDRRESETRSV	string	false	true	0
PORT.RXCHANBONDSEQ	string	false	true	0
PORT.RXCHANISALIGNED	string	false	true	0
PORT.RXCHANREALIGN	string	false	true	0
PORT.RXCHARISCOMMA	string	false	true	00
PORT.RXCHARISK	string	false	true	00
PORT.RXCHBONDEN	string	false	true	0
PORT.RXCHBONDI	string	false	true	10
PORT.RXCHBONDLEVEL	string	false	true	0
PORT.RXCHBONDMASTER	string	false	true	0
PORT.RXCHBONDO	string	false	true	00
PORT.RXCHBONDSLAVE	string	false	true	0
PORT.RXCLKCORCNT	string	false	true	0
PORT.RXCOMINITDET	string	false	true	0
PORT.RXCOMMADET	string	false	true	0
PORT.RXCOMMADETEN	string	false	true	0
PORT.RXCOMSASDET	string	false	true	0
PORT.RXCOMWAKEDET	string	false	true	0
PORT.RXDATAVALID	string	false	true	0
PORT.RXDDIEN	string	false	true	0
PORT.RXDFEAGCHOLD	string	false	true	0
PORT.RXDFEAGCOVRDEN	string	false	true	0
PORT.RXDFECM1EN	string	false	true	0
PORT.RXDFELFHOLD	string	false	true	0
PORT.RXDFELFOVRDEN	string	false	true	0
PORT.RXDFELPMRESET	string	false	true	0
PORT.RXDFETAP2HOLD	string	false	true	0
PORT.RXDFETAP2OVRDEN	string	false	true	0
PORT.RXDFETAP3HOLD	string	false	true	0
PORT.RXDFETAP3OVRDEN	string	false	true	0
PORT.RXDFETAP4HOLD	string	false	true	0
PORT.RXDFETAP4OVRDEN	string	false	true	0
PORT.RXDFETAP5HOLD	string	false	true	0
PORT.RXDFETAP5OVRDEN	string	false	true	0
PORT.RXDFEUTHOLD	string	false	true	0
PORT.RXDFEUTOVRDEN	string	false	true	0
PORT.RXDFEVPHOLD	string	false	true	0
PORT.RXDFEVPOVRDEN	string	false	true	0
PORT.RXDFEVSEN	string	false	true	0
PORT.RXDFEXYDEN	string	false	true	0
PORT.RXDFEXYDHOLD	string	false	true	0
PORT.RXDFEXYDOVRDEN	string	false	true	0
PORT.RXDISPERR	string	false	true	00
PORT.RXDLYBYPASS	string	false	true	1

PORT.RXDLYEN	string	false	true	0
PORT.RXDLYOVRDEN	string	false	true	0
PORT.RXDLYSRESET	string	false	true	0
PORT.RXDLYSRESETDONE	string	false	true	0
PORT.RXELECIDLE	string	false	true	1
PORT.RXELECIDLEMODE	string	false	true	0
PORT.RXGEARBOXSLIP	string	false	true	0
PORT.RXHEADER	string	false	true	0
PORT.RXHEADERVALID	string	false	true	0
PORT.RXLPMEN	string	false	true	0
PORT.RXLPMHFHOLD	string	false	true	0
PORT.RXLPMHFVRDEN	string	false	true	0
PORT.RXLPLMFHOLD	string	false	true	0
PORT.RXLPLMFKLOVRDEN	string	false	true	0
PORT.RXMCOMMAALIGNEN	string	false	true	0
PORT.RXMONITOROUT	string	false	true	7F
PORT.RXMONITORSEL	string	false	true	0
PORT.RXNOTINTABLE	string	false	true	FF
PORT.RXOBRRESET	string	false	true	0
PORT.RXOSHOLD	string	false	true	0
PORT.RXOSOVRDEN	string	false	true	0
PORT.RXOUTCLKFABRIC	string	false	true	0
PORT.RXOUTCLKPCS	string	false	true	0
PORT.RXOUTCLKSEL	string	false	true	1
PORT.RXPCOMMAALIGNEN	string	false	true	0
PORT.RXPCSRESET	string	false	true	0
PORT.RXPD	string	false	true	0
PORT.RXPHALIGN	string	false	true	0
PORT.RXPHALIGNDONE	string	false	true	0
PORT.RXPHALIGNEN	string	false	true	0
PORT.RXPHDLYPD	string	false	true	0
PORT.RXPHDLYRESET	string	false	true	0
PORT.RXPHMONITOR	string	false	true	00
PORT.RXPHOVRDEN	string	false	true	0
PORT.RXPHSLIPMONITOR	string	false	true	04
PORT.RXPMARESET	string	false	true	0
PORT.RXPOLARITY	string	false	true	0
PORT.RXPRBSCNTRESET	string	false	true	0
PORT.RXPRBSERR	string	false	true	0
PORT.RXPRBSSEL	string	false	true	0
PORT.RXQPIEN	string	false	true	0
PORT.RXQPISENN	string	false	true	0
PORT.RXQPISENP	string	false	true	0
PORT.RXRATE	string	false	true	0
PORT.RXRATEDONE	string	false	true	0
PORT.RXRESETDONE	string	false	true	0
PORT.RXSLIDE	string	false	true	0
PORT.RXSTARTOFSEQ	string	false	true	0
PORT.RXSTATUS	string	false	true	0
PORT.RXSYSCLKSEL	string	false	true	3
PORT.RXUSERRDY	string	false	true	1
PORT.RXVALID	string	false	true	0
PORT.SETERRSTATUS	string	false	true	0
PORT.TSTIN	string	false	true	FFFF
PORT.TSTOUT	string	false	true	000
PORT.TX8B10BBYPASS	string	false	true	FF
PORT.TX8B10BEN	string	false	true	0
PORT.TXBUFDIFFCTRL	string	false	true	4
PORT.TXBUFSTATUS	string	false	true	0

PORT.TXCHARDISPMODE	string	false	true	00
PORT.TXCHARDISPVAL	string	false	true	00
PORT.TXCHARISK	string	false	true	00
PORT.TXCOMFINISH	string	false	true	0
PORT.TXCOMINIT	string	false	true	0
PORT.TXCMSAS	string	false	true	0
PORT.TXCOMWAKE	string	false	true	0
PORT.TXDEEMPH	string	false	true	0
PORT.TXDETECTRX	string	false	true	0
PORT.TXDIFFCCTRL	string	false	true	C
PORT.TXDIFFPD	string	false	true	0
PORT.TXDLYBYPASS	string	false	true	1
PORT.TXDLYEN	string	false	true	0
PORT.TXDLYHOLD	string	false	true	0
PORT.TXDLYOVRDEN	string	false	true	0
PORT.TXDLYSRESET	string	false	true	0
PORT.TXDLYSRESETDONE	string	false	true	0
PORT.TXDLYUPDOWN	string	false	true	0
PORT.TXELECIDLE	string	false	true	0
PORT.TXGEARBOXREADY	string	false	true	0
PORT.TXHEADER	string	false	true	0
PORT.TXINHIBIT	string	false	true	0
PORT.TXMAINCURSOR	string	false	true	00
PORT.TXMARGIN	string	false	true	0
PORT.TXOUTCLKFABRIC	string	false	true	1
PORT.TXOUTCLKPCS	string	false	true	0
PORT.TXOUTCLKSEL	string	false	true	2
PORT.TXPCSRESET	string	false	true	0
PORT.TXPD	string	false	true	0
PORT.TXPDELECIDLEMODE	string	false	true	0
PORT.TXPALIGN	string	false	true	0
PORT.TXPALIGNDONE	string	false	true	0
PORT.TXPALIGNEN	string	false	true	0
PORT.TXPHDLYPD	string	false	true	0
PORT.TXPHDLYRESET	string	false	true	0
PORT.TXPHDLYTSTCLK	string	false	true	0
PORT.TXPHINIT	string	false	true	0
PORT.TXPHINITDONE	string	false	true	0
PORT.TXPHOVRDEN	string	false	true	0
PORT.TXPISOPD	string	false	true	0
PORT.TXPMARESET	string	false	true	0
PORT.TXPOLARITY	string	false	true	0
PORT.TXPOSTCURSOR	string	false	true	03
PORT.TXPOSTCURSORINV	string	false	true	0
PORT.TXPRBSFORCEERR	string	false	true	0
PORT.TXPRBSSEL	string	false	true	0
PORT.TXPRECURSOR	string	false	true	07
PORT.TXPRECURSORINV	string	false	true	0
PORT.TXQPBIASEN	string	false	true	0
PORT.TXQPISENN	string	false	true	0
PORT.TXQPISENP	string	false	true	0
PORT.TXQPISTRONGPDOWN	string	false	true	0
PORT.TXQPIWEAKPUP	string	false	true	0
PORT.TXRATE	string	false	true	0
PORT.TXRATEDONE	string	false	true	0
PORT.TXRESETDONE	string	false	true	0
PORT.TXSEQUENCE	string	false	true	00
PORT.TXSTARTSEQ	string	false	true	0
PORT.TXSWING	string	false	true	0

PORT.TXSYSCLKSEL	string	false	true	3
PORT.TXUSERRDY	string	false	true	1
RXDFEENABLED	enum	false	true	1
RXOUTCLKSEL	enum	false	true	RXOUTCLKPCS
RXOUT_DIV	enum	false	true	1
RXPLL	enum	false	true	QPLL
RXRATE	enum	false	true	Use RX_OUT_DIV
RXTERM	enum	false	true	900 mV
RXTERMMODE	enum	false	true	Programmable
RXUSRCLK2_FREQ	string	false	true	0.048828
RXUSRCLK_FREQ	string	false	true	0.048828
RX_BER	string	false	true	inf
RX_DATA_WIDTH	enum	false	true	40
RX_DFE_CTLE	enum	false	true	
RX_INTERNAL_DATAPATH	enum	false	true	4-byte
RX_PATTERN	enum	false	true	PRBS 7-bit
RX_RECEIVED_BIT_COUNT	string	false	true	0
STATUS	string	false	true	NO LINK
SYSCLK_FREQ	string	false	true	100.000000
TXDIFFSWING	enum	false	true	1.018 V (1100)
TXOUTCLKSEL	enum	false	true	TXOUTCLKPMA
TXOUT_DIV	enum	false	true	1
TXPLL	enum	false	true	QPLL
TXPOST	enum	false	true	0.68 dB (00011)
TXPRE	enum	false	true	1.67 dB (00111)
TXRATE	enum	false	true	Use TXOUT_DIV
TXUSRCLK2_FREQ	string	false	true	0.048828
TXUSRCLK_FREQ	string	false	true	0.048828
TX_DATA_WIDTH	enum	false	true	40
TX_INTERNAL_DATAPATH	enum	false	true	4-byte
TX_PATTERN	enum	false	true	PRBS 7-bit

To report the properties for the HW_SIO_GT object, you can copy and paste the following command into the Vivado Design Suite Tcl shell or Tcl console:

```
report_property -all [lindex [get_hw_sio_gts] 0]
```

HW_SIO_GTGROU

Description

GT groups relate to the GT IO Banks on the hardware device, with the number of available GT pins and banks determined by the target Xilinx FPGA. On the Kintex-7 xc7k325 part, for example, there are four GT groups, each containing four differential GT pin pairs. Each GT pin has its own receiver, `hw_sio_rx`, and transmitter, `hw_sio_tx`. GT groups can also include one shared PLL per quad, or Quad PLL. The GT groups are defined on the IBERT debug core, and can be customized with a number of user settings when the IBERT is added into the RTL design. Refer to the *Integrated Bit Error Ratio Tester 7 Series GTX Transceivers LogiCORE IP Product Guide* (PG132) [Ref 30] for more information.

Related Objects

GT Groups are associated with `hw_server`, `hw_target`, `hw_device`, `hw_sio_ibert`, `hw_sio_gt`, `hw_sio_common`, `hw_sio_pll`, `hw_sio_tx`, `hw_sio_rx`, and `hw_sio_link` objects.

You can query the GT groups associated with these objects:

```
get_hw_sio_gtgroups -of [get_hw_sio_gts *MGT_X0Y9]
```

Properties

You can use the `report_property` command to report the properties of a `HW_SIO_GTGROU`. Refer to the *Vivado Design Suite Tcl Command Reference Guide* (UG835) [Ref 13] for more information. The properties on the `hw_sio_gtgroup` object include the following, with example values:

Property	Type	Read-only	Visible	Value
<code>CLASS</code>	string	true	true	<code>hw_sio_gtgroup</code>
<code>DISPLAY_NAME</code>	string	true	true	<code>Quad_117</code>
<code>GT_TYPE</code>	string	true	true	<code>7 Series GTX</code>
<code>NAME</code>	string	true	true	<code>localhost/xilinx_tcf/Digilent/210203327463A/0_1/IBERT/Quad_117</code>
<code>PARENT</code>	string	true	true	<code>localhost/xilinx_tcf/Digilent/210203327463A/0_1/IBERT</code>

To report the properties for a specific `HW_SIO_GTGROU`, you can copy and paste the following command into the Vivado Design Suite Tcl shell or Tcl console:

```
report_property -all [lindex [get_hw_sio_gtgroups] 0]
```

HW_SIO_IBERT

Description

The customizable LogiCORE™ IP Integrated Bit Error Ratio Tester (IBERT) core for Xilinx FPGAs is designed for evaluating and monitoring the Gigabit Transceivers (GTs). The IBERT core enables in-system serial I/O validation and debug, letting you measure and optimize your high-speed serial I/O links in your FPGA-based system. Refer to the *Integrated Bit Error Ratio Tester 7 Series GTX Transceivers LogiCORE IP Product Guide* (PG132) [Ref 30] for more information.

The IBERT debug core lets you configure and control the major features of GTs on the device, including:

- TX pre-emphasis and post-emphasis
- TX differential swing
- RX equalization
- Decision Feedback Equalizer (DFE)
- Phase-Locked Loop (PLL) divider settings

You can use the IBERT core when you are interested in addressing a range of in-system debug and validation problems; from simple clocking and connectivity issues to complex margin analysis and channel optimization issues.

Related Objects

As seen in [Figure 2-22, page 81](#), the SIO IBERT debug cores are associated with `hw_server`, `hw_target`, `hw_device`, `hw_sio_gt`, `hw_sio_common`, `hw_sio_pll`, `hw_sio_tx`, `hw_sio_rx`, or `hw_sio_link` objects.

You can query the IBERT debug cores of associated objects:

```
get_hw_sio_iberts -of [get_hw_sio_plls *MGT_X0Y8/CPLL_0]
```

You can also query the associated objects of specific IBERT cores:

```
get_hw_sio_commons -of [get_hw_sio_iberts]
```

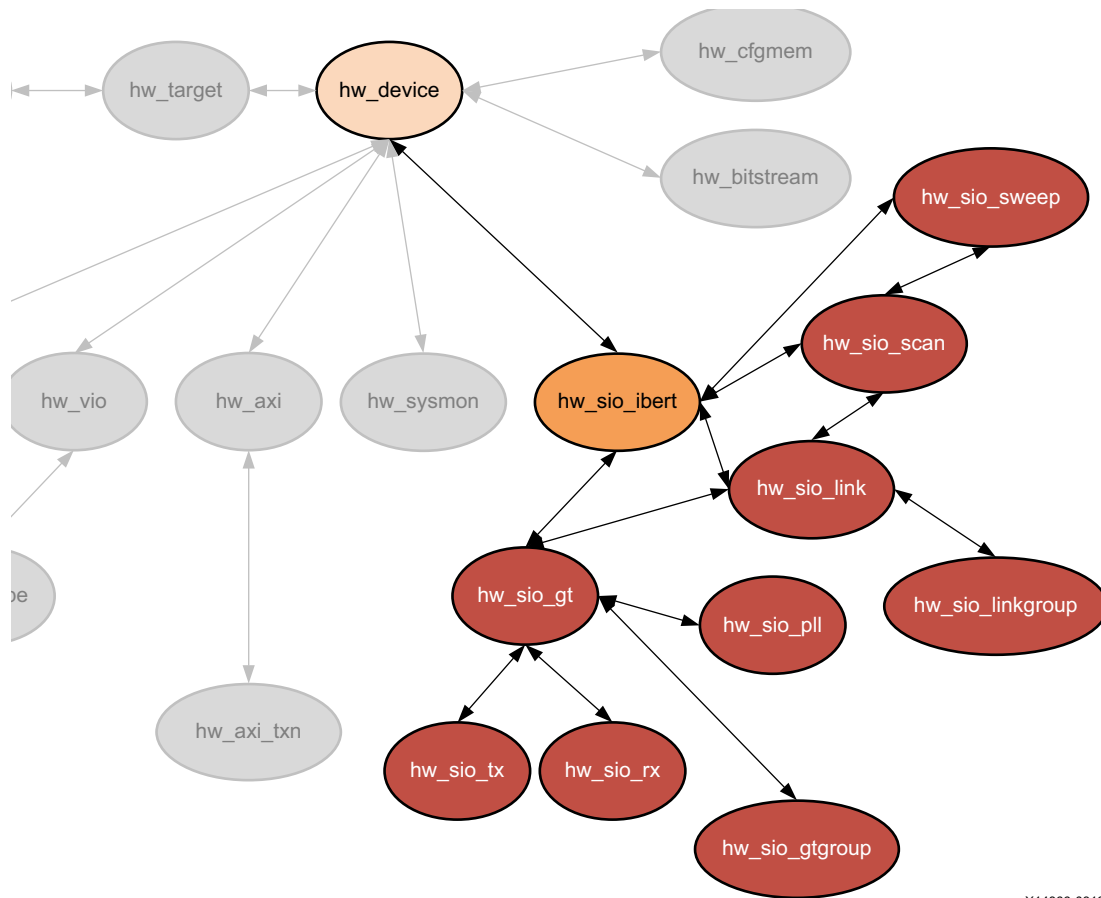

X14866-081315

Figure 2-22: Hardware SIO IBERT Object

Properties

You can use the `report_property` command to report the actual properties assigned to a specific `hw_sio_ibert`. Refer to the *Vivado Design Suite Tcl Command Reference Guide* (UG835) [Ref 13] for more information.

The properties assigned to `hw_sio_ibert` objects include the following:

Property	Type	Read-only	Visible	Value
CLASS	string	true	true	hw_sio_ibert
CORE_REFRESH_RATE_MS	int	false	true	0
DISPLAY_NAME	string	true	true	IBERT
NAME	string	true	true	
localhost/xilinx_tcf/Digilent/210203327463A/0_1/IBERT				
USER_REGISTER	int	true	true	1

To report the properties for a specific `hw_sio_ibert`, you can copy and paste the following command into the Vivado Design Suite Tcl shell or Tcl console:

```
report_property -all [lindex [get_hw_sio_iberts] 0]
```

HW_SIO_PLL

Description

For Xilinx FPGA devices having GigaBit Transceivers (GTs), each serial transceiver channel has a ring phase-locked loop (PLL) called Channel PLL (CPLL). For Xilinx UltraScale and 7 series FPGAs, the GTX has an additional shared PLL per quad, or Quad PLL (QPLL). This QPLL is a shared LC PLL to support high speed, high performance, and low power multi-lane applications.

Related Objects

HW_SIO_PLL objects are associated with hw_server, hw_target, hw_device, hw_sio_ibert, hw_sio_gt, or hw_sio_common objects.

You can query the PLLs of associated objects:

```
get_hw_sio_plls -of [get_hw_sio_commons]
```

And you can query the objects associated with a PLL:

```
get_hw_sio_iberts -of [get_hw_sio_plls *MGT_X0Y8/CPLL_0]
```

Properties

You can use the `report_property` command to report the properties assigned to a specific HW_SIO_PLL. Refer to the *Vivado Design Suite Tcl Command Reference Guide* (UG835) [Ref 13] for more information. The properties assigned to a shared QPLL type of HW_SIO_PLL object includes the following, with example values:

Property	Type	Read-only	Visible	Value
CLASS	string	true	true	hw_sio_pll
DISPLAY_NAME	string	true	true	COMMON_X0Y2/QPLL_0
DRP.QPLL_CFG	string	false	true	06801C1
DRP.QPLL_CLKOUT_CFG	string	false	true	0
DRP.QPLL_COARSE_FREQ_OVRD	string	false	true	10
DRP.QPLL_COARSE_FREQ_OVRD_EN	string	false	true	0
DRP.QPLL_CP	string	false	true	01F
DRP.QPLL_CP_MONITOR_EN	string	false	true	0
DRP.QPLL_DMONITOR_SEL	string	false	true	0
DRP.QPLL_FBDIV	string	false	true	0E0
DRP.QPLL_FBDIV_MONITOR_EN	string	false	true	1
DRP.QPLL_FBDIV_RATIO	string	false	true	1
DRP.QPLL_INIT_CFG	string	false	true	000028
DRP.QPLL_LOCK_CFG	string	false	true	21E8
DRP.QPLL_LOWER_BAND	string	false	true	1
DRP.QPLL_LPF	string	false	true	F
DRP.QPLL_REFCLK_DIV	string	false	true	10
LOGIC.QPLLRESET_CTRL	string	false	true	0

LOGIC.QPLLRESET_STAT	string	false	true	0
LOGIC.QPLL_LOCK	string	false	true	0
NAME	string	true	true	
localhost/xilinx_tcf/Digilent/210203327463A/0_1/IBERT/Quad_117/COMMON_X0Y2/QPLL_0				
PARENT	string	true	true	
localhost/xilinx_tcf/Digilent/210203327463A/0_1/IBERT/Quad_117/COMMON_X0Y2				
PORT.QPLLDMONITOR	string	false	true	EC
PORT.QPLLFCLKLOST	string	false	true	0
PORT.QPLLLOCK	string	false	true	1
PORT.QPLLLOCKEN	string	false	true	1
PORT.QPLLOUTRESET	string	false	true	0
PORT.QPLLPD	string	false	true	0
PORT.QPLLREFCLKLOST	string	false	true	0
PORT.QPLLREFCLKSEL	string	false	true	1
PORT.QPLLRESET	string	false	true	0
PORT.QPLLRSD1	string	false	true	0000
PORT.QPLLRSD2	string	false	true	1F
QPLLREFCLKSEL	enum	false	true	GTREFCLK0
QPLL_N_DIVIDER	enum	false	true	64
QPLL_REFCLK_DIV	enum	false	true	1
STATUS	string	false	true	LOCKED

To report the properties of the HW_SIO_PLL object, you can copy and paste the following command into the Vivado Design Suite Tcl shell or Tcl console:

```
report_property -all [lindex [get_hw_sio_plls] 0]
```

HW_SIO_RX

Description

On the hardware device, each GT includes an independent receiver, `hw_sio_rx`, which consists of a PCS and a PMA. High-speed serial data flows from traces on the board into the PMA of the GTX/GTH transceiver RX, into the PCS, and finally into the FPGA logic.

Related Objects

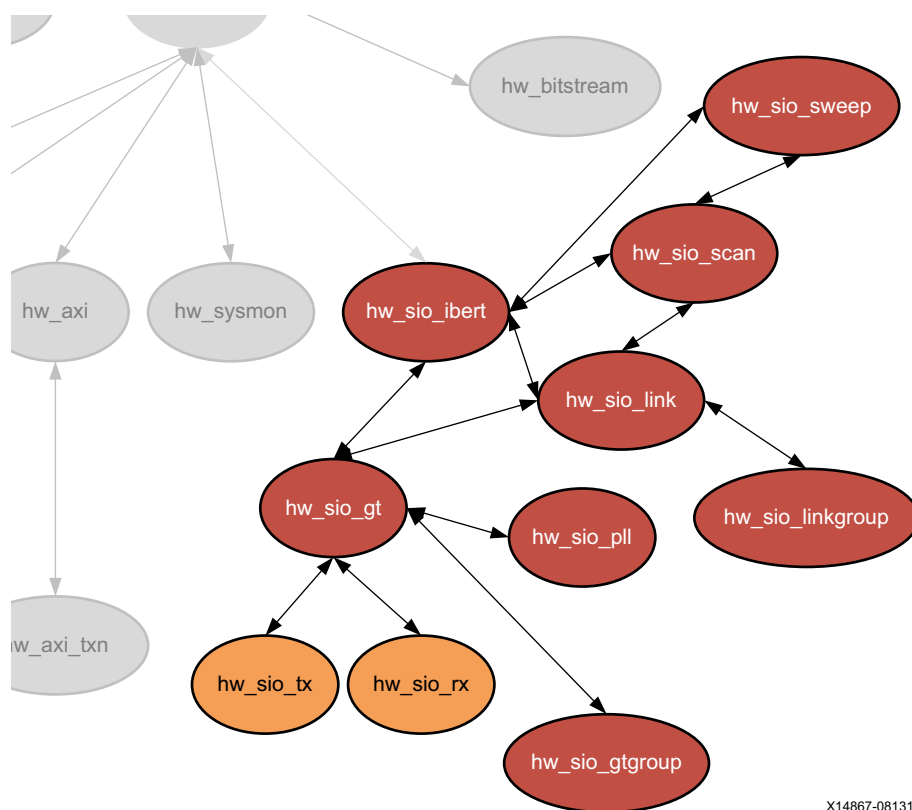

X14867-081315

Figure 2-23: Hardware SIO RX and TX Objects

HW_SIO_RX objects are associated with `hw_server`, `hw_target`, `hw_device`, `hw_sio_ibert`, `hw_sio_gt`, or `hw_sio_link` objects.

You can query the HW_SIO_RX objects of associated objects:

```
get_hw_sio_rxs -of [get_hw_sio_gts]
```

And you can query the objects associated with a specific HW_SIO_RX:

```
get_hw_sio_links -of [get_hw_sio_rxs]
```

Properties

You can use the `report_property` command to report the properties assigned to a specific HW_SIO_RX object. Refer to the *Vivado Design Suite Tcl Command Reference Guide* (UG835) [Ref 13] for more information. The properties assigned to hw_sio_rx objects include the following, with example values:

Property	Type	Read-only	Visible	Value
CLASS	string	true	true	hw_sio_rx
DISPLAY_NAME	string	true	true	MGT_X0Y8/RX
DRP.ES_CONTROL	string	false	true	00
DRP.ES_CONTROL_STATUS	string	false	true	0
DRP.ES_ERRDET_EN	string	false	true	0
DRP.ES_ERROR_COUNT	string	false	true	0000
DRP.ES_EYE_SCAN_EN	string	false	true	1
DRP.ES_HORZ_OFFSET	string	false	true	000
DRP.ES_PMA_CFG	string	false	true	000
DRP.ES_PRESCALE	string	false	true	00
DRP.ES_QUALIFIER	string	false	true	00000000000000000000
DRP.ES_QUAL_MASK	string	false	true	00000000000000000000
DRP.ES_RDATA	string	false	true	00000000000000000000
DRP.ES_SAMPLE_COUNT	string	false	true	0000
DRP.ES_SDATA	string	false	true	00000000000000000000
DRP.ES_SDATA_MASK	string	false	true	00000000000000000000
DRP.ES_UT_SIGN	string	false	true	0
DRP.ES_VERT_OFFSET	string	false	true	000
DRP.FTS_DESKEW_SEQ_ENABLE	string	false	true	F
DRP.FTS_LANE_DESKEW_CFG	string	false	true	F
DRP.FTS_LANE_DESKEW_EN	string	false	true	0
DRP.RXBUFRESET_TIME	string	false	true	01
DRP.RXBUF_ADDR_MODE	string	false	true	1
DRP.RXBUF_EIDLE_HI_CNT	string	false	true	8
DRP.RXBUF_EIDLE_LO_CNT	string	false	true	0
DRP.RXBUF_EN	string	false	true	1
DRP.RXBUF_RESET_ON_CB_CHANGE	string	false	true	1
DRP.RXBUF_RESET_ON_COMMAALIGN	string	false	true	0
DRP.RXBUF_RESET_ON_EIDLE	string	false	true	0
DRP.RXBUF_RESET_ON_RATE_CHANGE	string	false	true	1
DRP.RXBUF_THRESH_OVFLW	string	false	true	3D
DRP.RXBUF_THRESH_OVRD	string	false	true	0
DRP.RXBUF_THRESH_UNDFLW	string	false	true	04
DRP.RXCDRFREQRESET_TIME	string	false	true	01
DRP.RXCDRPHRESET_TIME	string	false	true	01
DRP.RXCDR_CFG	string	false	true	0B800023FF10200020
DRP.RXCDR_FR_RESET_ON_EIDLE	string	false	true	0
DRP.RXCDR_HOLD_DURING_EIDLE	string	false	true	0
DRP.RXCDR_LOCK_CFG	string	false	true	15
DRP.RXCDR_PH_RESET_ON_EIDLE	string	false	true	0
DRP.RXDLELPMRESET_TIME	string	false	true	0F
DRP.RXDLY_CFG	string	false	true	001F
DRP.RXDLY_LCFG	string	false	true	030
DRP.RXDLY_TAP_CFG	string	false	true	0000
DRP.RXGEARBOX_EN	string	false	true	0
DRP.RXISCANRESET_TIME	string	false	true	01
DRP.RXLPM_HF_CFG	string	false	true	00F0
DRP.RXLPM_LF_CFG	string	false	true	00F0
DRP.RXOOB_CFG	string	false	true	06

DRP.RXOUT_DIV	string	false	true	0
DRP.RXPCSRESET_TIME	string	false	true	01
DRP.RXPHDLY_CFG	string	false	true	084020
DRP.RXPH_CFG	string	false	true	000000
DRP.RXPH_MONITOR_SEL	string	false	true	00
DRP.RXPMARESET_TIME	string	false	true	03
DRP.RXPRBS_ERR_LOOPBACK	string	false	true	0
DRP.RXSLIDE_AUTO_WAIT	string	false	true	7
DRP.RXSLIDE_MODE	string	false	true	0
DRP.RX_BIAS_CFG	string	false	true	004
DRP.RX_BUFFER_CFG	string	false	true	00
DRP.RX_CLK25_DIV	string	false	true	04
DRP.RX_CLKMUX_PD	string	false	true	1
DRP.RX_CM_SEL	string	false	true	3
DRP.RX_CM_TRIM	string	false	true	4
DRP.RX_DATA_WIDTH	string	false	true	5
DRP.RX_DDI_SEL	string	false	true	00
DRP.RX_DEBUG_CFG	string	false	true	000
DRP.RX_DEFER_RESET_BUF_EN	string	false	true	1
DRP.RX_DFE_CTLE_STAGE1	string	false	true	8
DRP.RX_DFE_CTLE_STAGE2	string	false	true	3
DRP.RX_DFE_CTLE_STAGE3	string	false	true	0
DRP.RX_DFE_GAIN_CFG	string	false	true	020FEA
DRP.RX_DFE_H2_CFG	string	false	true	000
DRP.RX_DFE_H3_CFG	string	false	true	040
DRP.RX_DFE_H4_CFG	string	false	true	0F0
DRP.RX_DFE_H5_CFG	string	false	true	0E0
DRP.RX_DFE_KL_CFG2	string	false	true	3010D90C
DRP.RX_DFE_KL_CFG	string	false	true	00FE
DRP.RX_DFE_LPM_CFG	string	false	true	0954
DRP.RX_DFE_LPM_HOLD_DURING_EIDLE	string	false	true	0
DRP.RX_DFE_UT_CFG	string	false	true	11E00
DRP.RX_DFE_VP_CFG	string	false	true	03F03
DRP.RX_DFE_XYD_CFG	string	false	true	0000
DRP.RX_DISPERR_SEQ_MATCH	string	false	true	1
DRP.RX_INT_DATAWIDTH	string	false	true	1
DRP.RX_OS_CFG	string	false	true	0080
DRP.RX_SIG_VALID_DLY	string	false	true	09
DRP.RX_XCLK_SEL	string	false	true	0
DRP.TXBUF_RESET_ON_RATE_CHANGE	string	false	true	0
DRP.TXPCSRESET_TIME	string	false	true	01
DRP.TXPMARESET_TIME	string	false	true	01
DRP.TX_LOOPBACK_DRIVE_HIZ	string	false	true	0
DRP.TX_RXDETECT_CFG	string	false	true	1832
DRP.TX_RXDETECT_REF	string	false	true	4
ES_HORZ_MIN_MAX	string	false	true	32
LINE_RATE	string	false	true	0.000
LOGIC.ERRBIT_COUNT	string	false	true	000000000000
LOGIC.GT_SOURCES_SYSCLK	string	false	true	0
LOGIC.LINK	string	false	true	0
LOGIC.MGT_ERRCNT_RESET_CTRL	string	false	true	0
LOGIC.MGT_ERRCNT_RESET_STAT	string	false	true	0
LOGIC.MGT_RESET_CTRL	string	false	true	0
LOGIC.MGT_RESET_STAT	string	false	true	0
LOGIC.RXPAT_ID	string	false	true	1
LOGIC.RXRECCLK_FREQ_CNT	string	false	true	0000
LOGIC.RXRECCLK_FREQ_TUNE	string	false	true	4000
LOGIC.RXUSRCLK2_FREQ_CNT	string	false	true	0000
LOGIC.RXUSRCLK2_FREQ_TUNE	string	false	true	4000

LOGIC.RXUSRCLK_FREQ_CNT	string	false	true	0000
LOGIC.RXUSRCLK_FREQ_TUNE	string	false	true	4000
LOGIC.RXWORD_COUNT	string	false	true	000000000000
LOGIC.RX_DCM_LOCK	string	false	true	1
LOGIC.RX_DCM_RESET_CTRL	string	false	true	0
LOGIC.RX_DCM_RESET_STAT	string	false	true	0
LOGIC.RX_FRAMED	string	false	true	0
LOGIC.TX_DCM_RESET_CTRL	string	false	true	0
LOGIC.TX_DCM_RESET_STAT	string	false	true	1
LOOPBACK	enum	false	true	Near-End PCS
NAME	string	true	true	
localhost/xilinx_tcf/Digilent/210203327463A/0_1/IBERT/Quad_117/MGT_X0Y8/RX				
PARENT	string	true	true	
localhost/xilinx_tcf/Digilent/210203327463A/0_1/IBERT/Quad_117/MGT_X0Y8				
PORT.CFGRESET	string	false	true	0
PORT.CPLLRESET	string	false	true	0
PORT.EYESCANDATAERROR	string	false	true	0
PORT.EYESCANMODE	string	false	true	0
PORT.EYESCANRESET	string	false	true	0
PORT.EYESCANTRIGGER	string	false	true	0
PORT.GTRESETSEL	string	false	true	0
PORT.GTRXRESET	string	false	true	0
PORT.GTTXRESET	string	false	true	0
PORT.LOOPBACK	string	false	true	1
PORT.RESETOVRD	string	false	true	0
PORT.RX8B10BEN	string	false	true	0
PORT.RXBUFRESET	string	false	true	0
PORT.RXBUFSTATUS	string	false	true	0
PORT.RXBYTEISALIGNED	string	false	true	0
PORT.RXBYTEREALIGN	string	false	true	0
PORT.RXCDFREQRESET	string	false	true	0
PORT.RXCDRHOLD	string	false	true	0
PORT.RXCDRLOCK	string	false	true	0
PORT.RXCDRVRDEN	string	false	true	0
PORT.RXCDRRESET	string	false	true	0
PORT.RXCDRRESETRSV	string	false	true	0
PORT.RXCHANBONDSEQ	string	false	true	0
PORT.RXCHANISALIGNED	string	false	true	0
PORT.RXCHANREALIGN	string	false	true	0
PORT.RXCHARISCOMMA	string	false	true	00
PORT.RXCHARISK	string	false	true	00
PORT.RXCHBONDEN	string	false	true	0
PORT.RXCHBONDI	string	false	true	10
PORT.RXCHBONDLEVEL	string	false	true	0
PORT.RXCHBONDMASTER	string	false	true	0
PORT.RXCHBONDO	string	false	true	00
PORT.RXCHBONDSLAVE	string	false	true	0
PORT.RXCLKCORCNT	string	false	true	0
PORT.RXCOMINITDET	string	false	true	0
PORT.RXCOMMADET	string	false	true	0
PORT.RXCOMMADETEN	string	false	true	0
PORT.RXCOMSASDET	string	false	true	0
PORT.RXCOMWAKEDET	string	false	true	0
PORT.RXDATAVALID	string	false	true	0
PORT.RXDDIEN	string	false	true	0
PORT.RXDFEAGCHOLD	string	false	true	0
PORT.RXDFEAGCOVRDEN	string	false	true	0
PORT.RXDFECM1EN	string	false	true	0
PORT.RXDFELFHOLD	string	false	true	0

PORT.RXDFELFOVRDEN	string	false	true	0
PORT.RXDFELPMRESET	string	false	true	0
PORT.RXDFETAP2HOLD	string	false	true	0
PORT.RXDFETAP2OVRDEN	string	false	true	0
PORT.RXDFETAP3HOLD	string	false	true	0
PORT.RXDFETAP3OVRDEN	string	false	true	0
PORT.RXDFETAP4HOLD	string	false	true	0
PORT.RXDFETAP4OVRDEN	string	false	true	0
PORT.RXDFETAP5HOLD	string	false	true	0
PORT.RXDFETAP5OVRDEN	string	false	true	0
PORT.RXDFEUTHOLD	string	false	true	0
PORT.RXDFEUTOVRDEN	string	false	true	0
PORT.RXDFEVPHOLD	string	false	true	0
PORT.RXDFEVPOVRDEN	string	false	true	0
PORT.RXDFEVSEN	string	false	true	0
PORT.RXDFEXYDEN	string	false	true	0
PORT.RXDFEXYDHOLD	string	false	true	0
PORT.RXDFEXYDOVRDEN	string	false	true	0
PORT.RXDISPERR	string	false	true	00
PORT.RXDLYBPASS	string	false	true	1
PORT.RXDLYEN	string	false	true	0
PORT.RXDLYOVRDEN	string	false	true	0
PORT.RXDLYSRESET	string	false	true	0
PORT.RXDLYSRESETDONE	string	false	true	0
PORT.RXELECIDLE	string	false	true	1
PORT.RXELECIDLEMODE	string	false	true	0
PORT.RXGEARBOXSLIP	string	false	true	0
PORT.RXHEADER	string	false	true	0
PORT.RXHEADervalid	string	false	true	0
PORT.RXLPMEN	string	false	true	0
PORT.RXLPMHFHOLD	string	false	true	0
PORT.RXLPMHFovrden	string	false	true	0
PORT.RXLPLMFHOLD	string	false	true	0
PORT.RXLPLMFKLOVRDEN	string	false	true	0
PORT.RXMCOMMAALIGNEN	string	false	true	0
PORT.RXMONITOROUT	string	false	true	7F
PORT.RXMONITORSEL	string	false	true	0
PORT.RXNOTINTABLE	string	false	true	FF
PORT.RXOobRESET	string	false	true	0
PORT.RXOSHOLD	string	false	true	0
PORT.RXOSovrden	string	false	true	0
PORT.RXOUTCLKFABRIC	string	false	true	1
PORT.RXOUTCLKPCS	string	false	true	0
PORT.RXOUTCLKSEL	string	false	true	1
PORT.RXPCommaALIGNEN	string	false	true	0
PORT.RXPcsRESET	string	false	true	0
PORT.RXPd	string	false	true	0
PORT.RXPALIGN	string	false	true	0
PORT.RXPALIGNDONE	string	false	true	0
PORT.RXPALIGNEN	string	false	true	0
PORT.RXPdLYPD	string	false	true	0
PORT.RXPdLYRESET	string	false	true	0
PORT.RXPdMONITOR	string	false	true	00
PORT.RXPdHOVRDEN	string	false	true	0
PORT.RXPdSLIPMONITOR	string	false	true	04
PORT.RXPdARESET	string	false	true	0
PORT.RXPdPOLARITY	string	false	true	0
PORT.RXPdRBSCTRESET	string	false	true	0
PORT.RXPdRBSERR	string	false	true	0

PORT.RXPRBSSEL	string	false	true	0
PORT.RXQPIEN	string	false	true	0
PORT.RXQPISENN	string	false	true	0
PORT.RXQPISENP	string	false	true	0
PORT.RXRATE	string	false	true	0
PORT.RXRATEDONE	string	false	true	0
PORT.RXRESETDONE	string	false	true	0
PORT.RXSLIDE	string	false	true	0
PORT.RXSTARTOFSEQ	string	false	true	0
PORT.RXSTATUS	string	false	true	0
PORT.RXSYSCLKSEL	string	false	true	3
PORT.RXUSERRDY	string	false	true	1
PORT.RXVALID	string	false	true	0
PORT.TXDETECTRX	string	false	true	0
PORT.TXDLYSRESET	string	false	true	0
PORT.TXDLYSRESETDONE	string	false	true	0
PORT.TXPCSRESET	string	false	true	0
PORT.TXPHDLYRESET	string	false	true	0
PORT.TXPMARESET	string	false	true	0
PORT.TXRESETDONE	string	false	true	0
RXDFEENABLED	enum	false	true	1
RXOUTCLKSEL	enum	false	true	RXOUTCLKPCS
RXOUT_DIV	enum	false	true	1
RXPLL	enum	false	true	QPLL
RXRATE	enum	false	true	Use RX_OUT_DIV
RXTERM	enum	false	true	900 mV
RXTERMMODE	enum	false	true	Programmable
RXUSRCLK2_FREQ	string	false	true	0.048828
RXUSRCLK_FREQ	string	false	true	0.048828
RX_BER	string	false	true	inf
RX_DATA_WIDTH	enum	false	true	40
RX_DFE_CTLE	enum	false	true	
RX_INTERNAL_DATAPATH	enum	false	true	4-byte
RX_PATTERN	enum	false	true	PRBS 7-bit
RX_PLL	string	true	true	
localhost/xilinx_tcf/Digilent/210203327463A/0_1/IBERT/Quad_117/COMMON_X0Y2/QPLL_0				
RX_RECEIVED_BIT_COUNT	string	false	true	0
STATUS	string	false	true	NO LINK

To report the properties for a HW_SIO_RX object, you can copy and paste the following command into the Vivado Design Suite Tcl shell or Tcl console:

```
report_property -all [lindex [get_hw_sio_rxs] 0]
```

HW_SIO_TX

Description

On the hardware device, each GT includes an independent transmitter, `hw_sio_tx`, which consists of a PCS and a PMA. Parallel data flows from the device logic into the FPGA TX interface, through the PCS and PMA, and then out the TX driver as high-speed serial data.

Related Objects

See [Figure 2-23, page 84](#) for an illustration of the relationship that the `HW_SIO_TX` object has with other hardware objects. `HW_SIO_TX` objects are associated with `hw_server`, `hw_target`, `hw_device`, `hw_sio_ibert`, `hw_sio_gt`, or `hw_sio_link` objects.

You can query the `HW_SIO_TX` objects of associated objects:

```
get_hw_sio_txs -of [get_hw_sio_gts]
```

And you can query the objects associated with a specific `HW_SIO_TX`:

```
get_hw_sio_links -of [get_hw_sio_txs]
```

Properties

You can use the `report_property` command to report the properties assigned to a specific `HW_SIO_TX` object. Refer to the *Vivado Design Suite Tcl Command Reference Guide* (UG835) [\[Ref 13\]](#) for more information. The properties assigned to `HW_ILA` objects include the following, with example values:

Property	Type	Read-only	Visible	Value
CLASS	string	true	true	hw_sio_tx
DISPLAY_NAME	string	true	true	MGT_X0Y8/TX
DRP.TXBUF_EN	string	false	true	1
DRP.TXBUF_RESET_ON_RATE_CHANGE	string	false	true	0
DRP.TXDLY_CFG	string	false	true	001F
DRP.TXDLY_LCFG	string	false	true	030
DRP.TXDLY_TAP_CFG	string	false	true	0000
DRP.TXGEARBOX_EN	string	false	true	0
DRP.TXOUT_DIV	string	false	true	0
DRP.TXPCSRESET_TIME	string	false	true	01
DRP.TXPHDLY_CFG	string	false	true	084020
DRP.TXPH_CFG	string	false	true	0780
DRP.TXPH_MONITOR_SEL	string	false	true	00
DRP.TXPMARESET_TIME	string	false	true	01
DRP.TX_CLK25_DIV	string	false	true	04
DRP.TX_CLKMUX_PD	string	false	true	1
DRP.TX_DATA_WIDTH	string	false	true	5
DRP.TX_DEEMPH0	string	false	true	00
DRP.TX_DEEMPH1	string	false	true	00
DRP.TX_DRIVE_MODE	string	false	true	00

DRP.TX_EIDLE_ASSERT_DELAY	string	false	true	6
DRP.TX_EIDLE_DEASSERT_DELAY	string	false	true	4
DRP.TX_INT_DATAWIDTH	string	false	true	1
DRP.TX_LOOPBACK_DRIVE_HIZ	string	false	true	0
DRP.TX_MAINCURSOR_SEL	string	false	true	0
DRP.TX_MARGIN_FULL_0	string	false	true	4E
DRP.TX_MARGIN_FULL_1	string	false	true	49
DRP.TX_MARGIN_FULL_2	string	false	true	45
DRP.TX_MARGIN_FULL_3	string	false	true	42
DRP.TX_MARGIN_FULL_4	string	false	true	40
DRP.TX_MARGIN_LOW_0	string	false	true	46
DRP.TX_MARGIN_LOW_1	string	false	true	44
DRP.TX_MARGIN_LOW_2	string	false	true	42
DRP.TX_MARGIN_LOW_3	string	false	true	40
DRP.TX_MARGIN_LOW_4	string	false	true	40
DRP.TX_PREDRIVER_MODE	string	false	true	0
DRP.TX_QPI_STATUS_EN	string	false	true	0
DRP.TX_RXDETECT_CFG	string	false	true	1832
DRP.TX_RXDETECT_REF	string	false	true	4
DRP.TX_XCLK_SEL	string	false	true	0
LOGIC.ERR_INJECT_CTRL	string	false	true	0
LOGIC.TXOUTCLK_FREQ_CNT	string	false	true	0000
LOGIC.TXOUTCLK_FREQ_TUNE	string	false	true	4000
LOGIC.TXPAT_ID	string	false	true	1
LOGIC.TXUSRCLK2_FREQ_CNT	string	false	true	0000
LOGIC.TXUSRCLK2_FREQ_TUNE	string	false	true	4000
LOGIC.TXUSRCLK_FREQ_CNT	string	false	true	0000
LOGIC.TXUSRCLK_FREQ_TUNE	string	false	true	4000
LOGIC.TX_DCM_LOCK	string	false	true	1
LOGIC.TX_DCM_RESET_CTRL	string	false	true	0
LOGIC.TX_DCM_RESET_STAT	string	false	true	1
LOGIC.TX_FRAMED	string	false	true	0
NAME	string	true	true	
localhost/xilinx_tcf/Digilent/210203327463A/0_1/IBERT/Quad_117/MGT_X0Y8/TX				
PARENT	string	true	true	
localhost/xilinx_tcf/Digilent/210203327463A/0_1/IBERT/Quad_117/MGT_X0Y8				
PORT.GTTXRESET	string	false	true	0
PORT.TX8B10BYPASS	string	false	true	FF
PORT.TX8B10BEN	string	false	true	0
PORT.TXBUFFDIFFCTRL	string	false	true	4
PORT.TXBUFFSTATUS	string	false	true	0
PORT.TXCHARDISPMODE	string	false	true	00
PORT.TXCHARDISPVAL	string	false	true	00
PORT.TXCHARISK	string	false	true	00
PORT.TXCOMFINISH	string	false	true	0
PORT.TXCOMINIT	string	false	true	0
PORT.TXCOMSAS	string	false	true	0
PORT.TXCOMWAKE	string	false	true	0
PORT.TXDEEMPH	string	false	true	0
PORT.TXDETECTRX	string	false	true	0
PORT.TXDIFFFCTRL	string	false	true	C
PORT.TXDIFFFPD	string	false	true	0
PORT.TXDLYBYPASS	string	false	true	1
PORT.TXDLYEN	string	false	true	0
PORT.TXDLYHOLD	string	false	true	0
PORT.TXDLYOVRDEN	string	false	true	0
PORT.TXDLYSRESET	string	false	true	0
PORT.TXDLYSRESETDONE	string	false	true	0
PORT.TXDLYUPDOWN	string	false	true	0

PORT.TXELECIDLE	string	false	true	0
PORT.TXGEARBOXREADY	string	false	true	0
PORT.TXHEADER	string	false	true	0
PORT.TXINHIBIT	string	false	true	0
PORT.TXMAINCURSOR	string	false	true	00
PORT.TXMARGIN	string	false	true	0
PORT.TXOUTCLKFABRIC	string	false	true	1
PORT.TXOUTCLKPCS	string	false	true	0
PORT.TXOUTCLKSEL	string	false	true	2
PORT.TXPCSRESET	string	false	true	0
PORT.TXPD	string	false	true	0
PORT.TXPDELECIDLEMODE	string	false	true	0
PORT.TXPHALIGN	string	false	true	0
PORT.TXPHALIGNDONE	string	false	true	0
PORT.TXPHALIGNEN	string	false	true	0
PORT.TXPHDLYPD	string	false	true	0
PORT.TXPHDLYRESET	string	false	true	0
PORT.TXPHDLYTSTCLK	string	false	true	0
PORT.TXPHINIT	string	false	true	0
PORT.TXPHINITDONE	string	false	true	0
PORT.TXPHOVRDEN	string	false	true	0
PORT.TXPISOPD	string	false	true	0
PORT.TXPMARESET	string	false	true	0
PORT.TXPOLARITY	string	false	true	0
PORT.TXPOSTCURSOR	string	false	true	03
PORT.TXPOSTCURSORINV	string	false	true	0
PORT.TXPRBSFORCEERR	string	false	true	0
PORT.TXPRBSSEL	string	false	true	0
PORT.TXPRECURSOR	string	false	true	07
PORT.TXPRECURSORINV	string	false	true	0
PORT.TXQPIBIASEN	string	false	true	0
PORT.TXQPISENN	string	false	true	0
PORT.TXQPISENP	string	false	true	0
PORT.TXQPISTRONGPDOWN	string	false	true	0
PORT.TXQPIWEAKPUP	string	false	true	0
PORT.TXRATE	string	false	true	0
PORT.TXRATEDONE	string	false	true	0
PORT.TXRESETDONE	string	false	true	0
PORT.TXSEQUENCE	string	false	true	00
PORT.TXSTARTSEQ	string	false	true	0
PORT.TXSWING	string	false	true	0
PORT.TXSYSCLKSEL	string	false	true	3
PORT.TXUSERRDY	string	false	true	1
TXDIFFSWING	enum	false	true	1.018 V (1100)
TXOUTCLKSEL	enum	false	true	TXOUTCLKPMA
TXOUT_DIV	enum	false	true	1
TXPLL	enum	false	true	QPLL
TXPOST	enum	false	true	0.68 dB (00011)
TXPRE	enum	false	true	1.67 dB (00111)
TXRATE	enum	false	true	Use TXOUT_DIV
TXUSRCLK2_FREQ	string	false	true	0.048828
TXUSRCLK_FREQ	string	false	true	0.048828
TX_DATA_WIDTH	enum	false	true	40
TX_INTERNAL_DATAPATH	enum	false	true	4-byte
TX_PATTERN	enum	false	true	PRBS 7-bit
TX_PLL	string	true	true	
localhost/xilinx_tcf/Digilent/210203327463A/0_1/IBERT/Quad_117/COMMON_X0Y2/QPLL_0				

To report the properties for a HW_SIO_TX object, you can copy and paste the following command into the Vivado Design Suite Tcl shell or Tcl console:

```
report_property -all [lindex [get_hw_sio_txs] 0]
```

HW_SYSMON

Description

The System Monitor, HW_SYSMON, is an Analog-to-Digital Converter (ADC) circuit on Xilinx devices, used to measure operating conditions such as temperature and voltage. The HW_SYSMON monitors the physical environment via on-chip temperature and supply sensors. The ADC provides a high-precision analog interface for a range of applications. The ADC can access up to 17 external analog input channels.

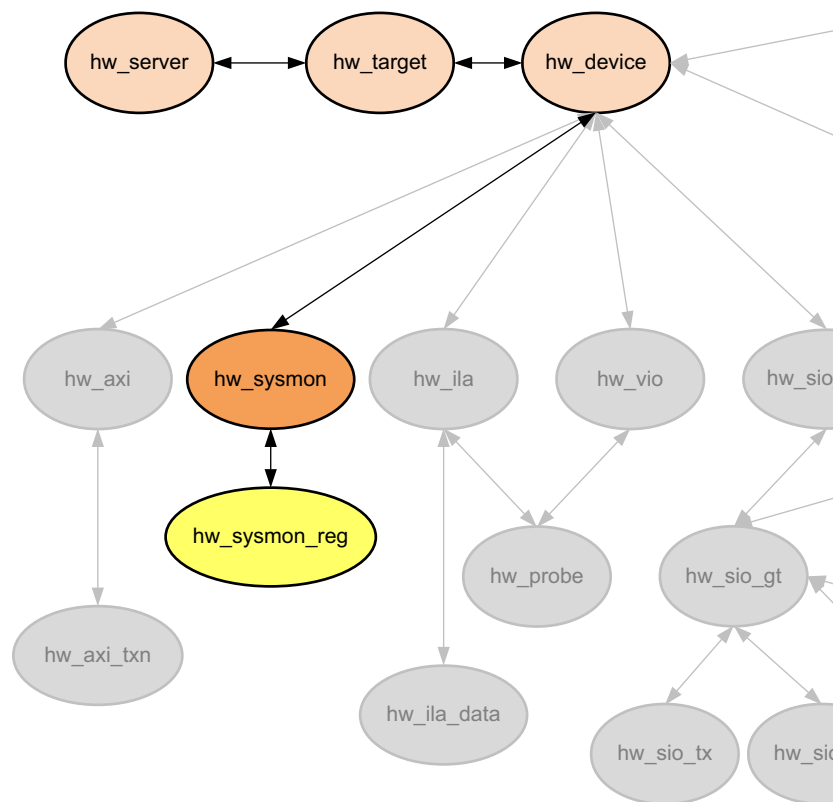

Figure 2-24: Hardware Sysmon Object

The HW_SYSMON has data registers, or HW_SYSMON_REG objects, that store the current values of temperatures and voltages. The values in these registers on the current hw_device can be accessed through the Hardware Manager feature of the Vivado Design Suite, when connected to a hardware server and target. The HW_SYSMON varies between Virtex-7 devices and UltraScale devices. Refer to the *UltraScale Architecture System Monitor Advance Specification User Guide* (UG580) [Ref 12] or the *7 Series FPGAs and Zynq-7000 SoC XADC Dual 12-Bit 1 MSPS Analog-to-Digital Converter User Guide* (UG480) [Ref 6] or for more information on the specific registers of the XADC and how to address them.

Although you can use the `get_hw_sysmon_reg` command to access the hex values stored in registers of a system monitor, you can also retrieve values of certain registers as formatted properties of the `hw_sysmon` object. For example, the following code retrieves the `TEMPERATURE` property of the specified `hw_sysmon` object rather than directly accessing the hex value of the register:

```
get_property TEMPERATURE [get_hw_sysmons]
```

Related Objects

The `HW_SYSMON` object can be found in the Hardware Manager on the programmed `hw_device`, on the current `hw_target` and `hw_server`. You can query the `hw_sysmon` of the `hw_device` as follows:

```
get_hw_sysmons -of [get_hw_devices]
```

Properties

You can use the `report_property` command to report the actual properties assigned to `HW_SYSMON` objects. Refer to the *Vivado Design Suite Tcl Command Reference Guide* (UG835) [Ref 13] for more information.

To report the properties for the `HW_SYSMON` you can copy and paste the following command into the Vivado Design Suite Tcl shell or Tcl console:

```
report_property -all [lindex [get_hw_sysmons] 0]
```

The following are the properties found on the `hw_sysmon` object:

Property	Type	Read-only	Visible	Value
ADC_A_GAIN	hex	true	true	0000
ADC_A_OFFSET	hex	true	true	007e
ADC_B_GAIN	hex	true	true	0000
ADC_B_OFFSET	hex	true	true	ffbb
CLASS	string	true	true	hw_sysmon
CONFIG_REG.ACQ	binary	false	true	0
CONFIG_REG.ALM0	binary	false	true	0
CONFIG_REG.ALM1	binary	false	true	0
CONFIG_REG.ALM2	binary	false	true	0
CONFIG_REG.ALM3	binary	false	true	0
CONFIG_REG.ALM4	binary	false	true	0
CONFIG_REG.ALM5	binary	false	true	0
CONFIG_REG.ALM6	binary	false	true	0
CONFIG_REG.AVG	binary	false	true	00
CONFIG_REG.BU	binary	false	true	0
CONFIG_REG.CAL0	binary	false	true	0
CONFIG_REG.CAL1	binary	false	true	0
CONFIG_REG.CAL2	binary	false	true	0
CONFIG_REG.CAL3	binary	false	true	0
CONFIG_REG.CAVG	binary	false	true	0
CONFIG_REG.CD	binary	false	true	00000000
CONFIG_REG.CH	binary	false	true	00000
CONFIG_REG.EC	binary	false	true	0

CONFIG_REG.MUX	binary	false	true	0
CONFIG_REG.OT	binary	false	true	0
CONFIG_REG.PD	binary	false	true	00
CONFIG_REG.SEQ	binary	false	true	0000
DESCRIPTION	string	true	true	XADC
FLAG.ALM0	binary	true	true	0
FLAG.ALM1	binary	true	true	0
FLAG.ALM2	binary	true	true	0
FLAG.ALM3	binary	true	true	0
FLAG.ALM4	binary	true	true	0
FLAG.ALM5	binary	true	true	0
FLAG.ALM6	binary	true	true	0
FLAG.JTGD	binary	true	true	0
FLAG.JTGR	binary	true	true	0
FLAG.OT	binary	true	true	0
FLAG.REF	binary	true	true	0
LOWER_TEMPERATURE	string	false	true	-273.1
LOWER_TEMPERATURE_SCALE	enum	false	true	CELSIUS
LOWER_VCCAUX	string	false	true	0.000
LOWER_VCCBRAM	string	false	true	0.000
LOWER_VCCINT	string	false	true	0.000
LOWER_VCCO_DDR	string	false	true	0.000
LOWER_VCCPAUX	string	false	true	0.000
LOWER_VCCPINT	string	false	true	0.000
MAX_TEMPERATURE	string	true	true	41.7
MAX_TEMPERATURE_SCALE	enum	false	true	CELSIUS
MAX_VCCAUX	string	true	true	1.805
MAX_VCCBRAM	string	true	true	0.997
MAX_VCCINT	string	true	true	1.000
MAX_VCCO_DDR	string	true	true	0.000
MAX_VCCPAUX	string	true	true	0.000
MAX_VCCPINT	string	true	true	0.000
MIN_TEMPERATURE	string	true	true	37.3
MIN_TEMPERATURE_SCALE	enum	false	true	CELSIUS
MIN_VCCAUX	string	true	true	1.800
MIN_VCCBRAM	string	true	true	0.993
MIN_VCCINT	string	true	true	0.997
MIN_VCCO_DDR	string	true	true	2.999
MIN_VCCPAUX	string	true	true	2.999
MIN_VCCPINT	string	true	true	2.999
NAME	string	true	true	
localhost/xilinx_tcf/Digilent/210203336599A/xc7k325t_0/SYSMON				
SUPPLY_A_OFFSET	hex	true	true	006b
SUPPLY_B_OFFSET	hex	true	true	ffa9
SYSMON_REFRESH_RATE_MS	int	false	true	0
TEMPERATURE	string	true	true	37.8
TEMPERATURE_SCALE	enum	false	true	CELSIUS
UPPER_TEMPERATURE	string	false	true	-273.1
UPPER_TEMPERATURE_SCALE	enum	false	true	CELSIUS
UPPER_VCCAUX	string	false	true	0.000
UPPER_VCCBRAM	string	false	true	0.000
UPPER_VCCINT	string	false	true	0.000
UPPER_VCCO_DDR	string	false	true	0.000
UPPER_VCCPAUX	string	false	true	0.000
UPPER_VCCPINT	string	false	true	0.000
VAUXP0_VAUXN0	string	true	true	0.000
VAUXP1_VAUXN1	string	true	true	0.000
VAUXP2_VAUXN2	string	true	true	0.000
VAUXP3_VAUXN3	string	true	true	0.000

VAUXP4_VAUXN4	string	true	true	0.000
VAUXP5_VAUXN5	string	true	true	0.000
VAUXP6_VAUXN6	string	true	true	0.000
VAUXP7_VAUXN7	string	true	true	0.000
VAUXP8_VAUXN8	string	true	true	0.000
VAUXP9_VAUXN9	string	true	true	0.000
VAUXP10_VAUXN10	string	true	true	0.000
VAUXP11_VAUXN11	string	true	true	0.000
VAUXP12_VAUXN12	string	true	true	0.000
VAUXP13_VAUXN13	string	true	true	0.000
VAUXP14_VAUXN14	string	true	true	0.000
VAUXP15_VAUXN15	string	true	true	0.000
VCCAUX	string	true	true	1.802
VCCBRAM	string	true	true	0.995
VCCINT	string	true	true	0.999
VCCO_DDR	string	true	true	0.000
VCCPAUX	string	true	true	0.000
VCCPINT	string	true	true	0.000
VP_VN	string	true	true	0.000
VREFN	string	true	true	0.000
VREFP	string	true	true	0.000

HW_TARGET

Description

The hardware target, `hw_target`, is a system board containing a JTAG chain of one or more Xilinx FPGA devices that you can program with a bitstream file, or use to debug your design. Connections between hardware targets on the system board and the Vivado Design Suite are managed by a hardware server object, `hw_server`.

Use the `open_hw_target` command to open a connection to one of the available hardware targets. The open target is automatically defined as the current hardware target. The Vivado logic analyzer directs programming and debug commands to FPGA objects, `hw_device`, on the open target through the `hw_server` connection.

You can also open the `hw_target` using the `-jtag_mode` option of the `open_hw_target` command, to put the target into JTAG test mode to access the Instruction Register (IR) and Data Registers (DR) of the device or devices on the target. When the target is opened in JTAG mode, a `hw_jtag` object is created in the Hardware Manager feature of the Vivado Design Suite, providing access to the JTAG TAP controller.

Refer to *Vivado Design Suite User Guide: Programming and Debugging* (UG908) [Ref 23] for a list of supported JTAG download cables and devices.

Related Objects

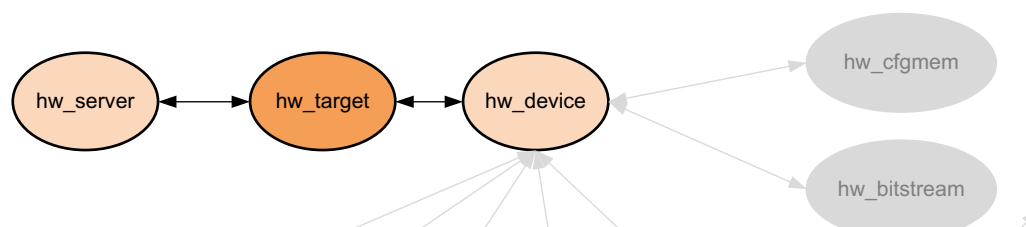

Figure 2-25: Hardware Target Objects

Hardware targets are associated with hardware servers, and can be queried as objects of the `hw_server` object:

```
get_hw_target -of [get_hw_servers]
```

In addition, you can query the hardware devices associated with a hardware target:

```
get_hw_devices -of [current_hw_target]
```

When the target is opened in JTAG mode you can access the `hw_jtag` object created through the `HW_JTAG` property on the target:

```
get_property HW_JTAG [current_hw_target]
```

Properties

You can use the `report_property` command to report the properties assigned to a `hw_target` object. Refer to the *Vivado Design Suite Tcl Command Reference Guide* (UG835) [Ref 13] for more information. The properties assigned to the `hw_target` object include the following, with example values:

Property	Type	Read-only	Visible	Value
CLASS	string	true	true	hw_target
DEVICE_COUNT	int	true	true	1
HW_JTAG	hw_jtag	true	true	
IS_OPENED	bool	true	true	1
NAME	string	true	true	
				localhost/xilinx_tcf/Digilent/210203327463A
PARAM.DEVICE	string	true	true	jsn-JTAG-SMT1-210203327463A
PARAM.FREQUENCY	enum	true	true	15000000
PARAM.TYPE	string	true	true	xilinx_tcf
TID	string	true	true	jsn-JTAG-SMT1-210203327463A
UID	string	true	true	Digilent/210203327463A

To report the properties for a `hw_target`, you can copy and paste the following command into the Vivado Design Suite Tcl shell or Tcl console:

```
report_property -all [get_hw_targets]
```

HW_VIO

Description

The Virtual Input/Output (VIO) debug core, `hw_vio`, can both monitor and drive internal signals on a programmed Xilinx FPGA in real time. In the absence of physical access to the target hardware, you can use this debug feature to drive and monitor signals that are present on the physical device.

The VIO core has hardware probes, `hw_probe` objects, to monitor and drive specific signals on the design. Input probes monitor signals as inputs to the VIO core. Output probes drive signals to specified values from the VIO core. Values on the probe are defined using the `set_property` command, and are driven onto the signals at the probe using the `commit_hw_vio` command.

The VIO debug core must be instantiated in the RTL code, from the Xilinx IP catalog. Therefore you need to know what nets you want monitor and drive prior to debugging the design. The IP Catalog provides the VIO core under the Debug category. Detailed documentation on the VIO core can be found in the *Virtual Input/Output LogiCORE IP Product Guide* (PG159) [Ref 31].

Related Objects

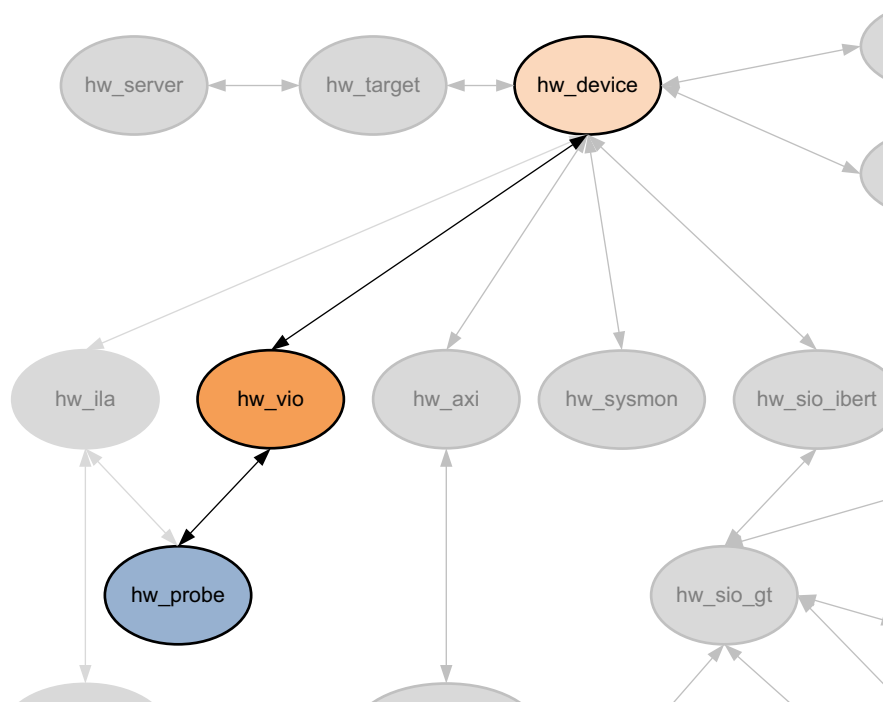

Figure 2-26: Hardware VIO Object

VIO debug cores can be added to a design in the RTL source files from the Xilinx IP catalog. Debug cores can be found in the synthesized netlist design using the `get_debug_cores` command. These are not the hardware VIO debug core objects, `hw_vio`, found in the Hardware Manager feature of the Vivado Design Suite, though they are related.

The hardware VIO debug core can be found in the Hardware Manager on the programmed hardware device object, `hw_device`. You can query the `hw_vio` of the `hw_device` as follows:

```
get_hw_vios -of [current_hw_device]
```

In addition, the `hw_vio` debug core has probes associated with it, that can also be queried:

```
get_hw_probes -of [get_hw_vios]
```

Properties

You can use the `report_property` command to report the properties assigned to a HW_VIO object. Refer to the *Vivado Design Suite Tcl Command Reference Guide* (UG835) [Ref 13] for more information.

Property	Type	Read-only	Visible	Value
CLASS	string	true	true	hw_vio
CORE_REFRESH_RATE_MS	int	false	true	500
HW_CORE	string	true	false	core_1
INSTANCE_NAME	string	true	true	i_vio_new
IS_ACTIVITY_SUPPORTED	bool	true	true	1
NAME	string	true	true	hw_vio_1

To report the properties for a HW_VIO object, you can copy and paste the following command into the Vivado Design Suite Tcl shell or Tcl console:

```
report_property -all [lindex [get_hw_vios] 0]
```

IO_BANK

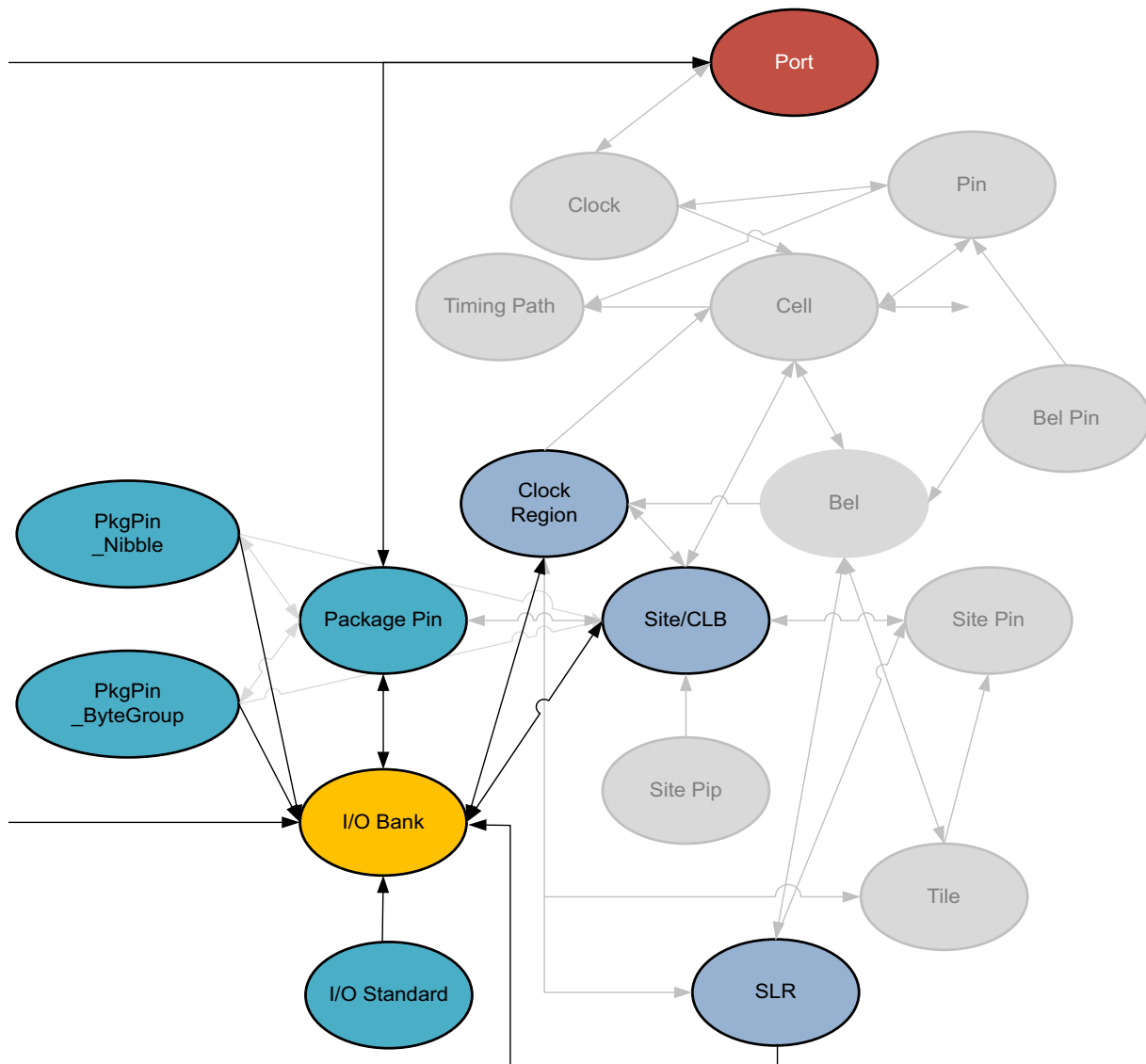

Figure 2-27: IO_BANK Objects

Description

The Xilinx 7 series FPGAs, and UltraScale architecture offer both high-performance (HP) and high-range (HR) I/O banks. I/O banks are collections of I/O blocks (IOBs), with configurable SelectIO drivers and receivers, supporting a wide variety of standard interfaces, both single-ended and differential. The HP I/O banks are designed to meet the performance requirements of high-speed memory and other chip-to-chip interfaces with voltages up to 1.8V. The HR I/O banks are designed to support a wider range of I/O standards with voltages up to 3.3V.

Each I/O bank includes programmable control of output strength and slew rate, on-chip termination using digitally-controlled impedance (DCI), and the ability to internally generate a reference voltage (INTERNAL_VREF).

In UltraScale devices, most I/O banks consist of 52 IOBs, although HR I/O mini-banks consist of 26 IOBs. While in 7 series devices, most I/O banks include 50 IOBs, which matches the height of a clock region. The number of I/O banks on the device depends upon the size and the package pinout.

For more information on I/O banks, and the rules related to I/O assignments, refer to *7 Series FPGAs SelectIO Resources User Guide* (UG471) [Ref 2] and *UltraScale Architecture SelectIO Resources User Guide* (UG571) [Ref 8].

Related Objects

From [Figure 2-27, page 102](#) you can see that I/O banks are related to the port netlist object, the package_pin for the device, and the I/O standard being implemented by the I/O block. You can get the io_banks of associated package_pins, ports, clock regions or sites:

```
get_iobanks -of [get_clock_regions X0Y2]
```

You can also query the port, clock_region, site, SLR, I/O standard, package_pin, pkgpin_bytegroup, and pkgpin_nibble objects associated with an I/O bank:

```
get_sites -of [get_iobanks 227]
```

Properties

The properties found on I/O Bank objects are as follows, with example values:

Property	Type	Read-only	Value
BANK_TYPE	string	true	BT_HIGH_PERFORMANCE
CLASS	string	true	iobank
DCI_CASCADE	string*	false	
INTERNAL_VREF	double	false	
IS_MASTER	bool	true	0
IS_SLAVE	bool	true	0
MASTER_BANK	string	true	
NAME	string	true	46
VCCOSENSEMODE	string	false	

The properties of an io_bank can be listed with the following command:

```
report_property -all [lindex [get_iobanks] 0]
```

IO_STANDARD

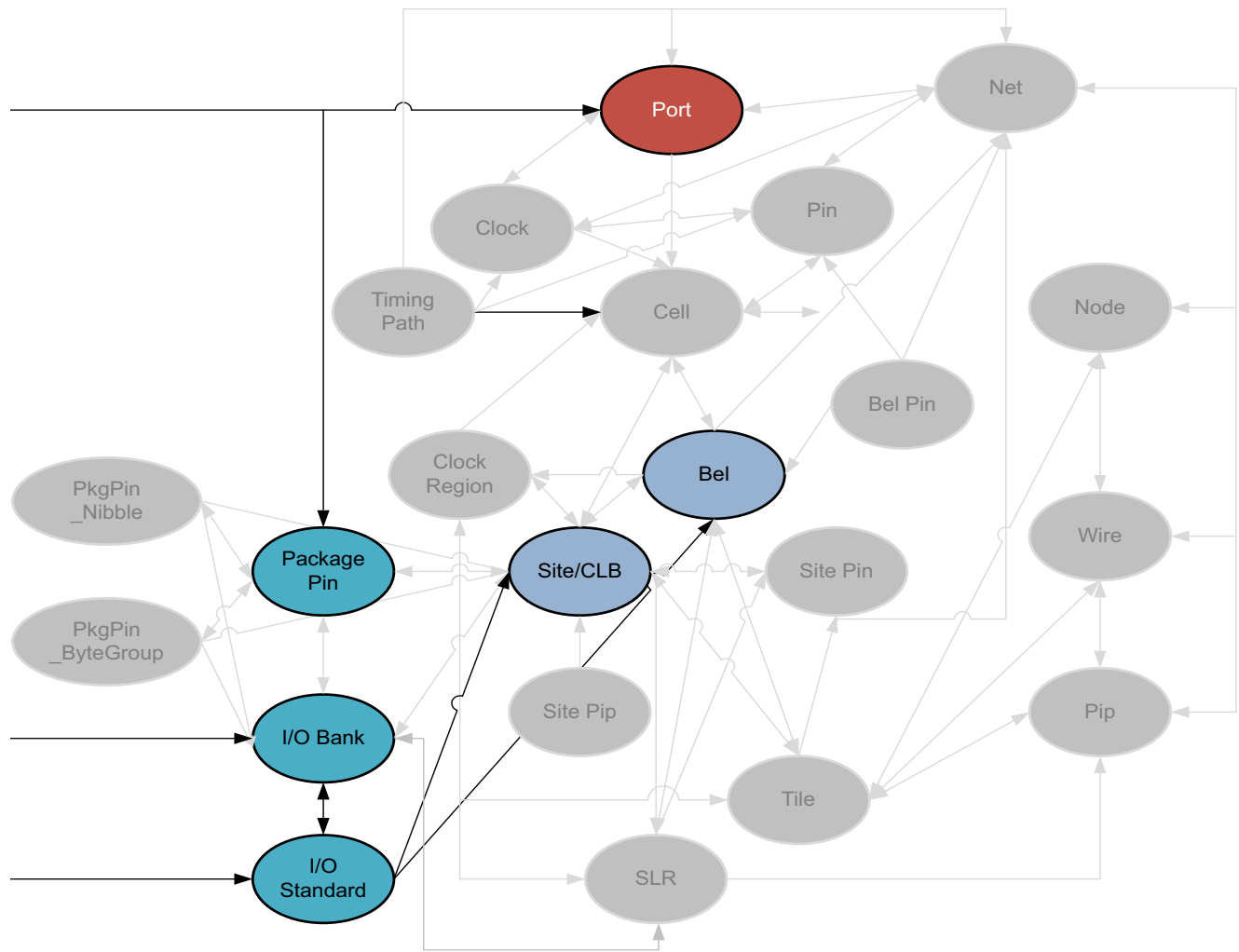

X14872-081315

Figure 2-28: IO_STANDARD Objects

Description

IO_STANDARD objects define the available IOSTANDARDS supported by the target Xilinx device. The IO_STANDARD object can be assigned to PORT objects through the **IOSTANDARD** property to configure input, output, or bidirectional ports in the current design. For more information on supported standards, refer to *7 Series FPGAs SelectIO Resources User Guide (UG471)* [Ref 2] and *UltraScale Architecture SelectIO Resources User Guide (UG571)* [Ref 8].

Related Objects

You can query the IO_STANDARD associated with specific BELs, SITEs, PACKAGE_PINs, IO_BANKs, or PORTs of interest:

```
get_io_standards -of [get_ports ddr4_sdram_dm_n[0]]
```

You can also query the PORT objects that implement a specific IO_STANDARD:

```
get_ports -of [get_io_standards POD12_DCI]
```



TIP: In this case, the ports can also be found by looking at the IOSTANDARD property:

```
get_ports -filter {IOSTANDARD==POD12_DCI}
```

Properties

The properties found on package_pin objects are as follows, with example values:

Property	Type	Read-only	Value
CLASS	string	true	io_standard
DIRECTION	string	true	INPUT OUTPUT BIDIR
DRIVE_STRENGTH	string	true	NA
HAS_VCCO_IN	bool	true	1
HAS_VCCO_OUT	bool	true	1
HAS_VREF	bool	true	1
INPUT_TERMINATION	string	true	SINGLE
IS_DCI	bool	true	1
IS_DIFFERENTIAL	bool	true	0
NAME	string	true	POD12_DCI
OUTPUT_TERMINATION	string	true	DRIVER
SLEW	string	true	SLOW MEDIUM FAST
SUPPORTS_SLEW	bool	true	0
VCCO_IN	double	true	1.200
VCCO_OUT	double	true	1.200
VREF	double	true	0.840

The properties of package_pin objects can be listed with the following command:

```
report_property -all [lindex [get_io_standards] 0]
```

NET

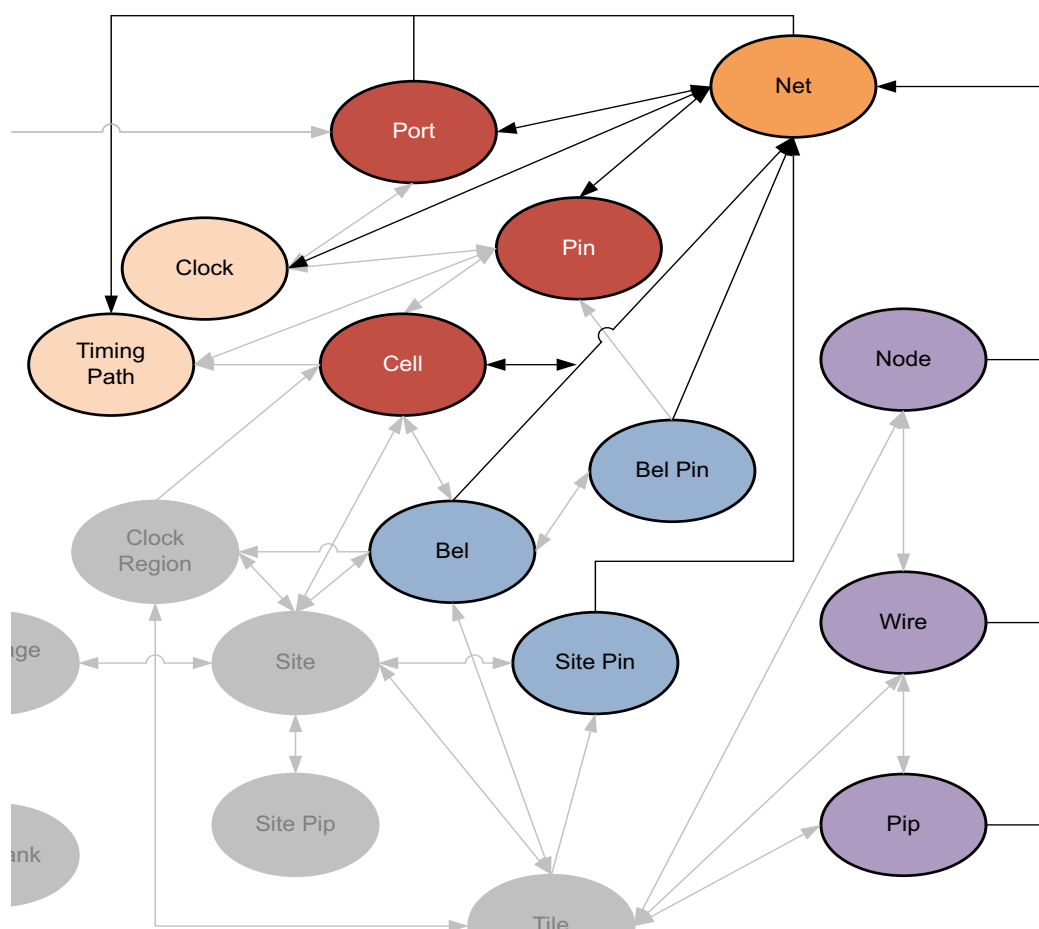

Figure 2-29: NET Objects

Description

A net is a set of interconnected pins, ports, and wires. Every wire has a net name, which identifies it. Two or more wires can have the same net name. All wires sharing a common net name are part of a single NET, and all pins or ports connected to these wires are electrically connected.

A default net name is assigned to the NET object as it is added to the netlist design during elaboration or compilation of the RTL source files into a netlist design. You can also manually assign names to nets.

Nets can either be scalar nets, with a single signal, or can be bus nets, which are groups of scalar nets with multiple signals. Buses are a convenient way to group related signals, allowing a less cluttered, more understandable schematics. It also clarifies the connection between the main circuit and a block symbol. Buses are especially useful for the following:

- Routing a number of signals from one side of the schematic to the other
- Connecting more than one signal to a block symbol
- Connecting more than one signal to pass between hierarchical levels by connecting to a single I/O marker

Related Objects

In the design netlist, a NET can be connected to the PIN of a CELL, or to a PORT. Net objects are also associated with CLOCKS brought onto the design through PORTs, and to TIMING_PATHs in the design. NETs can also be associated with DRC_VIOLATIONS to allow you to more quickly locate and resolve design issues. You can query the nets associated with these different design objects:

```
get_nets -of [get_cells dbg_hub]
```

As the design is mapped onto the target Xilinx FPGA, the NET is mapped to routing resources such as WIRES, NODEs, and PIPs on the device, and is connected to BELs through BEL_PINs, and to SITEs through SITE_PINs. You can query the clock, pin, port, bel, bel_pin, site, site_pin, tile, node, pip, wire associated with a specific net or nets in the design:

```
get_bel_pins -of [get_nets ddr4_sdram_adr[0]]
```

Properties

The specific properties on a net object can vary depending on the type of net the object represents. The following table lists some of the properties assigned to a net object in the Vivado Design Suite, with example values:

Property	Type	Read-only	Visible	Value
AREA_GROUP	string	true	true	
BEL	string	true	true	
BLKNM	string	true	true	
BUFFER_TYPE	enum	false	true	
BUFG	enum	true	true	
BUS_NAME	string	true	true	DataIn_pad_0_i
BUS_START	int	true	true	7
BUS_STOP	int	true	true	0
BUS_WIDTH	int	true	true	8
CLASS	string	true	true	net
CLOCK_BUFFER_TYPE	enum	false	true	
CLOCK_DEDICATED_ROUTE	enum	false	true	
CLOCK_REGION_ASSIGNMENT	string	false	true	
CLOCK_ROOT	string*	false	true	
COLLAPSE	bool	true	true	
COOL_CLK	bool	true	true	
DATA_GATE	bool	true	true	
DCI_VALUE	int	false	true	
DIFF_TERM	bool	false	true	
DIRECT_ENABLE	bool	false	true	
DIRECT_RESET	bool	false	true	
DONT_TOUCH	bool	false	true	

DRIVE	int	true	false	
DRIVER_COUNT	int	true	true	1
ESSENTIAL_CLASSIFICATION_VALUE	int	false	true	
FILE_NAME	string	true	true	
FIXED_ROUTE	string	false	true	
FLAT_PIN_COUNT	int	true	true	1
FLOAT	bool	true	true	
GATED_CLOCK	bool	false	true	
HBLKNM	string	true	true	
HD.NO_ROUTE_CONTAINMENT	bool	false	true	
HIERARCHICALNAME	string	true	false	top.DataIn_pad_0_i[0]
HU_SET	string	true	false	
IBUF_DELAY_VALUE	double	true	true	
IBUF_LOW_PWR	bool	false	true	
IFD_DELAY_VALUE	double	true	true	
IN_TERM	enum	true	true	
IOB	enum	false	true	
IOBDELAY	enum	false	true	
IOSTANDARD	string	true	false	LVCMOS18
IO_BUFFER_TYPE	enum	false	true	
IS_CONTAIN_ROUTING	bool	true	true	0
IS_INTERNAL	bool	true	true	0
IS_REUSED	bool	true	true	0
IS_ROUTE_FIXED	bool	false	true	0
KEEP	bool	true	true	
KEEPER	bool	true	true	
LINE_NUMBER	int	true	true	
LOC	string	true	true	
MARK_DEBUG	bool	false	true	0
MAXDELAY	double	true	true	
MAXSKEW	double	true	true	
MAX_FANOUT	string	false	true	
METHODOLOGY_DRC_VIOS	string	false	true	
MULTI_CLOCK_ROOT	string*	false	true	
NAME	string	true	true	DataIn_pad_0_i[0]
NODELAY	bool	true	true	
NOREDUCE	bool	true	true	
OUT_TERM	enum	true	true	
PARENT	string	true	true	DataIn_pad_0_i[0]
PARENT_CELL	string	true	true	
PIN_COUNT	int	true	true	1
PULLDOWN	bool	true	true	
PULLUP	bool	true	true	
PWR_MODE	enum	true	true	
RAM_STYLE	enum	false	true	
REUSE_STATUS	enum	true	true	
RLOC	string	true	true	
RLOC_ORIGIN	string	true	false	
RLOC_RANGE	string	true	false	
ROM_STYLE	enum	false	true	
ROUTE	string	false	true	
ROUTE_STATUS	enum	true	true	INTRASITE
RPM_GRID	enum	true	true	
RTL_KEEP	string	true	false	
RTL_MAX_FANOUT	string	true	false	
S	bool	true	true	
SCHMITT_TRIGGER	bool	true	true	
SLEW	string	true	true	
SUSPEND	string	true	true	

TYPE	enum	true	true	SIGNAL
USELOWSKEWLINES	bool	true	true	
USE_DSP48	enum	false	true	
U_SET	string	true	false	
WEIGHT	int	false	true	
WIREAND	bool	true	true	
XBLKNM	string	true	true	
XLNX_LINE_COL	int	false	false	
XLNX_LINE_FILE	long	false	false	
_HAVE_MD_DT	bool	true	false	
async_reg	string	false	true	

To report the properties for a net object, you can copy and paste the following command into the Vivado Design Suite Tcl shell or Tcl console:

```
report_property -all [lindex [get_nets] 0]
```

NODE

Description

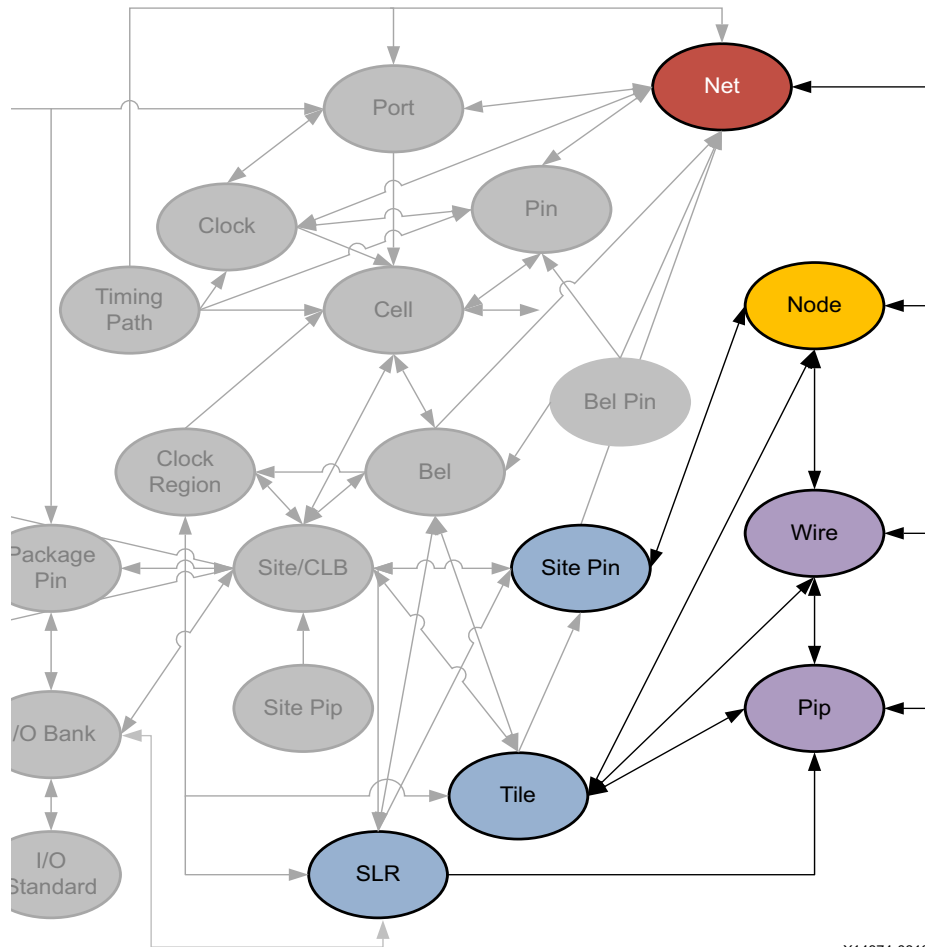

X14874-081315

Figure 2-30: **NODE Objects**

A NODE is a device object used for routing connections, or NETs, on the Xilinx part. It is a collection of WIRES, spanning across multiple tiles, that are physically and electrically connected together. A NODE may connect to a single SITE_PIN, or connect to no pins, serving instead to simply carry NETs into, out of, or across the SITE. A NODE can connect to any number of PIPs, and may also be driven by a tie-off.

Related Objects

As seen in [Figure 2-30, page 110](#), NODE objects are related to SLRs, TILES, NETs, SITE_PINS, WIRES, PIPs, and other NODEs. You can query the NODEs by using a form of the following Tcl command:

```
get_nodes -of_objects [get_nets cpuClk]
```

You can also query the SLRs, and TILES that NODEs are located in, or PIPs, SITE_PINS, SPEED_MODELS, WIRES associated with specific NODEs:

```
get_slrs -of_objects [get_nodes LIOB33_SING_X0Y199/IOB_T_OUT0]
```

Properties

The properties on a NODE object can be reported with a command such as the following:

```
report_property -all [lindex [get_nodes -filter {IS_COMPLETE}] 0]
```



TIP: Due to the number of NODEs on a device, using the `get_nodes Tcl` command without `-of_objects` or `-filters` to narrow the results is not recommended.

The properties include the following, with example values:

Property	Type	Read-only	Value
CLASS	string	true	node
COST_CODE	int	true	14
COST_CODE_NAME	enum	true	OUTBOUND
IS_BAD	bool	true	0
IS_COMPLETE	bool	true	1
IS_GND	bool	true	0
IS_INPUT_PIN	bool	true	0
IS_OUTPUT_PIN	bool	true	0
IS_PIN	bool	true	0
IS_VCC	bool	true	0
NAME	string	true	CLBLL_L_X2Y50/CLBLL_LOGIC_OUTS4
NUM_WIRES	int	true	2
PIN_WIRE	int	true	65535
SPEED_CLASS	int	true	191

PACKAGE_PIN

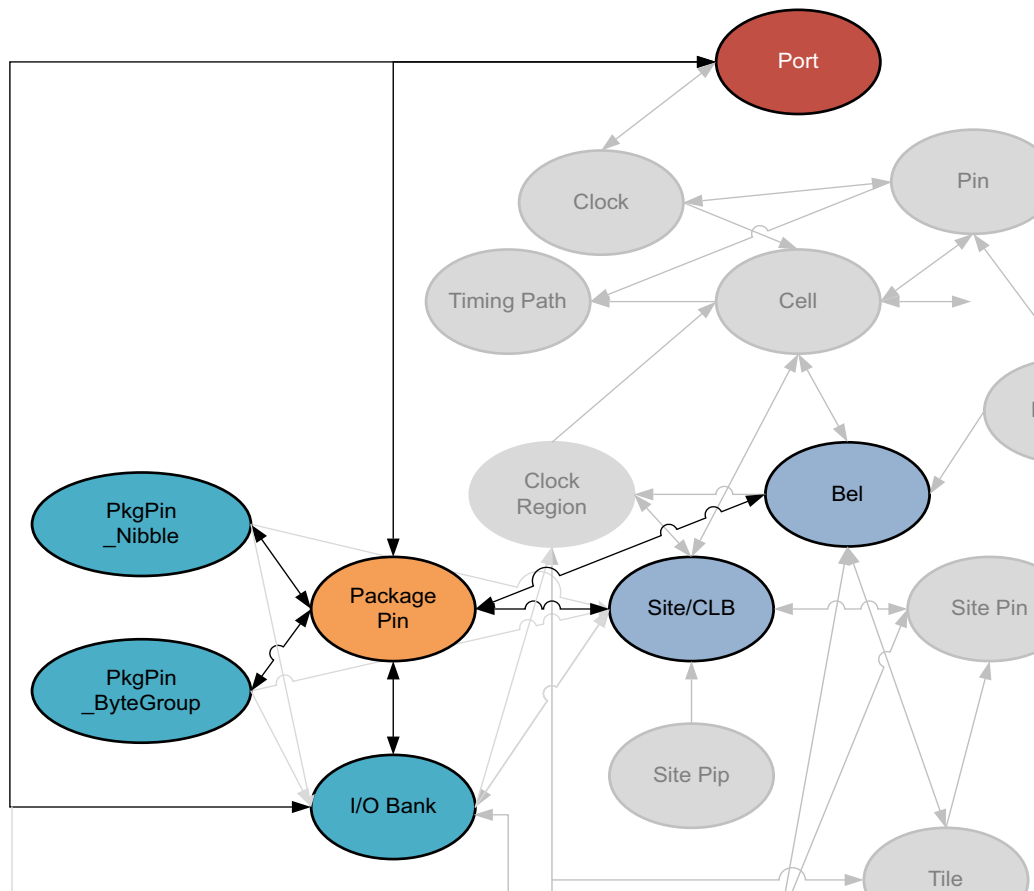

Figure 2-31: PACKAGE_PIN Objects

Description

The PACKAGE_PIN object represents the physical pin on the Xilinx device package that is associated with a specific input or output of the design. The assignment of I/O ports to a package_pin is the subject of the *Vivado Design Suite User Guide: I/O and Clock Planning* (UG899) [Ref 17].

The PACKAGE_PIN object can be assigned to PORT objects through the PACKAGE_PIN property.

Related Objects

PACKAGE_PIN objects are associated with PORT objects in the design netlist, and with SITE, BEL or IO_BANK objects on the target device. In addition, PACKAGE_PIN objects are associated with PKGPIN_BYTEGROUP and PKGPIN_NIBBLE objects. The PACKAGE_PINs can be queried through the use of the following Tcl command:

```
get_package_pins
```

Or, through associated objects with:

```
get_package_pins -of [get_ports]
```

You can also get the port, site, slr, io_bank, io_standard, pkgpin_bytegroup, phkpin_nibble associated with a specified package_pin:

```
get_port -of [get_package_pins AG17]
```



TIP: In this case, the ports can also be found by looking at the [PACKAGE_PIN](#) property:

```
get_ports -filter {PACKAGE_PIN==AG17}
```

Properties

The properties found on package_pin objects are as follows, with example values:

Property	Type	Read-only	Visible	Value
BANK	string	true	true	44
BUFIO_2_REGION	string	true	true	BL
CLASS	string	true	true	package_pin
DIFF_PAIR_PIN	string	true	true	AE21
IS_BONDED	bool	true	true	1
IS_DIFFERENTIAL	bool	true	true	1
IS_GENERAL_PURPOSE	bool	true	true	1
IS_GLOBAL_CLK	bool	true	true	0
IS_LOW_CAP	bool	true	true	0
IS_MASTER	bool	true	true	1
IS_VREF	bool	true	true	0
IS_VRN	bool	true	true	0
IS_VRP	bool	true	true	0
MAX_DELAY	int	true	true	72405
MIN_DELAY	int	true	true	71685
NAME	string	true	true	AD21
PIN_FUNC	enum	true	true	IO_L1P_T0L_N0_DBC_44
PIN_FUNC_COUNT	int	true	true	1

The properties of package_pin objects can be listed with the following command:

```
report_property -all [lindex [get_package_pins] 0]
```

PIN

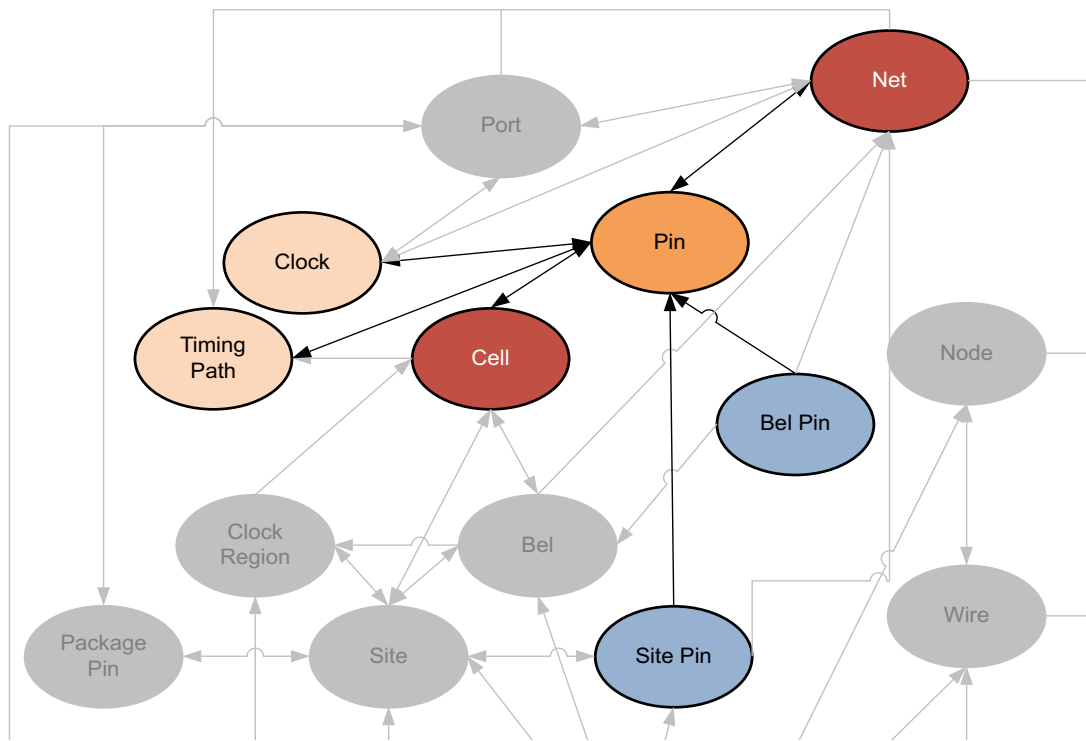

Figure 2-32: PIN Objects

Description

A pin is a point of logical connectivity on a primitive or hierarchical cell. A pin allows the contents of a cell to be abstracted away, and the logic simplified for ease-of-use. Pins can be scalar, containing a single connection, or can be defined as bus pins to group multiple signals together.

Related Objects

A pin is attached to a cell and can be connected to pins on other cells by a net. The pins of cells are also related to the `bel_pins` of the `bel` object, or `site_pins` of a `SITE` that the cell is mapped to. Pins are associated with clocks as part of the clock domain, and are part of `timing_paths` when defined as the start point, end point, or through point of the path.

Pins can also be associated with `drc_violations` to allow you to more quickly locate and resolve design issues.

Properties

The PIN object includes a collection of properties that define the type of pin for clock and control pins. You can use these attributes to filter the list of pins by type when writing Tcl scripts, or working with PIN objects. The properties are listed in the table below.

Table 2-2:

Property Name	Clock Relationship	Description	Example
IS_CLEAR	Asynchronous	Forces block output(s) to a 0 state.	CLR pin in the FDCE
IS_CLOCK	Reference	The pin has a setup/hold or recovery/removal relationship with another pin, and acts as the reference pin in that relationship.	The C pin on an FDRE
IS_ENABLE	Synchronous	Control that allows or inhibits the data capture of a block.	The CE pin on an FDRE
IS_PRESET	Asynchronous	Forces block output(s) to a 1 state.	The PRE pin on an FDPE
IS_RESET	Synchronous	Changes block output(s) to a 0 state at next clock.	The R pin on an FDRE
IS_SET	Synchronous	Changes block output(s) to a 1 state at next clock.	The S pin on an FDSE
IS_SETRESET	Programmable	Programmable synchronous or asynchronous set/reset. The pin's behavior is controlled by an attribute on the block.	The RSTRAMB pin on a RAMB36E2
IS_WRITE_ENABLE	Synchronous	Enable pin that allows or inhibits the write operation on a memory block.	The WES pin on a RAMB36E2

Beyond these properties that define the pin type, the various properties found on PIN objects include the following:

Property	Type	Read-only	Visible	Value
BEL	string	false	true	
BUS_DIRECTION	enum	true	true	
BUS_NAME	string	true	true	
BUS_START	int	true	true	
BUS_STOP	int	true	true	
BUS_WIDTH	int	true	true	
CLASS	string	true	true	pin
CLOCK_DEDICATED_ROUTE	enum	false	true	
DCI_VALUE	int	false	true	
DIRECTION	enum	true	true	IN
ESSENTIAL_CLASSIFICATION_VALUE	int	false	true	
FB_ACTIVE	bool	false	true	
HD.ASSIGNED_PPLOCS	string*	true	true	
HD.CLK_SRC	string	false	true	
HD.LOC_FIXED	bool	false	false	0
HD.PARTPIN_LOCS	string*	false	true	
HD.PARTPIN_RANGE	string*	false	true	
HD.PARTPIN_TIEOFF	bool	false	true	
HD.TANDEM	int	false	true	

HIERARCHICALNAME	string	true	false	
top.cpuEngine.dwb_biu.\retry_cntr_reg[0]	.C			
HOLD_DETOUR	int	false	true	
HOLD_SLACK	double	true	true	needs timing update***
IS_CLEAR	bool	true	true	0
IS_CLOCK	bool	true	true	1
IS_CONNECTED	bool	true	true	1
IS_ENABLE	bool	true	true	0
IS_INVERTED	bool	false	true	0
IS_LEAF	bool	true	true	1
IS_ORIG_PIN	bool	true	true	0
IS_PRESET	bool	true	true	0
IS_RESET	bool	true	true	0
IS_REUSED	bool	true	true	0
IS_SET	bool	true	true	0
IS_SETRESET	bool	true	true	0
IS_WRITE_ENABLE	bool	true	true	0
LOGIC_VALUE	string	true	true	unknown
MARK_DEBUG	bool	false	true	
NAME	string	true	true	
cpuEngine/dwb_biu/retry_cntr_reg[0]/C				
ORIG_PIN_NAME	string	true	true	
PARENT_CELL	cell	true	true	
cpuEngine/dwb_biu/retry_cntr_reg[0]				
REF_NAME	string	true	true	FDCE
REF_PIN_NAME	string	true	true	C
SETUP_SLACK	double	true	true	needs timing update***
TARGET_SITE_PINS	string*	false	true	
XLNX_LINE_COL	int	false	false	
XLNX_LINE_FILE	long	false	false	

The properties of pins can be listed with the following command:

```
report_property -all [lindex [get_pins] 0]
```

PIP or SITE_PIP

Description

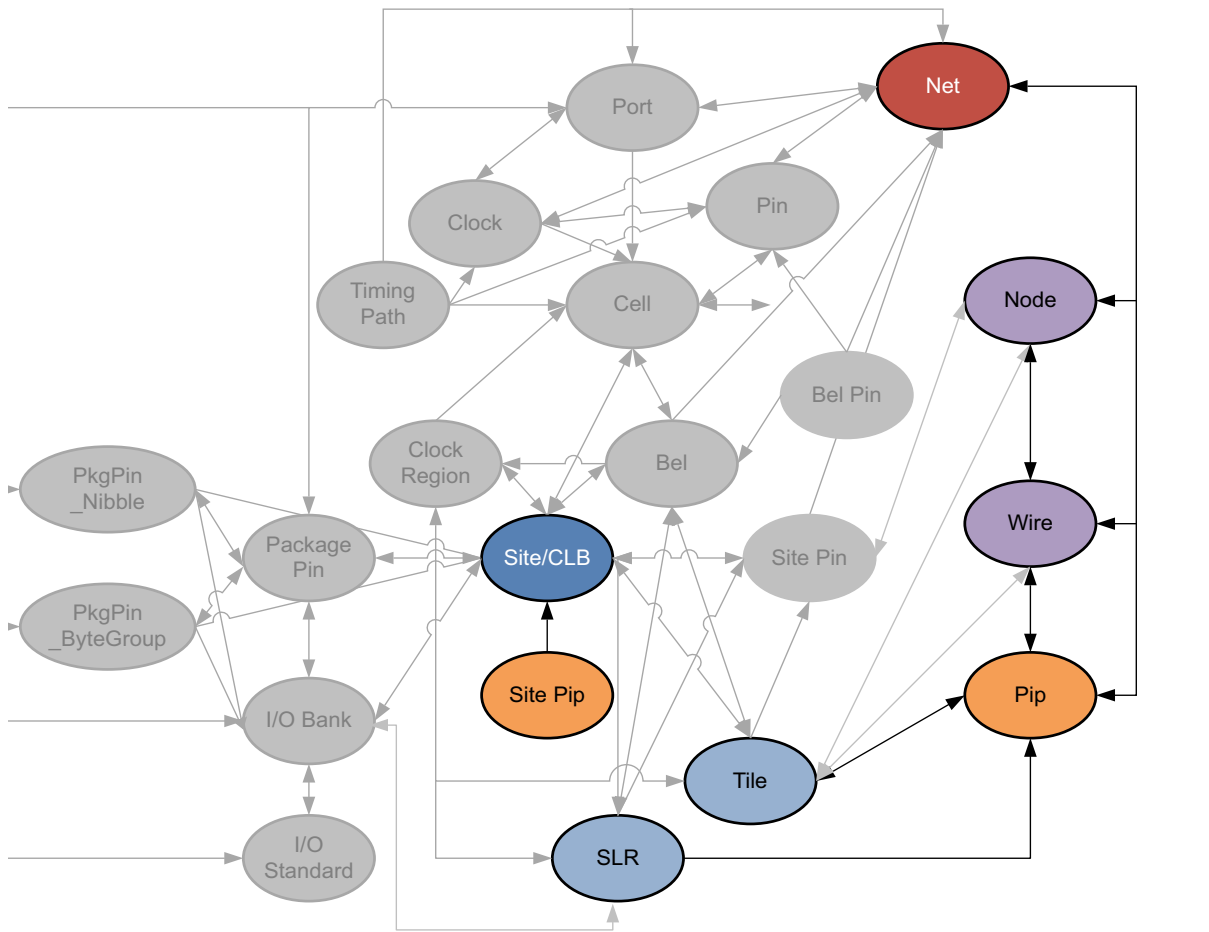

X14877-081315

Figure 2-33: PIP Objects

A PIP is a device object used for routing connections, or NETs, on the Xilinx part. A PIP, also called an ARC, is a connection multiplexer that can be programmed to connect one WIRE to another, thus connecting NODEs together to form the routing required for a specific NET in the design.

A SITE_PIP, also known as a routing BEL, is a connection multiplexer inside a SITE that can connect BEL_PINS to other BEL_PINS, or to SITE_PINS within the SITE.

Related Objects

As seen in [Figure 2-33, page 117](#), PIP objects are related to SLRs, TILES, NODEs, NETs, and WIRES. You can query the PIPs using a form of the following Tcl command:

```
get_pips -of [get_nodes INT_R_X7Y47/NW6BEG1]
```

You can also query the SLRs, and TILES that PIPs are located in; or the NODEs, SPEED_MODELS, or WIRES associated with specific PIPs:

```
get_nodes -of_objects [get_pips INT_R_X7Y47/INT_R.BYP_ALT0->>BYP_BOUNCE0]
```

SITE_PIPs are associated with SITEs:

```
get_site_pips -of [get_sites SLICE_X8Y79]
```

PIP Properties

The properties on a PIP object can be reported with a command such as the following:

```
report_property -all [lindex [get_pips -of [get_tiles INT_R_X7Y47]] 0]
```



TIP: Due to the number of PIPs on a device, using the `get_pips` Tcl command without `-of_objects` or `-filters` to narrow the results is not recommended.

The properties include the following, with example values:

Property	Type	Read-only	Visible	Value
CAN_INVERT	bool	true	true	0
CLASS	string	true	true	pip
IS_BUFFERED_2_0	bool	true	true	0
IS_BUFFERED_2_1	bool	true	true	1
IS_DIRECTIONAL	bool	true	true	1
IS_EXCLUDED_PIP	bool	true	true	0
IS_FIXED_INVERSION	bool	true	true	0
IS_INVERTED	bool	true	true	0
IS_PSEUDO	bool	true	true	0
IS_SITE_PIP	bool	true	true	0
IS_TEST_PIP	bool	true	true	0
NAME	string	true	true	INT_R_X7Y47/INT_R.BYP_ALT0->>BYP_BOUNCE0
SPEED_INDEX	int	true	true	2336
TILE	string	true	true	INT_R_X7Y47
VORPAL_ID	int	true	false	

SITE_PIP Properties

The properties of the SITE_PIP can be reported with the following command:

```
get_site_pips -of [get_sites SLICE_X8Y79]
```

The properties on the SITE_PIP include the following, with example values:

Property	Type	Read-only	Visible	Value
CLASS	string	true	true	site_pip
FROM_PIN	string	true	true	A1
IS_FIXED	bool	true	true	0
IS_USED	bool	true	true	0
NAME	string	true	true	SLICE_X8Y79/D6LUT:A1
SITE	string	true	true	SLICE_X8Y79
TO_PIN	string	true	true	O6

PKGPIN_BYTEGROUP



X14878-081315

Figure 2-34: PKGPIN_BYTEGROUP Objects

Description

For 7 series devices, the hierarchy of I/O banks is divided into two object types: I/O Banks and Package Pins. For Xilinx UltraScale architecture, the I/O bank hierarchy includes two additional divisions: bytegroups and nibbles. The relationships of these objects on an UltraScale device are defined as follows:

- An **IO_BANK** of 52 pins has 4 pkgpin_bytegroups, while a mini IO_BANK of 26 pins has 2 bytegroups.

- Each pkgpin_bytegroup has 13 package pins, and has 2 pkgpin_nibbles, an upper and lower.
- Each pkgpin_nibble has 6 or 7 pins, and is the upper or lower nibble of the pkgpin_bytegroup.
- A package_pin is one pin of an iobank, a pkgpin_bytegroup, or a pkgpin_nibble.

In UltraScale, the bitslice logic connected to I/O banks is grouped into pkgpin_bytegroups and pkgpin_nibbles. These objects aid in the placement of related I/O pins, such as groups of bitslices. For instance, you can use bytegroups and nibbles for I/O pin assignment of memory controllers on UltraScale devices. You can perform interactive I/O planning by opening either the elaborated RTL design or the synthesized design in the Vivado IDE, using the Memory Bank/Byte Planner, which enables automatic or manual assignment of memory I/O pin groups to I/O banks and byte lanes. This process is discussed in detail at this [link](#) in the *Vivado Design Suite User Guide: I/O and Clock Planning* (UG899) [Ref 17].

Related Objects

The PKGPIN_BYTEGROUP and PKGPIN_NIBBLE are related to IO_BANKs, PACKAGE_PINs, and PORTs, as previously described. In addition, each PKGPIN_BYTEGROUP is related to a SITE on the Xilinx device. You can query the PKGPIN_BYTEGROUP of an associated object using a Tcl command like the following:

```
get_pkgpin_bytegroups -of [get_package_pins AG17]
```

You can also get the list of package_pin objects assigned to specific pkgpin_bytegroups:

```
get_package_pins -of [get_pkgpin_bytegroups BANK45_BYTE2]
```

Properties

The properties found on PKGPIN_BYTEGROUP objects are as follows, with example values:

Property	Type	Read-only	Value
CLASS	string	true	pkgpin_bytegroup
INDEX_IN_IOBANK	int	true	2
IOBANK	int	true	45
NAME	string	true	BANK45_BYTE2

The properties of the bytegroup objects can be listed with the following command:

```
report_property -all [lindex [get_pkgpin_bytegroups] 0]
```

PKGPIN_NIBBLE

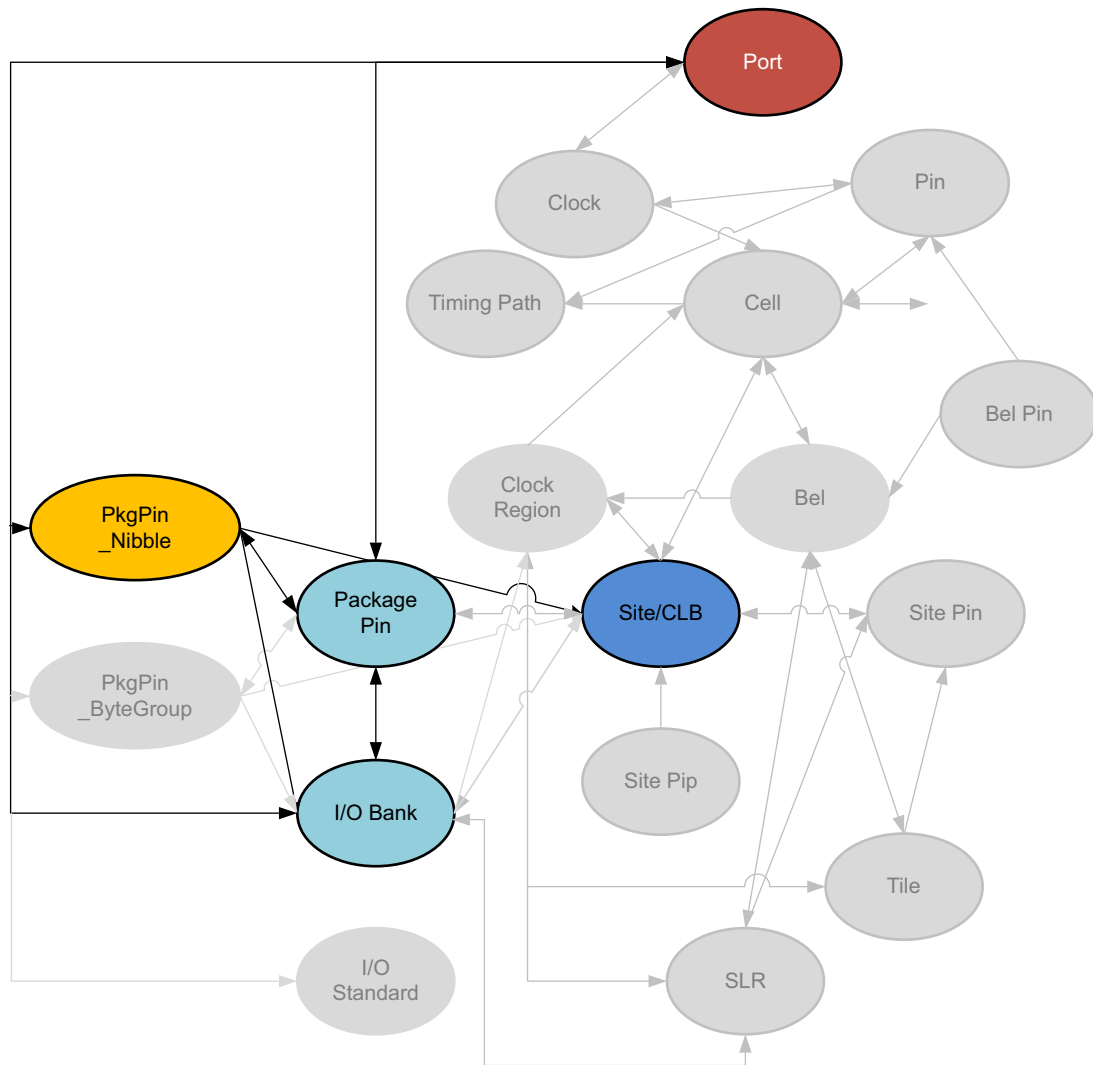

X14680-081315

Figure 2-35: PKGPIN_NIBBLE Objects

Description

The PKGPIN_NIBBLE is a portion of the PKGPIN_BYTEGROUP. Refer to [PKGPIN_BYTEGROUP](#), page 120 for a description of this object.

Related Objects

The PKGPIN_BYTEGROUP and PKGPIN_NIBBLE are related to IO_BANKs, PACKAGE_PINs, and PORTs, as previously described. In addition, each PKGPIN_NIBBLE is related to a SITE on the Xilinx device. You can query the PKGPIN_NIBBLE of an associated object using a Tcl command like the following:

```
get_pkgpin_nibbles -of [get_iobanks 45]
```

You can also get the list of package_pin objects assigned to specific pkgpin_nibbles:

```
get_package_pins -of [get_pkgpin_nibbles BANK45_BYTE2_L]
```

Properties

The properties found on pkgpin_nibble objects are as follows, with example values:

Property	Type	Read-only	Value
CLASS	string	true	pkgpin_nibble
IOBANK	int	true	45
NAME	string	true	BANK45_BYTE2_L
PKGPIN_BYTEGROUP	string	true	BANK45_BYTE2
TYPE	string	true	L

The properties of pkgpin_nibble objects can be listed with the following command:

```
report_property -all [lindex [get_pkgpin_nibbles] 0]
```

Related Objects

Ports at the top level of the design make connection outside the FPGA through the PACKAGE_PINS of the device package, to IO_BANKs on the die, with assigned IOSTANDARDS.

Ports can also carry clock definitions onto the design from the system or board, and should be assigned external system-level path delay using the `set_input_delay` or `set_output_delay` constraints. Refer to the *Vivado Design Suite User Guide: Using Constraints* (UG903) [Ref 19] for more information on these constraints.

You can query the ports assigned to specific package_pins, IO_banks, IO_Standards, sites, cells, nets, clocks, timing_paths, or drc_violations using a Tcl command like the following:

```
get_ports -of [get_clocks]
```

Inside the design, ports are connected to cells, through nets, to build the hierarchical netlist. You can query the objects associated with a port, such as net, timing_path, site, io_bank, io_standard, package_pin, pkgpin_bytegroup, pkgpin_nibble, using the following form of command:

```
get_package_pins -of [all_inputs]
```

Properties

The properties found on ports objects are as follows, with example values:

Property	Type	Read-only	Visible	Value
BOARD_PART_PIN	string	false	true	
BOARD_PIN	string	false	false	
BUFFER_TYPE	enum	false	true	
BUS_DIRECTION	enum	true	true	
BUS_NAME	string	true	true	
BUS_START	int	true	true	
BUS_STOP	int	true	true	
BUS_WIDTH	int	true	true	
CLASS	string	true	true	port
CLOCK_BUFFER_TYPE	enum	false	true	
DIFFTERMTYPE	bool	false	false	0
DIFF_PAIR_PORT	string	true	true	
DIFF_PAIR_TYPE	enum	true	true	
DIFF_TERM	bool	false	true	0
DIRECTION	enum	false	true	IN
DQS_BIAS	enum	false	true	
DRIVE	enum	false	true	12
DRIVE_STRENGTH	enum	false	false	12
ESSENTIAL_CLASSIFICATION_VALUE	int	false	true	
HD.ASSIGNED_PPLOCS	string*	true	true	
HD.CLK_SRC	string	false	true	
HD.LOC_FIXED	bool	false	false	0
HD.PARTPIN_LOCS	string*	false	true	
HD.PARTPIN_RANGE	string*	false	true	
HD.PARTPIN_TIEOFF	bool	false	true	

HOLD_SLACK	double	true	true	needs timing update***
IBUF_LOW_PWR	bool	false	true	0
INTERFACE	string	false	true	
INTERMTYPE	enum	false	false	NONE
IN_TERM	enum	false	true	NONE
IOB	enum	false	true	
IOBANK	int	true	true	33
IOSTANDARD	enum	false	true	LVCOS18
IOSTD	enum	false	false	LVCOS18
IO_BUFFER_TYPE	enum	false	true	
IS_BEL_FIXED	bool	false	false	1
IS_FIXED	bool	false	false	1
IS_GT_TERM	bool	true	true	0
IS_LOC_FIXED	bool	false	true	1
IS_REUSED	bool	true	true	
KEEP	string	false	true	
KEEPER	bool	false	false	0
LOAD	double	false	true	
LOC	site	false	true	IOB_X1Y43
LOGIC_VALUE	string	true	true	unknown
NAME	string	false	true	reset
OFFCHIP_TERM	string	false	true	NONE
OUT_TERM	enum	false	true	
PACKAGE_PIN	package_pin	false	true	W9
PIN_TYPE	enum	true	false	
PIO_DIRECTION	enum	false	true	
PULLDOWN	bool	false	false	0
PULLTYPE	string	false	true	
PULLUP	bool	false	false	0
SETUP_SLACK	double	true	true	needs timing update***
SITE	site	false	false	IOB_X1Y43
SLEW	enum	false	true	
SLEWTYPE	enum	false	false	
SLEW_ADV	enum	false	false	
UNCONNECTED	bool	true	true	0
USE_INTERNAL_VREF	enum	false	true	
VCCAUX_IO	enum	false	true	
XLNX_LINE_COL	int	false	false	
XLNX_LINE_FILE	long	false	false	
X_INTERFACE_INFO	string	false	true	

The properties of ports can be listed with the following command:

```
report_property -all [lindex [get_ports] 0]
```

SITE

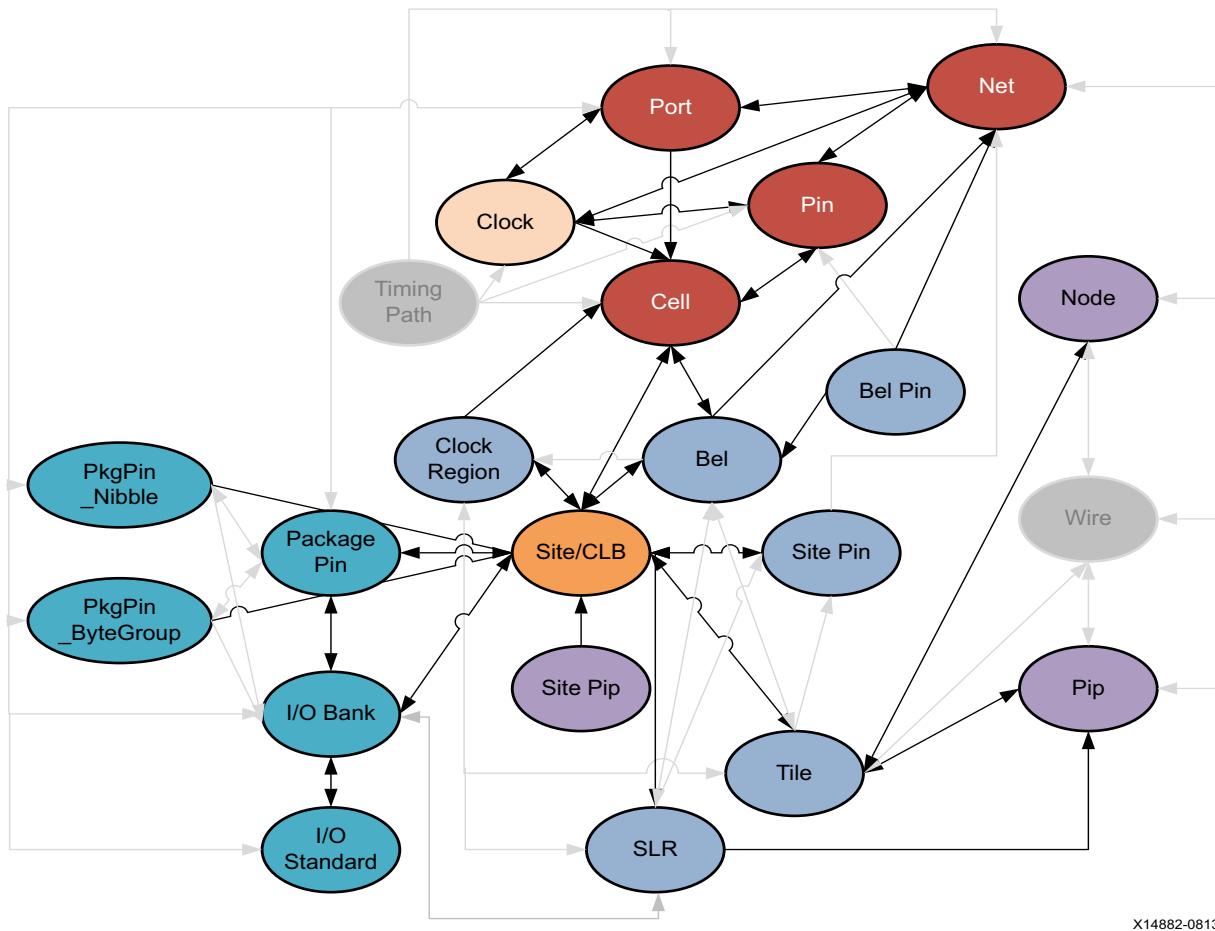

X14882-081315

Figure 2-37: SITE Objects

Description

A SITE is a device object representing one of many different types of logic resources available on the target Xilinx FPGA.

SITEs include SLICE/CLBs which are collections of basic logic elements (BELs) like look-up-tables (LUTs), flip-flops, muxes, carry logic resources to implement fast addition, subtraction, or comparison operations. SLICE/CLBs have wide multiplexers, and dedicated carry chains running vertically from SLICE to SLICE.

There are two types of SLICES in a device:

- SLICEMs can be configured to act as distributed RAM. Distributed Memory is a configuration feature of certain LUTs so it behaves as a small 64-bit memory.
- SLICEL LUTs can only function as logic and not memory.

Two SLICES are grouped together into a configurable logic block (CLB) in 7 series FPGAs. Two CLBs are grouped together into one TILE object on the device. Each UltraScale architecture CLB contains one SLICE. See the *7 Series FPGAs Configurable Logic Block User Guide* (UG474) [Ref 4] or *UltraScale Architecture Configurable Logic Block User Guide* (UG574) [Ref 10] for more information.

SITEs also contain varied device resources such as block RAM, DSPs, I/O blocks, Clock resources, and GT blocks.

You utilize device resources by inference from the HDL source by Vivado synthesis, or by instantiating a primitive or macro from the FPGA library, or an IP core from the Vivado IP catalog. The *Vivado Design Suite 7 Series FPGA and Zynq-7000 SoC Libraries Guide* (UG953) [Ref 25] and *UltraScale Architecture Libraries Guide* (UG974) [Ref 26] describe the list of primitives that can be instantiated.

The available SITE types vary depending on the Xilinx device in use. Some of the SITE types include:

```
AMS_ADC AMS_DAC
BSCAN BSCAN_JTAG_MONE2
BUFG BUFGCTRL BUFG_LB BUFGHCE
BUFIO BUFMRCE BUFR
CAPTURE
DCIRESET DNA_PORT
DRP_AMS_ADC DRP_AMS_DAC
DSP48E1
EFUSE_USR
FIFO18E1 FIFO36E1
FRAME_ECC
GLOBALSIG
GTHE2_CHANNEL GTHE2_COMMON
GTPE2_CHANNEL GTPE2_COMMON
GTXE2_CHANNEL GTXE2_COMMON
GTZE2_OCTAL
IBUFDS_GTE2 ICAP
IDELAYCTRL IDELAYE2 IDELAYE2_FINEDELAY
ILOGICE2 ILOGICE3
IN_FIFO
IOB IOB18 IOB18M IOB18S
IOB33 IOB33M IOB33S
IOBM IOBS
IPAD ISERDESE2
KEY_CLEAR
MMCME2_ADV
ODELAYE2 ODELAYE2_FINEDELAY
OLOGICE2 OLOGICE3
OPAD
```

```

OSERDESE2
OUT_FIFO
PCIE_2_1 PCIE_3_0
PHASER_IN PHASER_IN_ADV PHASER_IN_PHY
PHASER_OUT PHASER_OUT_ADV PHASER_OUT_PHY
PHASER_REF
PHY_CONTROL
PLLE2_ADV PMV2
RAMB18E1 RAMB36E1 RAMBFIFO36E1
SLICEL SLICEM
STARTUP TIEOFF
USR_ACCESS
XADC
    
```

Related Objects

As seen in [Figure 2-37, page 127](#), SITES are related to many different netlist and device objects. Leaf-CELLs like flops and latches are mapped to BELs which are in turn mapped to SITES like SLICEL and SLICEM, or are mapped directly to SITES such as BRAMs and DSPs. BELs and SITES are grouped into TILES, and are assigned to CLOCK_REGIONs and SLRs on the device. PORTs, PINs, IO_BANKs, and PACKAGE_PINs relate to IO blocks (IOBs) which are also SITES. SITES also have pins, or SITE_PINs, that map to NODEs, PIPs, PINs, and NETs. You can query the sites associated with any of these objects as follows:

```
get_sites -of [get_cells -hier microblaze_0]
```

You can also use the SITE to query associated objects such as CELL, PORT, BEL, BEL_PIN, CLOCK_REGION, SITE_PIN, SLR, TILE, IO_BANK, IO_STANDARD, PACKAGE_PIN, PKGPIN_BYTEGROUP, PKGPIN_NIBBLE, PIP, and SITE_PIP. For example:

```
get_clock_regions -of [get_sites DSP48E2_X2Y119]
```

Properties

There are over 80 different SITE types on Xilinx FPGA devices, but they all share the following properties, with example values provided:

Property	Type	Read-only	Visible	Value
ALTERNATE_SITE_TYPES	string	true	true	IOB33S IOB33M
CLASS	string	true	true	site
CLOCK_REGION	string	true	true	X0Y6
IS_BONDED	bool	true	true	1
IS_CLOCK_BUFFER	bool	true	true	0
IS_CLOCK_PAD	bool	true	true	0
IS_GLOBAL_CLOCK_BUFFER	bool	true	true	0
IS_GLOBAL_CLOCK_PAD	bool	true	true	0
IS_PAD	bool	true	true	1
IS_REGIONAL_CLOCK_BUFFER	bool	true	true	0
IS_REGIONAL_CLOCK_PAD	bool	true	true	0
IS_RESERVED	bool	true	true	0
IS_TEST	bool	true	true	0
IS_USED	bool	true	true	0
MANUAL_ROUTING	string	false	true	

NAME	string	true	true	IOB_X0Y349
NUM_ARCS	int	true	true	9
NUM_BELS	int	true	true	7
NUM_INPUTS	int	true	true	12
NUM_OUTPUTS	int	true	true	5
NUM_PINS	int	true	true	17
PRIMITIVE_COUNT	int	true	true	0
PROHIBIT	bool	false	true	0
PROHIBIT_FROM_PERSIST	bool	true	true	0
RPM_X	int	true	true	1
RPM_Y	int	true	true	698
SITE_PIPS	string	false	true	
SITE_TYPE	enum	true	true	IOB33

The properties assigned to SITE objects are the same for all SITE_TYPES. To report the properties for any of the SITE_TYPES listed above, you can use the `report_property` command:

```
report_property -all [lindex [get_sites -filter {SITE_TYPE == <SITE_TYPE>}] 0]
```

Where `<SITE_TYPE>` should be replaced by one of the listed SITE types. For example:

```
report_property -all [lindex [get_sites -filter {SITE_TYPE == DSP48E1}] 0]
report_property -all [lindex [get_sites -filter {SITE_TYPE == RAMB36E1}] 0]
report_property -all [lindex [get_sites -filter {SITE_TYPE == IBUFDS_GTE2}] 0]
```

SLR

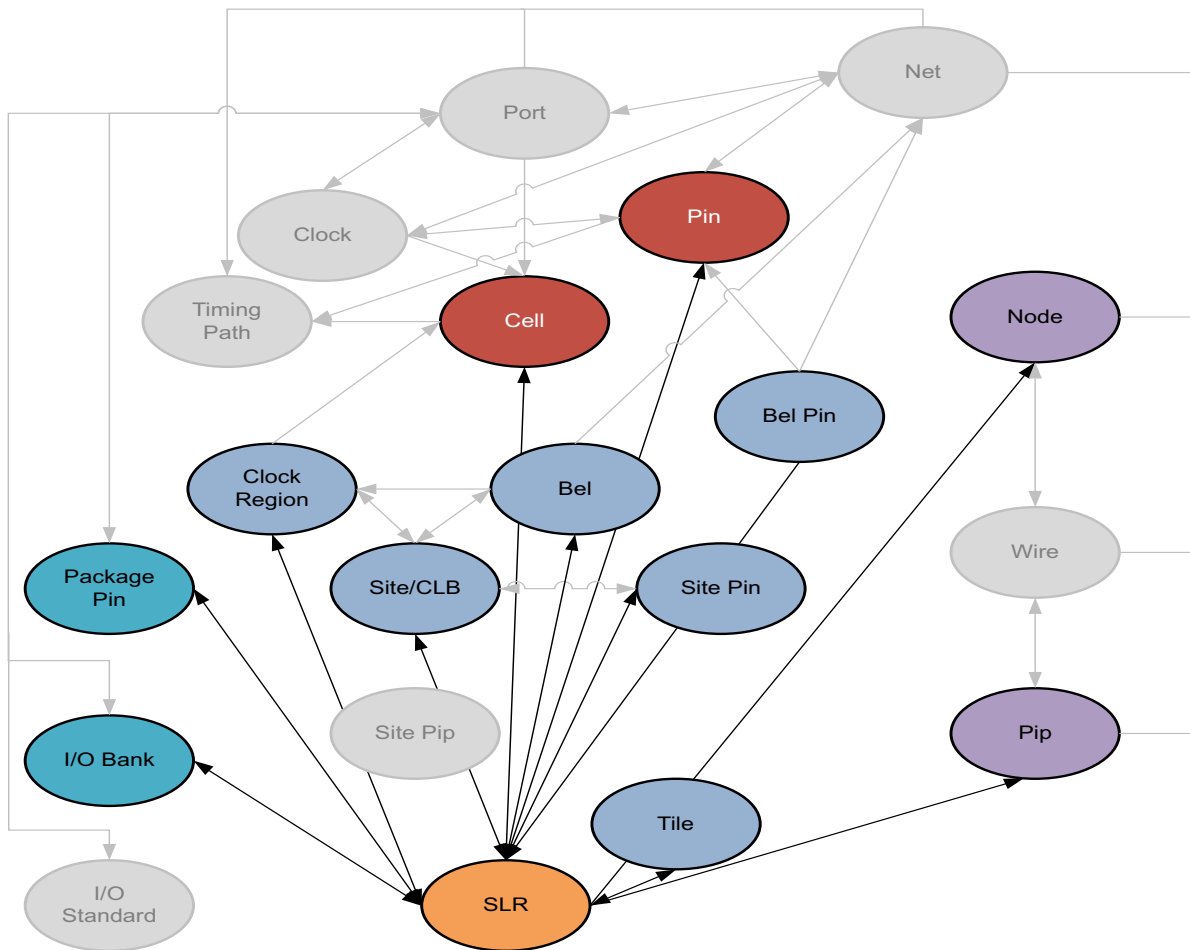

X14884-081315

Figure 2-38: SLR Objects

Description

A Super Logic Region (SLR) is a single FPGA die slice contained in an stacked silicon interconnect (SSI) device. Stacked silicon interconnect (SSI) technology uses passive silicon interposers with microbumps and through-silicon vias (TSVs) to combine multiple FPGA die slices, referred to as super logic regions (SLRs), into a single package.

Each SLR contains the active circuitry common to most Xilinx FPGA devices, and are connected through super long lines (SLLs) found on the silicon interposers. Refer to this [link](#) in the *UltraFast Design Methodology Guide for the Vivado Design Suite* (UG949) [Ref 24] for more information on working with SSI components.

Related Objects

Super logic regions (SLRs) are die slices of Xilinx FPGA architecture or devices. As shown in [Figure 2-38, page 131](#), each SLR contains clock regions, tiles, sites, site pins, bels, bel pins, nodes, pips, cells, pins, I/O banks, and package pins. You can find the SLRs associated with each of these different types of objects, with a Tcl command such as the following, that returns the SLR that the specified cell is assigned to:

```
get_slrs -of [get_cells DataIn_pad_0_i_IBUF[3]_inst]
```

You can also query the clock regions, tiles, sites, or bels associated with an SLR. The following Tcl command gets I/O banks of the clock regions associated with a specific SLR:

```
get_iobanks -of [get_clock_regions -of [get_slrs SLR3]]
```

Properties

You can use the `report_property` command to report the properties of an SLR. Refer to the *Vivado Design Suite Tcl Command Reference Guide* (UG835) [\[Ref 13\]](#) for more information. The properties on the SLR object include the following, with example values:

Property	Type	Read-only	Visible	Value
ARCH	string	true	true	virtex7
CHIP_TYPE	string	true	true	xc7vx1140t 0
CLASS	string	true	true	slr
CONFIG_ORDER_INDEX	int	true	true	0
IS_FABRIC	bool	true	true	1
IS_MASTER	bool	true	true	1
LOWER_RIGHT_CORNER	int	true	true	(0,157)
LOWER_RIGHT_X	int	true	true	0
LOWER_RIGHT_Y	int	true	true	157
MAX_SITE_INDEX	int	true	true	278381
MAX_TILE_INDEX	int	true	true	266114
MIN_SITE_INDEX	int	true	true	185588
MIN_TILE_INDEX	int	true	true	177410
NAME	string	true	true	SLR1
NUM_CHANNELS	int	true	true	220
NUM_SITES	int	true	true	92794
NUM_SLLS	int	true	true	10780
NUM_TILES	int	true	true	23169
NUM_TOP_CLOCK_CONNECTIONS	int	true	true	32
NUM_TOP_DATA_CONNECTIONS	int	true	true	10780
SLR_INDEX	int	true	true	1
UPPER_LEFT_CORNER	int	true	true	(564,313)
UPPER_LEFT_X	int	true	true	564
UPPER_LEFT_Y	int	true	true	313

To report the properties for a specific SLR, you can copy and paste the following command into the Vivado Design Suite Tcl shell or Tcl console:

```
report_property -all [get_slrs <name>]
```

Where `<name>` is the name of the SLR to report.

TILE

Description

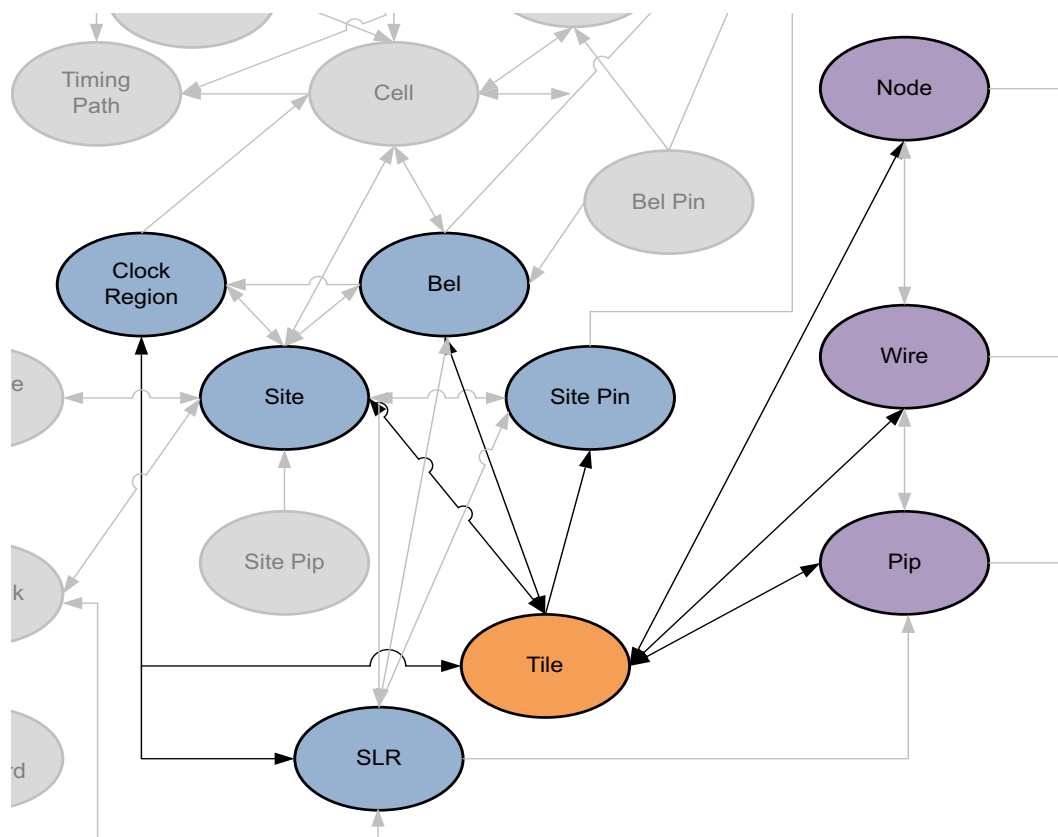

X14885-081315

Figure 2-39: TILE Objects

A TILE is a device object containing one or more **SITE** objects. Programmable logic TILES include diverse objects such as SLICE/CLBs, BRAM, DSPs, I/O Blocks, Clock resources, and GT blocks. Structurally, each tile has a number of inputs and outputs and the programmable interconnect to connect the inputs and outputs of a tile to any other tile.

There are many different types of TILES, depending on the Xilinx device in use. Available TILE_TYPES include the following:

```
AMS_ADC_TOP AMS_BRAM
AMS_CLB_INTF_IOB AMS_CLK AMS_CMT
AMS_DAC_TOP AMS_DRP_ADC_TOP AMS_DRP_DAC_TOP
AMS_DSP AMS_INT AMS_INT_L AMS_INT_R
AMS_IOI AMS_VBRK_INTF
BRAM_INT_INTERFACE_L BRAM_INT_INTERFACE_R
BRAM_L BRAM_R
BRKH_BRAM BRKH_B_TERM_INT
BRKH_CLB BRKH_CLK BRKH_CMT
```

```

BRKH_DSP_L BRKH_DSP_R BRKH_GTX
BRKH_INT BRKH_TERM_INT B_TERM_INT B_TERM_INT_SLV
CFG_CENTER_BOT CFG_CENTER_MID CFG_CENTER_MID_SLAVE
CFG_CENTER_TOP CFG_CENTER_TOP_SLAVE
CLBLL_L CLBLL_R CLBLL_L CLBLL_R
CLK_BALI_REBUF CLK_BALI_REBUF_GTZ_BOT CLK_BALI_REBUF_GTZ_TOP
CLK_BUF_G BOT_R CLK_BUF_REBUF CLK_BUF_TOP_R
CLK_FEED
CLK_HROW_BOT_R CLK_HROW_TOP_R
CLK_MTB2
CLK_PMV CLK_PMV2 CLK_PMV2_SVT CLK_PMVIOB
CLK_TERM
CMT_FIFO_L CMT_FIFO_R
CMT_PMV CMT_PMV_L
CMT_TOP_L LOWER_B CMT_TOP_L LOWER_T
CMT_TOP_L_UPPER_B CMT_TOP_L_UPPER_T
CMT_TOP_R_LOWER_B CMT_TOP_R_LOWER_T
CMT_TOP_R_UPPER_B CMT_TOP_R_UPPER_T
DSP_L DSP_R
GTH_CHANNEL_0 GTH_CHANNEL_1 GTH_CHANNEL_2 GTH_CHANNEL_3 GTH_COMMON
GTH_INT_INTERFACE GTH_INT_INTERFACE_L
GTX_CHANNEL_0 GTX_CHANNEL_1 GTX_CHANNEL_2 GTX_CHANNEL_3 GTX_COMMON
GTX_INT_INTERFACE GTX_INT_INTERFACE_L
GTZ_BOT GTZ_BRAM
GTZ_CLB_INTF_IOB GTZ_CLK GTZ_CLK_B GTZ_CMT
GTZ_DSP
GTZ_INT GTZ_INT_L GTZ_INT_LB GTZ_INT_R GTZ_INT_RB
GTZ_IOI GTZ_TOP GTZ_VBRK_INTF
HCLK_BRAM HCLK_CLB
HCLK_CMT HCLK_CMT_L
HCLK_DSP_L HCLK_DSP_R
HCLK_FEEDTHRU_1 HCLK_FEEDTHRU_2
HCLK_FIFO_L
HCLK_GTX
HCLK_INT_INTERFACE HCLK_IOB
HCLK_IOI HCLK_IOI3
HCLK_L HCLK_L_BOT_UTURN HCLK_L_SLV HCLK_L_TOP_UTURN
HCLK_R HCLK_R_BOT_UTURN HCLK_R_SLV HCLK_R_TOP_UTURN
HCLK_TERM HCLK_TERM_GTX HCLK_VBRK HCLK_VFRAME
INT_FEEDTHRU_1 INT_FEEDTHRU_2
INT_INTERFACE_L INT_INTERFACE_R
INT_L INT_L_SLV INT_L_SLV_FLY
INT_R INT_R_SLV INT_R_SLV_FLY
IO_INT_INTERFACE_L IO_INT_INTERFACE_R
LIOB18 LIOB18_SING LIOB33 LIOB33_SING
LIOI LIOI3 LIOI3_SING LIOI3_TBYTESRC LIOI3_TBYTETERM
LIOI_SING LIOI_TBYTESRC LIOI_TBYTETERM
L_TERM_INT L_TERM_INT_BRAM
MONITOR_BOT MONITOR_BOT_SLAVE MONITOR_MID MONITOR_TOP
NULL
PCIE3_BOT_RIGHT PCIE3_INT_INTERFACE_L PCIE3_INT_INTERFACE_R
PCIE3_RIGHT PCIE3_TOP_RIGHT PCIE_BOT
PCIE_BOT_LEFT PCIE_INT_INTERFACE_L PCIE_INT_INTERFACE_LEFT_L
PCIE_INT_INTERFACE_R
PCIE_NULL PCIE_TOP PCIE_TOP_LEFT
RIOB18 RIOB18_SING RIOI RIOI_SING
RIOI_TBYTESRC RIOI_TBYTETERM
R_TERM_INT R_TERM_INT_GTX
TERM_CMT
    
```

```
T_TERM_INT T_TERM_INT_SLV
VBRK VBRK_EXT
VFRAME
```

Related Objects

TILE objects are associated with SLR, CLOCK_REGION, SITE, SITE_PIN, BEL and BEL_PIN device resources, with NODE, WIRE, and PIP routing resources, and with the NET netlist object.

For example, you can query the TILE of a related object using the following command, which returns the tiles the specified net travels through:

```
get_tiles -of_objects [get_nets wbClk]
```

In addition, you can query the SLR, CLOCK_REGION, NODE, PIP, WIRE, SITE, BEL, and NET objects associated with or found in a TILE.

```
get_bels -of_objects [get_tiles -filter {TILE_TYPE == GTX_CHANNEL_1}]
```

Properties

Although there are many different types of TILE objects, as represented by the TILE_TYPE property, all TILE objects have the same set of properties.

You can use the `report_property` command to report the properties of a TILE object. Refer to the *Vivado Design Suite Tcl Command Reference Guide* (UG835) [Ref 13] for more information.

The properties on a CLBLL type of TILE object include the following, with example values:

Property	Type	Read-only	Visible	Value
CLASS	string	true	true	tile
COLUMN	int	true	true	50
DEVICE_ID	int	true	true	0
FIRST_SITE_ID	int	true	true	46
GRID_POINT_X	int	true	true	50
GRID_POINT_Y	int	true	true	1
INDEX	int	true	true	167
INT_TILE_X	int	true	true	17
INT_TILE_Y	int	true	true	0
IS_CENTER_TILE	bool	true	true	1
IS_DCM_TILE	bool	true	true	0
IS_GT_CLOCK_SITE_TILE	bool	true	true	0
IS_GT_SITE_TILE	bool	true	true	0
NAME	string	true	true	CLBLL_L_X18Y199
NUM_ARCS	int	true	true	146
NUM_SITES	int	true	true	2
ROW	int	true	true	1
SLR_REGION_ID	int	true	true	0
TILE_PATTERN_IDX	int	true	true	13
TILE_TYPE	enum	true	true	CLBLL_L
TILE_TYPE_INDEX	int	true	true	19

TILE_X	int	true	true	-16260
TILE_Y	int	true	true	320944
TYPE	string	true	true	CLBLL_L

To report the properties for any of the TILE_TYPES listed previously, you can use the following form of the `report_property` command:

```
report_property -all [lindex [get_sites -filter {TILE_TYPE == <TILE_TYPE>}] 0]
```

Where `<SITE_TYPE>` should be replaced by one of the listed SITE types. For example:

```
report_property -all [lindex [get_tiles -filter {TILE_TYPE == DSP_L}] 0]
report_property -all [lindex [get_tiles -filter {TILE_TYPE == BRAM_L}] 0]
report_property -all [lindex [get_tiles -filter {TILE_TYPE == GTX_CHANNEL_1}] 0]
```

TIMING_PATH

Description

Timing paths are defined by connections between elements of the design. In digital designs, timing paths are formed by a pair of sequential elements controlled by the same clock, or by two different clocks to launch and capture the signal.

In a typical timing path, the data is transferred between two sequential cells within one clock period. For example, the launch edge occurs at time 0 ns; and the capture edge occurs one **CLOCK** period later.

The most common timing paths are:

- Paths from an input port to a internal sequential cell
- Internal paths from one sequential cell to another sequential cell
- Paths from an internal sequential cell to an output port
- Paths from an input port to an output port

Each timing path is defined by unique startpoints, throughpoints, and endpoints. A path startpoint is a sequential cell clock pin or a data input port; and a path endpoint is a sequential cell data input pin or a data output port.

TIMING_PATH objects can be selected or specified with varying degrees of details. A single unique timing path is defined by a combination of startpoint, throughpoint, and endpoint. Multiple timing paths can be specified from a common startpoint, or a common endpoint.

Constraints can be applied to timing paths as determined by the definition of the timing path. The order of precedence for constraints applied to timing paths, from highest to lowest, is as follows:

1. -from -through -to (*a unique timing path*)
2. -from -to
3. -from -through
4. -from
5. -through -to
6. -to
7. -through (*any timing path passing through this point*)

For more information on timing paths refer to *Vivado Design Suite User Guide: Design Analysis and Closure Techniques* (UG906) [Ref 22].

Related Objects

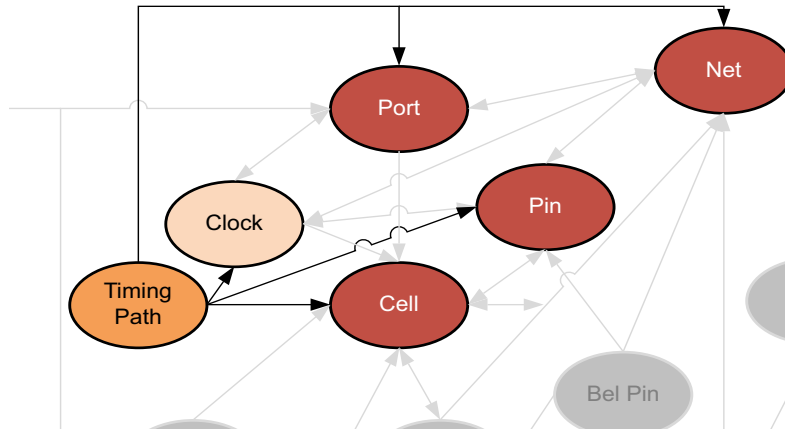

Figure 2-40: TIMING_PATH Objects

TIMING_PATH objects can be queried using the `get_timing_paths` command. This allows you to specify timing paths using related CLOCK, PIN, PORT, or CELL objects to identify startpoints, throughpoints, or endpoints on the paths of interest.

```
get_timing_paths -from fftEngine/control_reg_reg[1] -max_paths 10
```

In addition, you can query the CELL, NET, PIN, or PORT objects associated with specified timing paths:

```
get_nets -of_objects [get_timing_paths -max_paths 10]
```

Properties

The properties on a TIMING_PATH object include the following, with example values:

Property	Type	Read-only	Visible	Value
CLASS	string	true	true	timing_path
CLOCK_PESSIMISM	double	true	true	-0.661
CORNER	string	true	true	Slow
DATAPATH_DELAY	double	true	true	6.934
DELAY_TYPE	string	true	true	max
ENDPOINT_CLOCK	clock	true	true	cpuClk_3
ENDPOINT_CLOCK_DELAY	double	true	true	-2.149
ENDPOINT_CLOCK_EDGE	double	true	true	20.000
ENDPOINT_PIN	pin	true	true	
cpuEngine/or1200_immu_top/qmemimmu_cycstb_o_reg/D				
EXCEPTION	string	true	true	
GROUP	string	true	true	cpuClk_3
INPUT_DELAY	double	true	true	
INTER_SLR_COMPENSATION	double	true	true	
LOGIC_LEVELS	int	true	true	16
NAME	string	true	true	{usbEngine0/u4/inta_reg/C -->
cpuEngine/or1200_immu_top/qmemimmu_cycstb_o_reg/D				
OUTPUT_DELAY	double	true	true	
REQUIREMENT	double	true	true	10.000

SKEW	double	true	true	-0.057
SLACK	double	true	true	2.865
STARTPOINT_CLOCK	clock	true	true	usbClk_2
STARTPOINT_CLOCK_DELAY	double	true	true	-2.754
STARTPOINT_CLOCK_EDGE	double	true	true	10.000
STARTPOINT_PIN	pin	true	true	usbEngine0/u4/inta_reg/C
UNCERTAINTY	double	true	true	0.202
USER_UNCERTAINTY	double	true	true	

The properties of TIMING_PATH objects can be reported with the following command:

```
report_property -all [lindex [get_timing_paths] 0]
```

WIRE

Description

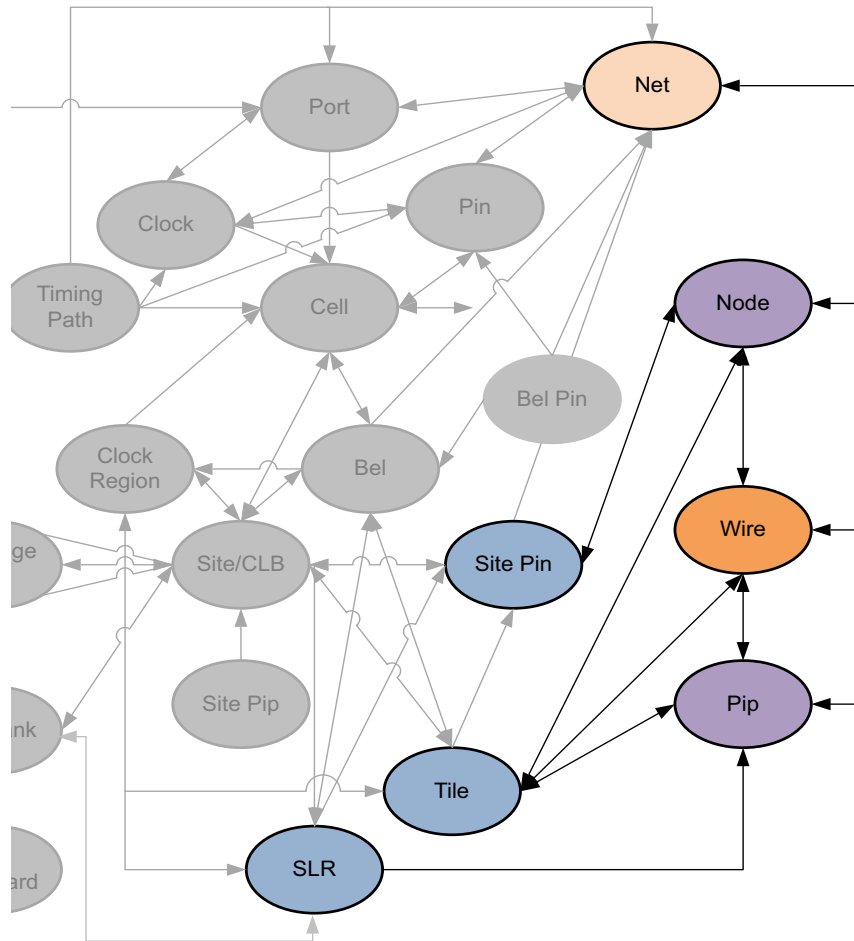

X14887-081315

Figure 2-41: WIRE Objects

A WIRE is a device object used for routing connections, or NETs, on the Xilinx part. A WIRE is a strip of interconnect metal inside a single tile. Wires connect between PIPs, tie-offs, and SITE_PINS.



TIP: The WIRE object should not be confused with the wire entity in the Verilog files of a design. Those wires are related to NETs in the design rather than the routing resources of the device which are defined by the WIRE object.

Related Objects

As seen in [Figure 2-33, page 117](#), WIRE objects are related to TILES, NODEs, PIPs, or NETs. You can query WIRES using a form of the following Tcl command:

```
get_wires -of [get_tiles INT_R_X7Y47]
```

You can also query the TILES that WIRES are located in; or the NODEs and PIPs associated with specific WIRES:

```
get_nodes -of_objects [get_wires INT_R_X7Y47/NW6BEG1]
```

Properties

The properties on a WIRE object can be reported with a command such as the following:

```
report_property -all [lindex [get_wires -of [get_nodes INT_R_X7Y47/NW6BEG1]] 0]
```



TIP: Due to the number of WIRES on a device, using the `get_wires` Tcl command without `-of_objects` or `-filters` to narrow the results is not recommended.

The properties include the following, with example values:

Property	Type	Read-only	Visible	Value
CLASS	string	true	true	wire
COST_CODE	int	true	true	3
ID_IN_TILE_TYPE	int	true	true	123
IS_CONNECTED	bool	true	true	1
IS_INPUT_PIN	bool	true	true	0
IS_OUTPUT_PIN	bool	true	true	0
IS_PART_OF_BUS	bool	true	true	0
NAME	string	true	true	INT_R_X7Y47/NW6BEG1
NUM_DOWNHILL_PIPS	int	true	true	0
NUM_INTERSECTS	int	true	true	1
NUM_PIPS	int	true	true	20
NUM_TILE_PORTS	int	true	true	0
NUM_UPHILL_PIPS	int	true	true	20
SPEED_INDEX	int	true	true	2232
TILE_NAME	string	true	true	INT_R_X7Y47
TILE_PATTERN_OFFSET	int	true	true	0

Key Property Descriptions

Properties Information

This chapter provides information about Xilinx® Vivado® Design Suite properties. The entry for each property contains the following information, where applicable:

- A **Description** of the property, including its primary uses.
- The Xilinx FPGA **Architectures** supporting the property, including UltraScale™ architecture devices, except where specifically noted.
- The **Applicable Objects** or device resources supporting the property.
- Possible **Values** that can be assigned to the property.
- **Syntax** specifications, including **Verilog**, **VHDL**, and **XDC** where applicable.
- **Affected Steps** in the design flow where the property has influence.
- **See Also** cross references to related properties.



IMPORTANT: *When a property is defined in both HDL code and as a constraint in the XDC file, the XDC property takes precedence and overrides the HDL property.*

For more information on the use of these properties within the Vivado Design Suite, refer to the *Vivado Design Suite User Guide: Using Constraints* (UG903) [Ref 19].

ASYNC_REG



IMPORTANT: If `ASYNC_REG` and `IOB` are both assigned to a register, the `IOB` property takes precedence over `ASYNC_REG` and the register is placed in an `ILOGIC` block rather than into `SLICE/CLB` logic.

`ASYNC_REG` is an attribute that affects many processes in the Vivado tools flow. `ASYNC_REG` specifies that:

- A register can receive asynchronous data on the D input pin relative to its source clock.
- A register is a synchronizing register within a synchronization chain.

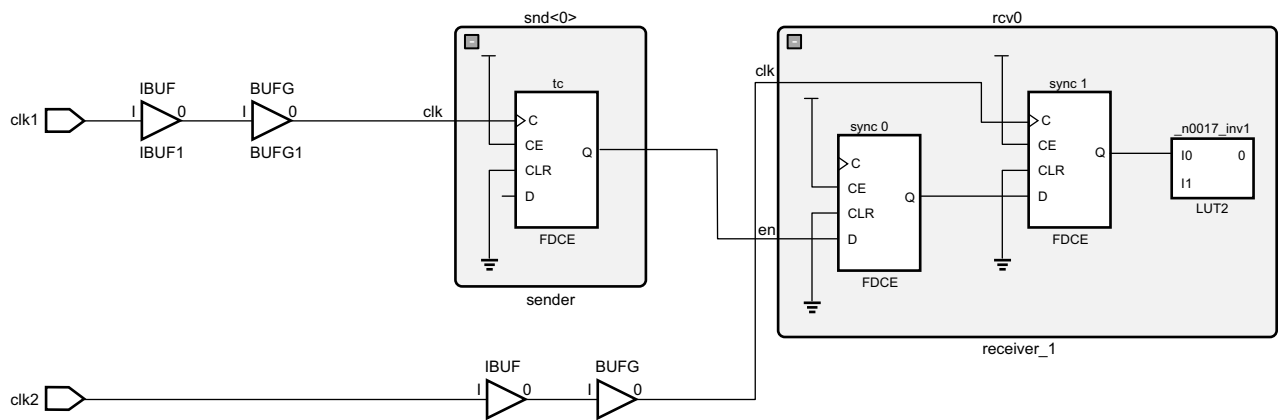

Figure 3-1: Synchronizing Clock Domains

During simulation, when a timing violation occurs, the default behavior is for a register element to output an 'X', or unknown state (not a 1 or 0). When this happens, anything that element drives will see an 'X' on its input and in turn enters an unknown state. This condition can propagate through the design, in some cases causing large sections of the design to become unknown, and sometimes the simulator can not recover from this state. `ASYNC_REG` modifies the register to output the last known value even though a timing violation occurs.

Vivado synthesis treats the `ASYNC_REG` property like the `DONT_TOUCH` property, and pushes it forward in the synthesized netlist. This ensures that synthesis will not optimize registers or surrounding logic, and that downstream tools in the design flow receive the `ASYNC_REG` property for processing.

Specifying `ASYNC_REG` also affects optimization, placement, and routing to improve mean time between failure (MTBF) for registers that may go metastable. If `ASYNC_REG` is applied, the placer will ensure the flip-flops on a synchronization chain are placed closely together in order to maximize MTBF. Registers that have this property that are directly connected will be grouped and placed together into a single `SLICE/CLB`, assuming they have a compatible

control set and the number of registers does not exceed the available resources of the SLICE/CLB.



TIP: For UltraScale devices, mean time between failures (MTBF) can be reported for synchronizing registers identified with `ASYNC_REG` using the `report_synchronizer_mtbf` command.

The following is a Verilog example of a two FF, or one-stage synchronizer, as shown in Figure 3-1. The registers synchronize a signal from a separate clock domain. The `ASYNC_REG` property is attached to synchronizing stages with a value of `TRUE`:

```
(* ASYNC_REG = "TRUE" *) reg sync_0, sync_1;
always @(posedge clk) begin
sync_1 <= sync_0;
sync_0 <= en;
. . .
```



TIP: The `ASYNC_REG` property can also be used with SystemVerilog logic syntax:

```
(* ASYNC_REG = "TRUE" *) logic sync_0, sync_1;
-or-
(* ASYNC_REG = "TRUE" *) output logic sync_0, sync_1,
```

With the `ASYNC_REG` property, the registers are grouped so that they are placed as closely together as possible.

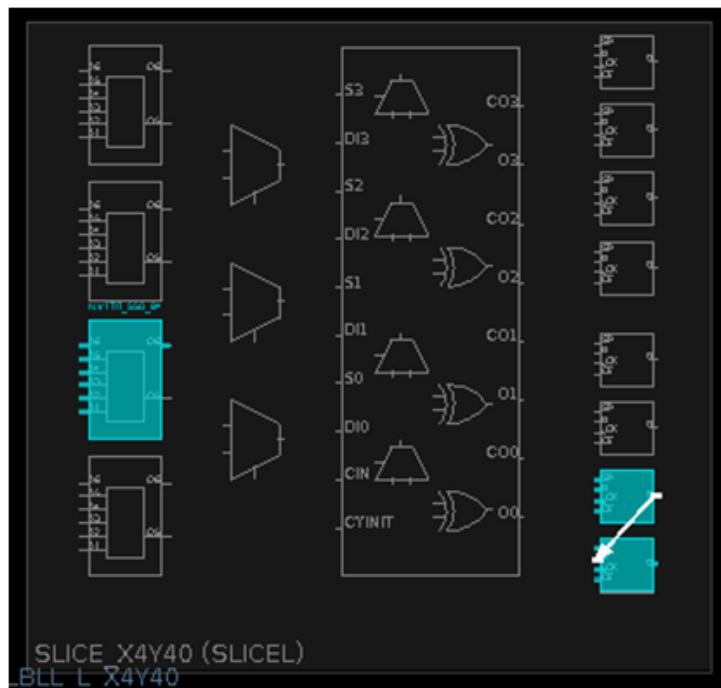

Figure 3-2: Grouping Registers

Architecture Support

All architectures.

Applicable Objects

- Signals declared in the source RTL
- Instantiated register cells (`get_cells`)
 - Registers (FD, FDCE, FDPE, FDRE, FDSE)

Values

- **TRUE:** The register is part of a synchronization chain. It will be preserved through implementation, placed near the other registers in the chain and used for MTBF reporting.
- **FALSE:** The register can be optimized away, or absorbed into a block such as SRL, DSP, or RAMB. No special simulation, placement, or routing rules will be applied to it (default).

Syntax

Verilog Syntax

Place the Verilog attribute immediately before the instantiation or reg declaration of a register:

```
(* ASYNC_REG = "{TRUE|FALSE}" *)
```

Verilog Syntax Example

```
// Designates sync_regs as receiving asynchronous data
(* ASYNC_REG = "TRUE" *) reg [2:0] sync_regs;
```

VHDL Syntax

Declare and specify the VHDL attribute as follows for inferred logic:

```
attribute ASYNC_REG : string;
attribute ASYNC_REG of name: signal is "TRUE";
```

Or, specify the VHDL attribute as follows for instantiated logic:

```
attribute ASYNC_REG of name: label is "TRUE";
```

Where `name` is:

- The declared signal that will be inferred to a synchronizer register, or

- The instance name of an instantiated register

VHDL Syntax Example

```
attribute ASYNC_REG : string;  
signal sync_regs : std_logic_vector(2 downto 1);  
-- Designates sync_regs as receiving asynchronous data  
attribute ASYNC_REG of sync_regs: signal is "TRUE";
```

XDC Syntax

```
set_property ASYNC_REG value [get_cells <instance_name>]
```

Where

- <instance_name> is a register cell.

XDC Syntax Example

```
# Designates sync_regs as receiving asynchronous data  
set_property ASYNC_REG TRUE [get_cells sync_regs*]
```

Affected Steps

- launch_xsim
- synth_design
- place_design
- route_design
- phys_opt_design
- power_opt_design
- report_drc
- write_verilog
- write_vhdl

See Also

[IOB, page 243](#)

AUTO_INCREMENTAL_CHECKPOINT

The `AUTO_INCREMENTAL_CHECKPOINT` property is a boolean property that enables or disables the automatic incremental implementation flow, to reuse the placement and routing from an earlier iteration of the current design. This property works with the `INCREMENTAL_CHECKPOINT` property to manage incremental implementation in the Vivado tools. Refer to this [link](#) in the *Vivado Design Suite User Guide: Implementation* (UG904) [Ref 20] for more information.



TIP: The `AUTO_INCREMENTAL_CHECKPOINT` property is only supported in the Vivado tools project-mode. To reuse prior placement and routing results in non-project mode use the `read_checkpoint -incremental` command.

The incremental implementation flow can be configured in one of three ways:

- Automatic reuse of the prior placement and routing of the current design. Enable the `AUTO_INCREMENTAL_CHECKPOINT` property.
- Manual reuse of the placement and routing data from a prior implementation of a specified design checkpoint. Disable the `AUTO_INCREMENTAL_CHECKPOINT` property, and specify the `INCREMENTAL_CHECKPOINT` property.
- Disabled so there is no incremental implementation. Disable the `AUTO_INCREMENTAL_CHECKPOINT` property, and do not specify the `INCREMENTAL_CHECKPOINT` property.

Architecture Support

All architectures.

Applicable Objects

- Vivado implementation run objects (`get_runs`)

Values

- **1:** Enables the automatic incremental implementation design flow. This lets the Vivado placement and routing tools reuse the placement and routing from prior implementations of the current design, to speed processing of the design.
- **0:** Disables the automatic incremental implementation design flow. This is the default setting.

Syntax

Verilog and VHDL Syntax

Not applicable

XDC Syntax

```
set_property AUTO_INCREMENTAL_CHECKPOINT 1 [get_runs <impl_run> \  
-filter {IS_IMPLEMENTATION}]
```

Where:

- <impl_run> is the name of an implementation run in the current design or project.



TIP: You can use the `-filter {IS_IMPLEMENTATION}` option for the `get_runs` command to get just implementation runs.

XDC Syntax Example

```
set_property AUTO_INCREMENTAL_CHECKPOINT 1 [get_runs * -filter {IS_IMPLEMENTATION}]
```

Affected Steps

- Implementation

See Also

[INCREMENTAL_CHECKPOINT](#), page 237

BEL

BEL specifies the placement of a leaf-level Cell within a SLICE/CLB, or other site which may contain multiple cells. BEL is typically used with an associated [LOC](#) property to specify the exact placement of a register or LUT.



IMPORTANT: *The BEL property or constraint must be defined prior to the LOC property or constraint, or a placement error may be returned.*

Architecture Support

All architectures.

Applicable Objects

- Cells (`get_cells`)
 - Register (FD, FDCE, FDPE, FDRE, FDSE)
 - LUT (LUT1, LUT2, LUT3, LUT4, LUT5, LUT6, LUT6_2)
 - SRL (SRL16E, SRLC32E)
 - LUTRAM (RAM32X1S, RAM64X1S)
 - Configuration Components (BSCAN, ICAP, etc.)

Values

- BEL = <name>

BEL names can take many different forms depending on the specific logic contents of the BEL. BEL names can also hierarchically include the SITE name for the BEL. For instance, some valid BEL names are BSCAN_X0Y0/BSCAN, and SLICE_X1Y199/A5FF.

Syntax

Verilog Syntax

Place the Verilog attribute immediately before the instantiation. The Verilog attribute can also be placed before the `reg` declaration of an inferred register, SRL, or LUTRAM.

```
(* BEL = "site_name" *)
```

Verilog Syntax Example

```
// Designates placed_reg to be placed in FF site A5FF
(* BEL = "A5FF" *) reg placed_reg;VHDL Syntax
```

Declare the VHDL attribute as follows:

```
attribute BEL : string;
```

For an instantiated instance, specify the VHDL attribute as follows:

```
attribute BEL of instance_name : label is "site_name";
```

Where

- `instance_name` is the instance name of an instantiated register, LUT, SRL, or LUTRAM.

VHDL Syntax Example

```
-- Designates instantiated register instance placed_reg to be placed in FF site A5FF
attribute BEL of placed_reg : label is "A5FF";
```

For an inferred instance, specify the VHDL attribute as follows:

```
attribute BEL of signal_name : signal is "site_name";
```

Where

- `signal_name` is the signal name of an inferred register, LUT, SRL, or LUTRAM.

VHDL Syntax Example

```
-- Designates instantiated register instance placed_reg to be placed in FF site A5FF
attribute BEL of placed_reg : signal is "A5FF";
```

XDC Syntax

```
set_property BEL site_name [get_cells instance_name]
```

Where

- `instance_name` is a register, LUT, SRL, or LUTRAM, or other cell instance.

XDC Syntax Example

```
# Designates placed_reg to be placed in FF site A5FF
set_property BEL A5FF [get_cells placed_reg]
```

Affected Steps

- Design Floorplanning
- `place_design`

See Also

[LOC, page 268](#)

BLACK_BOX

The BLACK_BOX attribute is a useful debugging attribute that can turn a whole level of hierarchy off and enable synthesis to create a black box for that module or entity. When the attribute is found, even if there is valid logic for a module or entity, Vivado synthesis creates a black box for that level. This attribute can be placed on a module, entity, or component.



IMPORTANT: *Because this attribute affects the synthesis compiler, it can only be set in the RTL.*

For more information regarding coding style for Black Boxes, refer to this [link](#) in the *Vivado Design Suite User Guide: Synthesis* (UG901) [Ref 18].

Architecture Support

- All architectures.

Applicable Objects

- Modules, entities, or components in the source RTL.

Values

- **YES | TRUE:** Specifies that the module or entity should be viewed as a black box and not expanded as part of the elaborated or synthesized design.



IMPORTANT: *To disable the black box feature, remove the BLACK_BOX attribute from the RTL module or entity. Do not simply set the attribute to NO or FALSE.*

Syntax

Verilog Syntax

In Verilog, the BLACK_BOX attribute on the module does not require a value. Its presence defines a black box.

```
(* black_box *) module test(in1, in2, clk, out1);
```

VHDL Syntax

```
attribute black_box : string;  
attribute black_box of beh : architecture is "yes";
```

XDC Syntax

Not Applicable

Affected Steps

- Synthesis

BLOCK_SYNTH

The BLOCK_SYNTH property lets you assign synthesis properties to an instance of a hierarchical module in the design, to provide a greater degree of control over global synthesis. With BLOCK_SYNTH you can specify different optimizations for two different instances of the same module, and process them during global synthesis.

By setting a BLOCK_SYNTH on an instance, you will be affecting that instance and everything below it. For example, if a hierarchical module has other modules nested within it, those modules are also affected by the BLOCK_SYNTH property. However, you can also assign another BLOCK_SYNTH property to the nested module to change its settings, or restore it to the default value.

When working with IP, you can use the BLOCK_SYNTH property when the IP is specified for global synthesis.



IMPORTANT: *If the IP is specified for out-of-context (OOC) synthesis, the BLOCK_SYNTH property is ignored.*

You can use the block-level synthesis strategy to synthesize different levels of hierarchy with different synthesis options in a top-down flow. You can specify constraints for the full design, and also specify unique constraints for specific instances of hierarchical modules. For more information on block-level synthesis, refer to this [link](#) in the *Vivado Design Suite User Guide: Synthesis* (UG901) [Ref 18].

Architecture Support

- All architectures.

Applicable Objects

- Hierarchical modules (`get_cells`)



IMPORTANT: *Set the property on a cell instance, and not on an entity or module name.*

Values

- **BLOCK_SYNTH.<option_name>**: Indicates that the module instance should be synthesized with the specified parameters or options. The list of options that can be specified can be found in the *Vivado Design Suite User Guide: Synthesis* (UG901) [Ref 18].

Syntax

Verilog and VHDL Syntax

Not applicable

XDC Syntax

Set the BLOCK_SYNTH property in the XDC file using the following syntax:

```
set_property BLOCK_SYNTH.<option_name> <value> [get_cells <instance_name>]
```

Where:

- <option_name> specifies the option to be defined.
- <value> specifies the value of the option.
- <instance_name> specifies the instance name of an hierarchical cell, block, or IP, to apply the property to.

For example, you can define the following in an XDC file:

```
set_property BLOCK_SYNTH.RETIMING 1 [get_cells U1]  
set_property BLOCK_SYNTH.STRATEGY {AREA_OPTIMIZED} [get_cells U2]  
set_property BLOCK_SYNTH.STRATEGY {AREA_OPTIMIZED} [get_cells U3]  
set_property BLOCK_SYNTH.STRATEGY {DEFAULT} [get_cells U3/inst1]
```

Affected Steps

- Synthesis

BUFFER_TYPE



IMPORTANT: *This property has been deprecated, and is replaced by the [CLOCK_BUFFER_TYPE](#) and [IO_BUFFER_TYPE](#) properties.*

CARRY_REMAP

The `opt_design -carry_remap` option lets you remap single CARRY* cells into LUTs to improve the routing results of the design. When using the `-carry_remap` option, only single-stage carry chains are converted to LUTs. The CARRY_REMAP property lets you specify carry chains of greater length to be converted during optimization.

You can control the conversion of individual carry chains of any length by using the CARRY_REMAP cell property. The CARRY_REMAP property value is an integer that specifies the maximum carry chain length to be mapped to LUTs. The CARRY_REMAP property is applied to CARRY* primitives within a chain, and each cell must have the same value to be converted to LUTs during optimization.



IMPORTANT: Each CARRY cell in a carry chain must have the same CARRY_REMAP value. If at least one of the cascaded cells cannot be remapped due to presence of the `DONT_TOUCH` property, then the entire chain cannot be remapped. A warning will be issued when this occurs.

Refer to the *Vivado Design Suite User Guide: Implementation* (UG904) [Ref 20] for more information on optimization.

Architecture Support

- All architectures.

Applicable Objects

- CARRY Cells (`get_cells`)

Value

- `<VALUE>`: Specify an integer value that indicates the length of the carry chain that can be converted to LUTs during `opt_design`.
 - CARRY_REMAP=0: Do not remap.
 - CARRY_REMAP=1: Remap single CARRY cells that are not part of a carry chain.
 - CARRY_REMAP=2: Remap carry chain with length of 2 or less.

Syntax

Verilog and VHDL Syntax

Not applicable

XDC Syntax

```
set_property CARRY_REMAP <value> <objects>
```

XDC Syntax Example

The following assigns a CARRY_REMAP property to all CARRY8 primitives:

```
set_property CARRY_REMAP 2 [get_cells -hier -filter {ref_name == CARRY8}]
```

Affected Steps

- Logic Optimization (opt_design)

See Also

[DONT_TOUCH](#), page 197

[LUT_REMAP](#), page 281

[MUXF_REMAP](#), page 290

CASCADE_HEIGHT

The CASCADE_HEIGHT attribute is an integer used to describe the length of the cascade chains of large RAMS that are put into block RAMs. When a RAM that is larger than a single block RAM is described, the Vivado synthesis tool determines how it must be configured.

Often, the tool chooses to cascade the block RAMs that it creates. This attribute can be used to shorten or limit the length of the chain. A value of 0 or 1 for this attribute effectively turns off any cascading of block RAMs.

This attribute can be placed on the RAM in question in the RTL source files, or in an XDC file, to drive synthesis.

Architecture Support

- UltraScale architecture.

Applicable Objects

- RAM Cells (`get_cells`)

Values

- `<VALUE>`: Specify an integer.

Syntax

Verilog Syntax

```
(* cascade_height = 4 *) reg [31:0] ram [(2**15) - 1:0];
```

VHDL Syntax

```
attribute cascade_height : integer;  
attribute cascade_height of ram : signal is 4;
```

XDC Syntax

```
set_property CASCADE_HEIGHT 4 [get_cells my_RAM_reg]
```

Affected Steps

- Synthesis

CELL_BLOAT_FACTOR

The CELL_BLOAT_FACTOR property lets you specify the addition of “whitespace” or increased cell spacing to increase placement distance between the cells of a hierarchical module. The Vivado placer will space out the cells in the module to improve routing results of the design.

You can use cell bloating, when the placement of cells from a module is close together and causing congestion, to insert whitespace during the placement step. This leads to a lower density of cells in a given area of the die, which can reduce congestion by increasing available routing resources. This technique is particularly effective in small, congested areas of relatively high-performance logic.



TIP: *The unused logic between cells of a module can be used by the Vivado placer for other cells that are not contained in the hierarchical module.*

To use cell bloating, apply the CELL_BLOAT_FACTOR property to hierarchical cells and set the value to LOW, MEDIUM, or HIGH.

HIGH is the recommended setting when working with smaller modules of several hundred cells. Using cell bloating on larger modules might force the placed cells of the module to be too far apart.



IMPORTANT: *If the device already uses too many routing resources, cell bloating is not recommended.*

Architecture Support

- All architectures.

Applicable Objects

- Cells (`get_cells`)

Value

- **LOW | MEDIUM | HIGH:** Specifies the relative spacing between the cells of an hierarchical module.

Syntax

Verilog and VHDL Syntax

Not applicable

XDC Syntax

```
set_property CELL_BLOAT_FACTOR <value> <objects>
```

XDC Syntax Example

The following assigns a CELL_BLOAT_FACTOR property to the cpuEngine module:

```
set_property CELL_BLOAT_FACTOR high [get_cells { cpuEngine }]
```

Affected Steps

- Placement (`place_design`)
- Routing (`route_design`)

See Also

CFGBVS

Xilinx devices support configuration interfaces with 3.3V, 2.5V, 1.8V, or 1.5V I/O. The configuration interfaces include the JTAG pins in bank 0, the dedicated configuration pins in bank 0, and the pins related to specific configuration modes in bank 14 and bank 15 in 7 series devices, and bank 65 in the UltraScale architecture.

To support the appropriate configuration interface voltage on bank 0, the Configuration Bank Voltage Select pin (CFGBVS) must be set to VCCO_0 or GND in order to configure I/O Bank 0 for either 3.3V/2.5V or 1.8V/1.5V operation respectively. The CFGBVS is a logic input pin referenced between VCCO_0 and GND. When the CFGBVS pin is connected to the VCCO_0 supply, the I/O on bank 0 support operation at 3.3V or 2.5V during configuration. When the CFGBVS pin is connected to GND, the I/O in bank 0 support operation at 1.8V or 1.5V during configuration.

The CFGBVS pin setting determines the I/O voltage support for bank 0 at all times. For 7 series devices in which bank 14 and bank 15 are the HR bank type, or bank 65 in UltraScale architecture, the CFGBVS pin and the respective [CONFIG_VOLTAGE](#) property determine the I/O voltage support during configuration.



IMPORTANT: *When the CFGBVS pin is set to GND for 1.8V/1.5V I/O operation, the VCCO_0 supply and I/O signals to Bank 0 must be 1.8V (or lower) to avoid damage to the Xilinx FPGA.*

Refer to the *7 Series FPGAs Configuration User Guide* (UG470) [Ref 1], or the *UltraScale Architecture Configuration User Guide* (UG570) [Ref 7] for more information on Configuration Bank Voltage Select.

The Report DRC command checks the CFGBVS and CONFIG_VOLTAGE properties to determine the compatibility of CONFIG_MODE setting on the current design.

Architecture Support

All architectures.

Applicable Objects

- Designs (`current_design`)

Values

- **VCCO:** Configure I/O Bank 0 for 3.3V/2.5V operation.
- **GND:** Configure I/O Bank 0 for 1.8V/1.5V operation.

Syntax

Verilog and VHDL Syntax

Not applicable

XDC Syntax

```
set_property CFGBVS [VCCO | GND] [current_design]
```

XDC Syntax Example

```
# Configure I/O Bank 0 for 3.3V/2.5V operation  
set_property CFGBVS VCCO [current_design]
```

Affected Steps

- I/O Planning
- Report DRC
- write_bitstream

See Also

[CONFIG_MODE](#), page 177

[CONFIG_VOLTAGE](#), page 179

CLOCK_BUFFER_TYPE

By default, Vivado synthesis infers an input buffer and global clock buffer (IBUF/BUFG) combination for clocks ports. However, you can use the [IO_BUFFER_TYPE](#) and the [CLOCK_BUFFER_TYPE](#) properties together to direct the Vivado synthesis tool to change the default buffer types, such as an IBUF/BUFR pair, or no input buffer with a BUFIO clock buffer; or to eliminate the buffers altogether.

The [CLOCK_BUFFER_TYPE](#) property indicates what type of clock buffer to infer for the specified net or port objects. The [IO_BUFFER_TYPE](#) property indicates whether to infer an input or output buffer for the port.



TIP: The use of the [CLOCK_BUFFER_TYPE](#) property implies a *KEEP* on the target net, which preserves the net name and prevents removing the net through RTL optimization.

[CLOCK_BUFFER_TYPE](#) can be defined in the RTL or in the XDC.

Note: [MAX_FANOUT](#) does not work on nets with [CLOCK_BUFFER_TYPE](#).

Architecture Support

All architectures.

Applicable Objects

- Ports ([get_ports](#)): Apply [CLOCK_BUFFER_TYPE](#) to any top-level clock port to describe what type of clock buffer to use, or to use no clock buffer.
- Nets ([get_nets](#)): Apply [CLOCK_BUFFER_TYPE](#) to any signal connected to a top-level clock port to describe what type of clock buffer to use, or to use no clock buffer.

Values

- **BUFG, BUFH, BUFIO, BUFMR, BUFR:** Directs the tool to infer the specified clock buffer for clock ports or nets.
- **NONE:** Directs the tool to not infer any clock buffers for the clocks.

Note: Use with [IO_BUFFER_TYPE](#) "NONE" to prevent Vivado synthesis from inferring any buffers.

Syntax

Verilog Syntax

```
(* clock_buffer_type = "none" *) input clk1;
```

VHDL Syntax

```
entity test is port(  
  in1 : std_logic_vector (8 downto 0);  
  clk : std_logic;  
  out1 : std_logic_vector(8 downto 0));  
  attribute clock_buffer_type : string;  
  attribute clock_buffer_type of clk: signal is "BUFR";  
end test;
```

XDC Syntax

```
set_property CLOCK_BUFFER_TYPE BUFR [get_nets <net_name>]
```

Affected Steps

- Synthesis
- Opt_Design

See Also

[IO_BUFFER_TYPE](#), page 241

CLOCK_DEDICATED_ROUTE

The CLOCK_DEDICATED_ROUTE property is enabled (TRUE) by default, and ensures that clock resource placement DRCs are considered error conditions that must be corrected prior to routing or bitstream generation. CLOCK_DEDICATED_ROUTE=FALSE downgrades the placement DRC to a warning and lets the Vivado router use fabric routing to connect from a clock-capable IO (CCIO) to a global clock resource such as an MMCM.



CAUTION! Setting `CLOCK_DEDICATED_ROUTE` to **FALSE** may result in sub-optimal clock delays, resulting in potential timing violations and other issues.

External user clocks must be brought into the FPGA on differential clock pin pairs called clock-capable inputs (CCIO). These CCIOs provide dedicated, high-speed routing to the internal global and regional clock resources to guarantee timing of various clocking features. Refer to the *7 Series FPGAs Clocking Resources User Guide* (UG472) [Ref 3], or the *UltraScale Architecture Clocking Resources User Guide* (UG572)) [Ref 9] for more information on clock placement rules.

The CLOCK_DEDICATED_ROUTE property is generally used when it becomes necessary to place clock components in such a way as to take clock routing off of the dedicated clock trees in the target FPGA, and use standard routing channels. This fabric routing may be fine if the clock is only used internally, but the clock will not be usable for any reasonable speed I/O interface. If the dedicated routes are not available, setting CLOCK_DEDICATED_ROUTE to FALSE demotes a clock placement DRC from an *ERROR* to a *WARNING* when a clock source is placed in a sub-optimal location compared to its load clock buffer.

Architecture Support

All architectures.

Applicable Objects

- Nets (`get_nets`) directly connected to the input of a global clock buffer (BUFG, BUFGCE, BUFGMUX, BUGCTRL).



IMPORTANT: `CLOCK_DEDICATED_ROUTE` must be set on a net segment at the highest level of design hierarchy, or the top-level net.

Values

- 7series devices
 - **TRUE**: Default clock placement and routing.
 - **BACKBONE**: Clock driver and load(s) must be placed in the same Clock Management Tile (CMT) column. The clock routing still uses dedicated global clock routing resources.
 - **FALSE**: Clock driver and load(s) can be placed anywhere in the device. The clock net can be routed with both global clock routing resources, and standard fabric routing resources. This can adversely affect the timing and performance of the clock net.
- UltraScale architecture
 - **TRUE**: Default clock placement and routing.
 - **SAME_CMT_COLUMN** (BACKBONE can also be used): Clock driver and load(s) must be placed in the same Clock Management Tile (CMT) column. The clock routing uses dedicated global clock routing resources.
 - **ANY_CMT_COLUMN**: Clock driver and load(s) can be placed in any CMT column and the net uses dedicated global clock routing resources. Note that this option is not available in 7 series devices.
 - **FALSE**: Clock driver and load(s) can be placed anywhere in the device. The clock net can be routed with both global clock routing resources, and standard fabric routing resources. This can adversely affect the timing and performance of the clock net.

Syntax

Verilog and VHDL Syntax

Not applicable

XDC Syntax

```
set_property CLOCK_DEDICATED_ROUTE [TRUE | FALSE | BACKBONE] [get_nets net_name]
```

Where

- `net_name` is the signal name directly connected to the input of a global clock buffer.

XDC Syntax Example

```
# Designates clk_net to have relaxed clock placement rules  
set_property CLOCK_DEDICATED_ROUTE FALSE [get_nets clk_net]
```

Affected Steps

- place_design
- report_drc

See Also

[CLOCK_LOW_FANOUT](#), page 171

CLOCK_DELAY_GROUP

The CLOCK_DELAY_GROUP property identifies related clocks, that have the same MMCM or PLL source, that should be grouped during placement and routing to reduce clock skew on timing paths between the clocks.



TIP: Clock matching (via the CLOCK_DELAY_GROUP property) is intended for use with clocks from same PLL/MMCM.

Architecture Support

UltraScale architecture.

Applicable Objects

- Clock nets (`get_nets`) connected to the output of global clock buffers (BUFG, BUFGCE, BUFGMUX, BUGCTRL) that need to be balanced.

Values

- **NAME:** A unique string identifier used by the Vivado placer to match the delays on specified clock nets.

Syntax

Verilog and VHDL Syntax

Not applicable

XDC Syntax

```
set_property CLOCK_DELAY_GROUP <name> [get_nets <clk_nets>]
```

Where

- `<name>` is the unique name to associate with the specified clock nets.
- `<clk_nets>` is a list of clock nets directly connected to the output of global clock buffers, that are driven by a common cell, such as an MMCM for example.

XDC Syntax Example

```
# Define a clock group to reduce skew between the nets.  
set_property CLOCK_DELAY_GROUP grp12 [get_nets {clk1_net clk2_net}]
```

Affected Steps

- place_design
- report_drc

See Also

[CLOCK_LOW_FANOUT](#), page 171

CLOCK_LOW_FANOUT

CLOCK_LOW_FANOUT is a boolean property that can be assigned to clocks that have a small number of loads and that should be contained in a single clock region. The property is assigned to clock nets driven by a global clock buffer.



TIP: A global clock buffer is a `BUFGCE`, `BUFGCE_DIV`, `BUFGCTRL`, `BUFG_GT`, `BUFG_PS`, `BUFG_HDIO`.

When CLOCK_LOW_FANOUT is TRUE, the loads should be contained within a single clock region and be driven by global clock resources. A load is defined as any leaf input pin on the clock network, not just sequential clock pins. For example, LUT pins are counted as loads. If there are too many loads on the net, the Vivado tool will return a warning and ignore the CLOCK_LOW_FANOUT property.

The CLOCK_LOW_FANOUT property can conflict with other clock or placement properties. For instance, if `CLOCK_DEDICATED_ROUTE` is specified on the same net with any value other than TRUE, the `CLOCK_DEDICATED_ROUTE` property takes precedence and `CLOCK_LOW_FANOUT` is ignored with a warning, `CLOCK_DELAY_GROUP` will take precedence over `CLOCK_LOW_FANOUT` if all of the members of the `CLOCK_DELAY_GROUP` cannot be placed in a single clock region. `USER_CLOCK_ROOT`, `LOC`, and `PBLOCK` properties can also create conflicts with the `CLOCK_LOW_FANOUT` property. In each of these cases `CLOCK_LOW_FANOUT` is ignored and a warning is returned.

Architecture Support

UltraScale architecture.

Applicable Objects

- Clock nets (`get_nets`) connected to the output of global clock buffers that should be constrained to a single clock region.

Values

- **TRUE:** The clock is a low fanout net and should be constrained into a single clock region.
- **FALSE:** The clock is not a low fanout signal, or should not be constrained to a single clock region (default).

Syntax

Verilog and VHDL Syntax

Not applicable

XDC Syntax

```
set_property CLOCK_LOW_FANOUT TRUE [get_nets <clk_nets>]
```

Where

- `<clk_nets>` is a list of clock nets directly connected to the output of global clock buffers, that are driven by a common cell, such as an MMCM for example.

XDC Syntax Example

```
# Define a clock group to reduce skew between the nets.  
set_property CLOCK_LOW_FANOUT TRUE [get_nets -of [get_pins block/myBufg/O]]
```

Affected Steps

- `place_design`
- `report_drc`

See Also

[CLOCK_DEDICATED_ROUTE](#), page 166

[CLOCK_DELAY_GROUP](#), page 169

[LOC](#), page 268

[PBLOCK](#), page 300

[USER_CLOCK_ROOT](#), page 362

CLOCK_REGION

The CLOCK_REGION property lets you assign a clock buffer to a specific clock region of an UltraScale device, while letting the Vivado placer assign the clock buffer to the best site within that region.



IMPORTANT: For UltraScale devices, it is not recommended to fix a Clock Buffer to a specific site, as you might do in clock planning a 7 series design. Instead, you can assign a Clock Buffer to a specific CLOCK_REGION and leave the clock resources available to the Vivado placer to determine the best clocking structure.

Architecture Support

UltraScale architecture.

Applicable Objects

- Global clock buffer cells (`get_cells`)
 - BUFG cells (BUFGCE, BUFGCTRL, BUFG_GT, BUFGCE_DIV)

Values

- `<VALUE>`: Specify the CLOCK_REGION to place the cell or cells into. The CLOCK_REGION is specified by name as `X#Y#`, or as returned by the `get_clock_regions` Tcl command.

Note: Refer to *Vivado Design Suite Tcl Command Reference Guide* (UG835) [Ref 13] for more information on the `get_clock_regions` command.

Syntax

Verilog and VHDL Syntax

Not applicable

XDC Syntax

```
set_property CLOCK_REGION X0Y2 [get_cells <cell>]
```

Where

- `<cell>` is an instance of a global clock buffer.

XDC Syntax Example

User assignment of the CLOCK_RERREGION would be performed in XDC as follows:

```
set_property CLOCK_REGION X4Y6 [get_cells {sys_clk_pll/inst/clkf_buf}]
```

Affected Steps

- place_design
- report_drc

See Also

[CLOCK_BUFFER_TYPE](#), page 164

[CLOCK_ROOT](#), page 175

CLOCK_ROOT



IMPORTANT: *The CLOCK_ROOT property has changed from a user-definable property to a read-only property. The user-definable property has been changed to USER_CLOCK_ROOT, which should be used instead.*

The CLOCK_ROOT property is a read-only property reflecting the current resource assignment of the driver, or root, of the global clock net in the physical design. The CLOCK_ROOT reflects the clock root assigned by the Vivado placer. The place and route tools will automatically assign the clock root to achieve the best timing for the design.

The CLOCK_ROOT value should match the user-defined [USER_CLOCK_ROOT](#) property if it is defined. The USER_CLOCK_ROOT property lets you manually assign the clock root.



TIP: *If the Vivado router is run with the EXPLORE directive, it can add additional clock roots to a net in order to improve the quality of the results.*

Architecture Support

UltraScale architecture.

Applicable Objects

- Global clock net (`get_nets`) directly connected to the output of a global clock buffer.

Value

- `<clock_region | pblock_name>`: Specifies the name of a clock region on the target part, or a defined Pblock in the current design.
- `<object>`: Specifies one or more clock nets, or net segments.

Syntax

Not applicable

Affected Steps

- Placement
- Routing

See Also

[CLOCK_BUFFER_TYPE](#), page 164

[CLOCK_REGION](#), page 173

[USER_CLOCK_ROOT](#), page 362

CONFIG_MODE

The CONFIG_MODE property defines which device configuration mode or modes to use for pin allocations, DRC reporting, and bitstream generation.



IMPORTANT: *COMPATIBLE_CONFIG_MODES* property has been deprecated in the 2013.3 release, and is replaced by the CONFIG_MODE property.

Xilinx FPGAs can be configured by loading application-specific configuration data, or a bitstream, into internal memory through special configuration pins. There are two general configuration datapaths: a serial datapath used to minimize the device pins required, and parallel datapaths for higher performance configuration. The CONFIG_MODE property defines which modes are used for the current design.

Refer to the *7 Series FPGAs Configuration User Guide* (UG470) [Ref 1], or the *UltraScale Architecture Configuration User Guide* (UG570) [Ref 7] for more information on device configuration modes.

Architecture Support

All architectures.

Applicable Objects

- Design (`current_design`)

Values



TIP: *Not all of the following values apply to all device architectures. Refer to the 7 Series FPGAs Configuration User Guide* (UG470) [Ref 1], or *UltraScale Architecture Configuration User Guide* (UG570) [Ref 7], for more information.

- S_SERIAL
- M_SERIAL
- S_SELECTMAP
- M_SELECTMAP
- B_SCAN
- S_SELECTMAP+READBACK
- M_SELECTMAP+READBACK
- B_SCAN+READBACK

- S_SELECTMAP32
- S_SELECTMAP32+READBACK
- S_SELECTMAP16
- S_SELECTMAP16+READBACK
- SPIx1
- SPIx2
- SPIx4
- SPIx8
- BPI8
- BPI16

Syntax

Verilog and VHDL Syntax

Not applicable

XDC Syntax

```
set_property CONFIG_MODE <value> [current_design]
```

Where *value* specifies the configuration mode.

XDC Syntax Example

```
# Specify using Configuration Mode Serial Peripheral Interface, 4-bit width
set_property CONFIG_MODE {SPIx4} [current_design]
```

Affected Steps

- I/O Planning
- place_design
- report_drc
- write_bitstream

CONFIG_VOLTAGE

Xilinx devices support configuration interfaces with 3.3V, 2.5V, 1.8V, or 1.5V I/O. The configuration interfaces include the JTAG pins in bank 0, the dedicated configuration pins in bank 0, and the pins related to specific configuration modes in bank 14 and bank 15 in the 7 series devices, and bank 65 in the UltraScale architecture. You can set the CONFIG_VOLTAGE property, or VCCO_0 voltage, to 3.3, 2.5, 1.8, or 1.5.

CONFIG_VOLTAGE must be set to the correct configuration voltage, in order to determine the I/O voltage support for the pins in bank 0. Refer to the *7 Series FPGAs Configuration User Guide* (UG470) [Ref 1], or the *UltraScale Architecture Configuration User Guide* (UG570) [Ref 7] for more information on configuration voltage.

The CFGBVS pin setting determines the I/O voltage support for bank 0 at all times. For 7 series devices in which bank 14 and bank 15 are the HR bank type, or bank 65 in UltraScale architecture, the CFGBVS pin and the respective CONFIG_VOLTAGE property determine the I/O voltage support during configuration.

Report DRC checks are run on Bank 0, 14, and 15 in the 7 series, or 0 and 65 in the UltraScale architecture, to determine compatibility of CONFIG_MODE settings on the current design. DRCs are issued based on IOSTANDARD and CONFIG_VOLTAGE settings for the bank. The configuration voltages are also used when exporting IBIS models.

Architecture Support

All architectures.

Applicable Objects

- Designs (`current_design`)

Values

- 1.5, 1.8, 2.5, or 3.3



IMPORTANT: For UltraScale+ devices, the CONFIG_VOLTAGE value must be 1.8.

Syntax

Verilog and VHDL Syntax

Not applicable

XDC Syntax

```
set_property CONFIG_VOLTAGE {1.5 | 1.8 | 2.5 | 3.3} [current_design]
```

XDC Syntax Example

```
# Configure I/O Bank 0 for 1.8V operation  
set_property CONFIG_VOLTAGE 1.8 [current_design]
```

Affected Steps

- place_design
- report_drc
- write_bitstream

See Also

[CFGBVS, page 162](#)

[CONFIG_MODE, page 177](#)

CONTAIN_ROUTING

The CONTAIN_ROUTING property restricts the routing of signals contained within a Pblock to use routing resources within the area defined by the Pblock. This prevents signals inside the Pblock from being routed outside the Pblock, and increases the reusability of the design.

By default the definition of a Pblock restricts the placement of logic assigned to the Pblock to within the area defined by the Pblock. This property has the same effect for routing. The CONTAIN_ROUTING property is specific to a Pblock and must come after the `create_pblock` commands in an XDC file.



TIP: The use of CONTAIN_ROUTING is highly recommended on all Pblocks associated with an OOC module in the Hierarchical Design flow. Refer to the Vivado Design Suite User Guide: Hierarchical Design (UG905) [Ref 21] for more information.

Only signals that are entirely owned by the Pblock cells will be contained within the Pblock. For example, if no BUFGMUX resources are found within the Pblock, paths from or to a BUFGMUX cannot be contained.

Architecture Support

All architectures.

Applicable Objects

- PBlocks (`get_pblocks`)

Values

- **TRUE:** Contain the routing of signals inside a Pblock to the area defined by the Pblock range.
- **FALSE:** Do not contain the routing of signals inside the Pblock. This is the default.

Syntax

Verilog and VHDL Syntax

Not applicable

XDC Syntax

```
set_property CONTAIN_ROUTING <TRUE / FALSE> [get_pblocks <pblock_name>]
```

Where:

- <pblock_name> specifies the PBlock or PBlocks to apply the property to.

XDC Example

```
set_property CONTAIN_ROUTING true [get_pblocks pblock_usbEngine0]  
set_property CONTAIN_ROUTING true [get_pblocks pblock_usbEngine1]
```

Affected Steps

- Routing

See Also

[EXCLUDE_PLACEMENT](#), page 211

[PBLOCK](#), page 300

CONTROL_SET_REMAP

While all registers support resets and clock enables, their use can significantly affect the end implementation in terms of performance, utilization, and power. Designs with a large number of unique control sets can have fewer options for placement, resulting in higher power and lower performance. The CONTROL_SET_REMAP property is placed on register primitives to trigger a control set reduction on a specific register during logical optimization ([opt_design](#)).

When a logic path ends at a fabric register (FD) clock enable, or synchronous set/reset, the property on the register instructs Vivado logic optimization to map the enable or reset signal to the data pin (D), which has a dedicated LUT connection and can be faster. If possible, the logic is combined with an existing LUT driving the D-input to prevent the insertion of extra levels of logic.



IMPORTANT: *This optimization is automatically triggered when the CONTROL_SET_REMAP property is detected on any register. DONT_TOUCH prevents the optimization on specified cells or hierarchy.*

For more information on reducing control sets, refer to this [link](#) in the *UltraFast Design Methodology Guide for the Vivado Design Suite* (UG949) [Ref 24] for more information.

Architecture Support

All architectures.

Applicable Objects

- Cells (`get_cells`)

Values

- **ENABLE:** Remaps the EN input to the D-input.
- **RESET:** Remaps the synchronous S or R input to the D-input.
- **ALL:** Same as ENABLE and RESET combined.
- **NONE:** do nothing. This is the default, and is the same as if the property were not set on the cell.

Syntax

Verilog and VHDL Syntax

Not applicable

XDC Syntax

```
set_property CONTROL_SET_REMAP <value> [get_cells <cell_pattern>]
```

XDC Syntax Example

```
# Specifies control set reduction based on Enable signals  
set_property CONTROL_SET_REMAP ENABLE [get_cells ff*]
```

Affected Steps

- opt_design

See Also

[EQUIVALENT_DRIVER_OPT](#), page 209

DCI_CASCADE

DCI_CASCADE defines a master-slave relationship between a set of high-performance (HP) I/O banks. The digitally controlled impedance (DCI) reference voltage is chained from the master I/O bank to the slave I/O banks.

DCI_CASCADE specifies which adjacent banks use the DCI Cascade feature, thereby sharing reference resistors with a master bank. If several I/O banks in the same I/O bank column are using DCI, and all of those I/O banks use the same VRN/VRP resistor values, the internal VRN and VRP nodes can be cascaded so that only one pair of pins for all of the I/O banks in the entire I/O column is required to be connected to precision resistors. DCI_CASCADE identifies the master bank and all associated slave banks for this feature. Refer to the *7 Series FPGAs SelectIO Resources User Guide* (UG471) [Ref 2], or the *UltraScale Architecture SelectIO Resources User Guide* (UG571) [Ref 8] for more information.

Architecture Support

- Kintex®-7 devices.
- Kintex UltraScale devices.
- Virtex®-7 devices.
- Virtex UltraScale devices.
- Larger Zynq®-7000 SoC devices.

Applicable Objects

- I/O Bank (`get_iobanks`)
 - High Performance (HP) bank type

Values

Valid High Performance (HP) bank numbers. See the *7 Series FPGAs Packaging and Pinout Product Specifications User Guide* (UG475) [Ref 5], or the *UltraScale and UltraScale+ FPGAs Packaging and Pinouts Product Specification User Guide* (UG575) [Ref 11] for more information.

Syntax

Verilog and VHDL Syntax

Not applicable

XDC Syntax

```
set_property DCI_CASCADE {slave_banks} [get_iobanks master_bank]
```

Where

- `slave_banks` is a list of the bank numbers of the slave banks.
- `master_bank` is the bank number of the designated master bank.

XDC Syntax Example

```
# Designate Bank 14 as a master DCI Cascade bank and Banks 15 and 16 as its slaves  
set_property DCI_CASCADE {15 16} [get_iobanks 14]
```

Affected Steps

- I/O planning
- `place_design`
- DRC
- `write_bitstream`
- `report_power`

DELAY_BYPASS

The DELAY_BYPASS property reduces the delay through the BUFIO in Xilinx 7 series FPGAs.

There is an intrinsic delay in the BUFIO to match the delay of the BUFR to allow for smooth data transference from those domains. For 7 series devices, this property disables that delay.

Architecture Support

7 series FPGAs.

Applicable Objects

- BUFIO (`get_cells`)

Values

- **TRUE:** Delay bypass is enabled.
- **FALSE:** Delay bypass is disabled (default).

Syntax

Verilog and VHDL Syntax

Not applicable

XDC Syntax

```
set_property DELAY_BYPASS TRUE [get_cells <cells>]
```

Where

- `<cells>` is a list of BUFIO cells to bypass the intrinsic delay.

XDC Syntax Example

```
set_property -name DELAY_BYPASS TRUE [get_cells clk_bufio]
```

Applicable Steps

- Timing Analysis

DIFF_TERM

The differential termination (DIFF_TERM) property supports the differential I/O standards for inputs and bidirectional ports. It is used to enable or disable the built-in, 100Ω, differential termination. Refer to the *7 Series FPGAs SelectIO Resources User Guide* (UG471) [Ref 2] for more information.

DIFF_TERM indicates a differential termination method should be used on differential input and bidirectional port buffers, and that the Vivado tool should add on-chip termination to the port.

Architecture Support

7 series FPGAs.



RECOMMENDED: For UltraScale architecture devices, you should use [DIFF_TERM_ADV](#) to enable differential termination.

Applicable Objects

- Ports (get_ports)
 - Input or bidirectional ports connected to a differential input buffer
- Applicable to elements using one of the following IOSTANDARDS:
 - LVDS, LVDS_25, MINI_LVDS_25
 - PPDS_25
 - RSDS_25

Values

- **TRUE:** Differential termination is enabled.
- **FALSE:** Differential termination is disabled (default).

Syntax



RECOMMENDED: Use the instantiation template from the Language Templates or the Vivado Design Suite 7 Series FPGA and Zynq-7000 SoC Libraries Guide (UG953) [Ref 25] to specify the proper syntax.

Verilog Syntax

Assign the DIFF_TERM parameter immediately before the port declaration:

```
(* DIFF_TERM = "TRUE" *) input PORT
```

Verilog Syntax Example

```
// Enables differential termination on the specified port  
(* DIFF_TERM = "TRUE" *) input CLK;
```

VHDL Syntax

Declare and specify the VHDL attribute as follows:

```
attribute DIFF_TERM : string;  
attribute DIFF_TERM of port_name : signal is "TRUE";
```

VHDL Syntax Example

```
-- Designates differential termination on the specified port  
attribute DIFF_TERM of CLK : signal is "TRUE";
```

XDC Syntax

```
set_property DIFF_TERM TRUE [get_ports port_name]
```

Where:

- `set_property DIFF_TERM` can be assigned to port objects.
- `port_name` is an input or bidirectional port connected to a differential buffer.

XDC Syntax Example

```
# Enables differential termination on port named CLK_p  
set_property DIFF_TERM TRUE [get_ports CLK_p]
```

Affected Steps

- I/O Planning
- report_ssn
- report_power

See Also

[DIFF_TERM_ADV](#), page 191

[IBUF_LOW_PWR](#), page 232

[IOSTANDARD](#), page 251

DIFF_TERM_ADV

The advanced differential termination (DIFF_TERM_ADV) property is intended for use with UltraScale architecture only, and is used to enable or disable the built-in, 100Ω, differential termination for inputs or bidirectional ports. DIFF_TERM_ADV indicates a differential termination method should be used on differential input and bidirectional port buffers, and that the Vivado Design Suite should add on-chip termination to the port.

DIFF_TERM_ADV is only available for inputs and bidirectional ports and can only be used with the appropriate V_{CCO} voltage. The V_{CCO} of the I/O bank must be connected to 1.8V for HP I/O banks, and 2.5V for HR I/O banks to provide 100Ω of effective differential termination. Refer to the *UltraScale Architecture SelectIO Resources User Guide* (UG571) [Ref 8] for more information.



IMPORTANT: *To support the migration of 7 Series designs to UltraScale architecture, the Vivado tool will automatically migrate the `DIFF_TERM` property to the `DIFF_TERM_ADV` property. However, in some cases this property is not supported, and should not be specified, or should be specified as "" (NULL) value.*

Architecture Support

UltraScale devices.

Applicable Objects

- Ports (`get_ports`)
 - Input or bidirectional ports connected to a differential input buffer
- Applicable to objects using one of the following IOSTANDARDS:
 - LVDS, LVDS_25, MINI_LVDS_25, SUB_LVDS
 - PPDS_25
 - RSDS_25
 - SLVS_400_25, and SLVS_400_18

Value

- **TERM_100:** Utilize the 100Ω on-chip differential termination.
- **TERM_NONE:** Do not utilize the on-chip differential termination (default).

Note: The TERM_NONE value is the default value when the DIFF_TERM_ADV property is valid, such as for supported IOSTANDARDS and voltage levels. However, where it is not supported, it should not be specified and DIFF_TERM_ADV=TERM_NONE can result in a DRC violation. In these cases you can set the property to a NULL value using one of the following commands:

```
reset_proeprty DIFF_TERM_ADV [get_ports <port_name>]
-or-
set_property DIFF_TERM_ADV "" [get_ports <port_name>]
```

Syntax

Verilog and VHDL Syntax

Not applicable

XDC Syntax

```
set_property DIFF_TERM_ADV TERM_100 [get_ports <port_name>]
```

Where:

- `set_property DIFF_TERM_ADV` can be assigned to input or bidirectional ports.
- `port_name` is an input or bidirectional port connected to a differential buffer.

XDC Syntax Example

```
# Enables differential termination on port named CLK_p
set_property DIFF_TERM_ADV TERM_100 [get_ports CLK_p]
```

Affected Steps

- I/O Planning
- report_drc
- report_ssn
- report_power

See Also

[DIFF_TERM](#), page 188

[IOSTANDARD](#), page 251

DIRECT_ENABLE

Apply DIRECT_ENABLE on an input port or other signal to have it go directly to the enable line of a flop when there is more than one possible enable or when you want to force the synthesis tool to use the enable lines of the flop.

Architecture Support

All architectures.

Applicable Objects

The DIRECT_ENABLE attribute can be placed on any port or signal.

Value

- **TRUE** (or **YES**): Use the enable lines of the flop.
- **FALSE** (or **NO**): Do not direct synthesis to use the enable line of a flop. This is the default.

Syntax

Verilog Example

```
(* direct_enable = "yes" *) input ena3;
```

VHDL Example

```
entity test is port(  
  in1 : std_logic_vector (8 downto 0);  
  clk : std_logic;  
  ena1, ena2, ena3 : in std_logic  
  out1 : std_logic_vector(8 downto 0));  
  attribute direct_enable : string;  
  attribute direct_enable of ena3: signal is "yes";  
end test;
```

XDC Syntax

```
set_property direct_enable yes [get_nets -of [get_ports ena3]]
```



IMPORTANT: For XDC usage, this attribute only works on type net, so you need to use the `get_nets` command for the object.

Affected Steps

- Synthesis

See Also

[DIRECT_RESET](#), page 195

[GATED_CLOCK](#), page 217

DIRECT_RESET

Apply DIRECT_RESET on an input port or other signal to have it go directly to the RESET line of a flop when there is more than one possible reset or when you want to force the synthesis tool to use the reset lines of the flop.

Architecture Support

All architectures.

Applicable Objects

The DIRECT_RESET attribute can be placed on any port or signal.

Value

- **TRUE** (or YES): Direct synthesis to use the RESET line of a flop.
- **FALSE** (or NO): Do not direct synthesis to use the RESET line. This is the default.

Syntax

Verilog Example

```
(* direct_reset = "yes" *) input rst3;
```

VHDL Example

```
entity test is port(  
  in1 : std_logic_vector (8 downto 0);  
  clk : std_logic;  
  rst1, rst2, rst3 : in std_logic  
  out1 : std_logic_vector(8 downto 0));  
  attribute direct_reset : string;  
  attribute direct_reset of rst3: signal is "yes";  
end test;
```

XDC Syntax

```
set_property direct_reset yes [get_nets -of [get_ports rst3]]
```



IMPORTANT: For XDC usage, this attribute only works on type net, so you need to use the `get_nets` command for the object.

Affected Steps

- Synthesis

See Also

[DIRECT_ENABLE](#), page 193

DONT_TOUCH

DONT_TOUCH directs the tool to not optimize a user hierarchy, instantiated component, or signal, so that optimization does not occur across the module boundary, or eliminate the object. While this can assist floorplanning, analysis, and debugging, it may inhibit optimization, resulting in a larger, slower design.



IMPORTANT: Xilinx recommends setting this attribute in the RTL source files. Signals that need to be kept are often optimized before the XDC file is read. Therefore, setting this attribute in the RTL ensures that the attribute is used.

The DONT_TOUCH property works in the same way as KEEP or KEEP_HIERARCHY; however, unlike KEEP and KEEP_HIERARCHY, DONT_TOUCH is forward-annotated to place and route to prevent logic optimization during implementation. The effect of DONT_TOUCH on various objects is as follows:

- **Primitive Instance:** Do not remove the instance. However, the tool can connect or disconnect pins of the instance.
- **Hierarchical Instance:** Do not remove the instance or add or remove any pins of the instance. The tool can connect or disconnect pins and optimize logic inside the hierarchical module. However, optimization may not move logic into or out of the hierarchical module. This is a constraint on the hierarchical boundary of the instance.



TIP: Register all the outputs of a hierarchical instance with DONT_TOUCH applied.

- **Hierarchical Net:** Do not remove the net, or connect or disconnect any pins on the net.



TIP: On a hierarchical net, DONT_TOUCH will preserve only the hierarchical segment it is attached to, so you will need to attach it to all segments you want to preserve.

DONT_TOUCH is not supported on individual ports of a module or entity. If you need to preserve specific ports put DONT_TOUCH on the module itself, or use the following Vivado synthesis setting:

```
flatten_hierarchy = "none"
```

Be careful when using DONT_TOUCH, KEEP, or KEEP_HIERARCHY. In cases where other attributes are in conflict with DONT_TOUCH, the DONT_TOUCH attribute takes precedence.

Architecture Support

All architectures.

Applicable Objects

- This attribute can be placed on any signal, hierarchical module, or primitive instance.
 - Cells (`get_cells`)
 - Nets (`get_nets`)

Values

- **FALSE**: Allows optimization across the hierarchy. This is the default setting.
- **TRUE**: Preserves the hierarchy by not allowing optimization across the hierarchy boundary. Preserves an instantiated component or a net to prevent it from being optimized out of the design.

Syntax

Verilog Syntax

Place the Verilog attribute immediately before the user hierarchy instantiation:

```
(* DONT_TOUCH = "{TRUE|FALSE}" *)
```

Verilog Syntax Example

```
// Preserve the hierarchy of instance CLK1_rst_sync
(* DONT_TOUCH = "TRUE" *) reset_sync #(
    .STAGES(5)
) CLK1_rst_sync (
    .RST_IN(RST | ~LOCKED),
    .CLK(clk1_100mhz),
    .RST_OUT(rst_clk1)
);
```

Wire Example

```
(* dont_touch = "true" *) wire sig1;
assign sig1 = in1 & in2;
assign out1 = sig1 & in2;
```

Module Example

```
(* DONT_TOUCH = "true|yes" *)
module example_dt_ver
    (clk,
    In1,
    In2,
    out1);
```

Instance Example

```
(* DONT_TOUCH = "true|yes" *) example_dt_ver U0
```

```
(.clk(clk),
.in1(a),
.in2(b),
.out1(c));
```

VHDL Syntax

Declare the VHDL attribute as follows:

```
attribute DONT_TOUCH : string;
```

Specify the VHDL attribute as follows:

```
attribute DONT_TOUCH of name: label is "{TRUE|FALSE}";
```

Where

- name is the instance name of a user defined instance.

VHDL Syntax Example

```
attribute DONT_TOUCH : string;
-- Preserve the hierarchy of instance CLK1_rst_sync
attribute DONT_TOUCH of CLK1_rst_sync: label is "TRUE";
...
CLK1_rst_sync : reset_sync
  PORT MAP (
    RST_IN => RST_LOCKED,
    CLK => clk1_100mhz,
    RST_OUT => rst_clk1
  );
```

XDC Syntax

```
set_property DONT_TOUCH {TRUE|FALSE} [get_cells <instance_name>]
set_property DONT_TOUCH {TRUE|FALSE} [get_nets <net_name>]
```

Where:

- instance_name is a leaf cell or hierarchical cell.
- net_name is the name of a hierarchical net.

XDC Syntax Example

```
# Preserve the hierarchy of instance CLK1_rst_sync
set_property DONT_TOUCH TRUE [get_cells CLK1_rst_sync]

# Preserve all segments of the hierarchical net named by the Tcl variables
set_property DONT_TOUCH [get_nets -segments $hier_net]
```

Affected Steps

- synth_design

- `opt_design`
- `phys_opt_design`
- `floorplanning`

See Also

[KEEP](#), page 258

[KEEP_HIERARCHY](#), page 263

[MARK_DEBUG](#), page 285

DQS_BIAS

DQS_BIAS is a property of the differential input buffer or bidirectional buffer primitive (IBUFDS, IOBUFDS).

The DQS_BIAS attribute provides an optional DC bias at the inputs of certain pseudo-differential I/O standards (DIFF_SSTL) and true differential I/O standards (LVDS). If nothing is driving the buffer, DQS_BIAS provides a weak bias so that the logic state is not unknown in pseudo-differential I/O standards.

DQS_BIAS provides a pull-up/pull-down feature required for some DQS memory interface pins.



RECOMMENDED: *Because DQS_BIAS affects the logic function of the design, it should be defined via a Verilog parameter statement, or VHDL generic_map, in order to correctly support simulation. However, it is also supported as an XDC property*

In high-performance (HP) I/O banks, DQS_BIAS can be used to support differential inputs, such as LVDS. The use of DQS_BIAS can provide the DC-bias in AC-coupled LVDS applications. See the *7 Series FPGAs SelectIO Resources User Guide* (UG471) [Ref 2], or the *UltraScale Architecture SelectIO Resources User Guide* (UG571) [Ref 8] for more information.

Note: DQS_BIAS is not available in high-range (HR) I/O banks for true differential I/O standards.

Architecture Support

All architectures.

Applicable Objects

- Ports (`get_ports`)
 - Differential Input buffers: IBUFDS, IBUFDS_IBUFDISABLE, IBUFDS_INTERMDISABLE, IBUFDSE3
 - Differential IO buffers: IOBUFDS, IOBUFDS_DCIEN, IOBUFDS_INTERMDISABLE, IOBUFDSE3, IBUFGDS

Values

- TRUE: Enable the DC bias voltage on the input or bidirectional buffer.
- FALSE: Disable DQS_BIAS on the buffer.

Note: When `EQUALIZATION` = `EQ_NONE`, the DQS_BIAS must be FALSE. Any other EQUALIZATION value (`EQ_LEVEL1`, `EQ_LEVEL2`...) can support either DQS_BIAS of TRUE or FALSE.

Syntax

Verilog Syntax

Assign the DQS_BIAS parameter on the instantiated differential buffer.

Note: To set this attribute when inferring I/O buffers, place the proper Verilog attribute syntax before the top-level output port declaration.

Verilog Syntax Example

The following example enables differential termination on the IBUFDS instance named **clk_ibufds**.

```
// IBUFDS: Differential Input Buffer
// Virtex UltraScale
// Xilinx HDL Language Template, version 2013.4
IBUFDS #(
  .DIFF_TERM_ADV("TERM_100"), // Differential Termination
  .DQS_BIAS("FALSE"), // (FALSE, TRUE)
  .IBUF_LOW_PWR("TRUE"), //
  .IOSTANDARD("LVDS_25") // Specify the input I/O standard
) clk_ibufds (
  .O(clk), // Buffer output
  .I(CLK_p), // Diff_p buffer input (connect directly to top-level port)
  .IB(CLK_n) // Diff_n buffer input (connect directly to top-level port)
);
// End of clk_ibufds instantiation
```

VHDL Syntax

Assign the generic DQS_BIAS on the instantiated differential buffer.

VHDL Syntax Example

The following example enables differential termination on the IBUFDS instance named **clk_ibufds**.

```
-- IBUFDS: Differential Input Buffer
-- Virtex UltraScale
-- Xilinx HDL Language Template, version 2013.4
clk_ibufds : IBUFDS
generic map (
  DIFF_TERM_ADV => TERM_100, -- Differential Termination
  DQS_BIAS => "TRUE" -- (FALSE, TRUE)
  IOSTANDARD => "LVDS_25")
port map (
  O => clk, -- Buffer output
  I => CLK_p, -- Diff_p buffer input (connect directly to top-level port)
  IB => CLK_n -- Diff_n buffer input (connect directly to top-level port)
);
-- End of clk_ibufds instantiation
```

XDC Syntax

The DQS_BIAS attribute uses the following syntax in the XDC file:

```
set_property DQS_BIAS [TRUE | FALSE] [get_cells instance_name]
```

Where:

- **set_property DQS_BIAS** can be assigned to input or bidirectional ports, or to differential buffers.
- **instance_name** is an input or bidirectional differential buffer instance.

XDC Syntax Example

```
# Enable DQS_BIAS on the specified buffer  
set_property DQS_BIAS TRUE [get_cells clk_ibufds]
```

Affected Steps

- Synthesis
- Simulation

See Also

[EQUALIZATION](#), page 207

DRIVE

DRIVE specifies output buffer drive strength in mA for output buffers configured with I/O standards that support programmable output drive strengths.

Architecture Support

All architectures.

Applicable Objects

- Ports (`get_ports`)
 - Output or bidirectional ports connected to output buffers

Values

Integer values:

- 2
- 4
- 6
- 8
- 12 (default)
- 16
- 24 (this value is not applicable to UltraScale architecture.)

Syntax

Verilog Syntax

For both inferred and instantiated output buffers, place the proper Verilog parameter syntax before the top-level output port declaration.

```
(* DRIVE = "{2|4|6|8|12|16|24}" *)
```

Verilog Syntax Example

```
// Sets the drive strength on the STATUS output port to 2 mA  
(* DRIVE = "2" *) output STATUS,
```

VHDL Syntax

For both inferred and instantiated output buffers, place the proper VHDL attribute syntax before the top-level output port declaration.

Declare and specify the VHDL attribute as follows:

```
attribute DRIVE : integer;  
attribute DRIVE of port_name : signal is value;
```

Where:

- port_name is a top-level output port.

VHDL Syntax Example

```
STATUS : out std_logic;  
attribute DRIVE : integer;  
-- Sets the drive strength on the STATUS output port to 2 mA  
attribute DRIVE of STATUS : signal is 2;
```

XDC Syntax

```
set_property DRIVE value [get_ports port_name]
```

XDC Syntax Example

```
# Sets the drive strength of the port STATUS to 2 mA  
set_property DRIVE 2 [get_ports STATUS]
```

Affected Steps

- I/O Planning
- Report Noise
- Report Power

See Also

Refer to the following design elements in the *Vivado Design Suite 7 Series FPGA and Zynq-7000 SoC Libraries Guide* (UG953) [Ref 25], or the *UltraScale Architecture Libraries Guide* (UG974) [Ref 26]:

- OBUF
- OBUFT
- IOBUF

EDIF_EXTRA_SEARCH_PATHS

This property defines a search path on the current fileset for the Vivado Design Suite to look for EDIF files referenced by the design.



TIP: *The following error occurs during implementation when the Vivado Design Suite is unable to locate the EDIF netlist associated with the blackbox. This can be fixed by defining the `EDIF_EXTRA_SEARCH_PATHS`:*

`"ERROR: [Opt 31-30] Blackbox module11 is driving pin I of primitive cell OBUF_inst. The blackbox cannot be found in the existing library."`

Architecture Support

All architectures.

Applicable Objects

- Source Fileset (`current_fileset`)

Values

- **Pathname:** Specifies the search path for the Vivado tool to locate EDIF files in use by the current fileset.

Syntax

Verilog and VHDL Syntax

Not applicable

XDC Syntax

```
set_property EDIF_EXTRA_SEARCH_PATHS <path_to_edif_file> [current_fileset]
```

XDC Syntax Example

```
# Specifies search path for EDIF files
set_property EDIF_EXTRA_SEARCH_PATHS C:/Data/Design1/EDIF [current_fileset]
```

Affected Steps

- link_design
- opt_design

EQUALIZATION

EQUALIZATION is available on differential receivers, implementing specific I/O standards, to overcome frequency-dependent attenuation through the transmission line.

Linear receiver equalization provides an AC gain at the receiver to compensate for high-frequency losses through the transmission line.



TIP: Equalization at the receiver can be combined with *PRE_EMPHASIS* at the transmitter to improve the overall signal integrity.

Architecture Support

UltraScale devices.

Applicable Objects

- Ports (`get_ports`)

Value



IMPORTANT: The EQUALIZATION values are not specifically calibrated. The recommendation is to run simulations to determine the best setting for the specific frequency and transmission line characteristics in the design. In some cases, lower equalization settings may provide better results than over-equalization. Over-equalization degrades the signal quality instead of improving it.

The allowed values for the EQUALIZATION attribute are:

- In HP I/O Banks
 - EQ_LEVEL0
 - EQ_LEVEL1
 - EQ_LEVEL2
 - EQ_LEVEL3
 - EQ_LEVEL4
 - EQ_NONE (default)
- In HR I/O Banks
 - EQ_LEVEL0, EQ_LEVEL0_DC_BIAS
 - EQ_LEVEL1, EQ_LEVEL1_DC_BIAS

- EQ_LEVEL2, EQ_LEVEL2_DC_BIAS
- EQ_LEVEL3, EQ_LEVEL3_DC_BIAS
- EQ_LEVEL4, EQ_LEVEL4_DC_BIAS
- EQ_NONE (default)

Syntax

Verilog and VHDL Syntax

Not applicable

XDC Syntax

The EQUALIZATION attribute uses the following syntax in the XDC file:

```
set_property EQUALIZATION value [get_ports port_name]
```

Where:

- `set_property EQUALIZATION` enables linear equalization at the input buffer.
- `<Value>` is one of the supported EQUALIZATION values for the specified port.
- `port_name` is an input or bidirectional port connected to a differential buffer.

See Also

[LVDS_PRE_EMPHASIS](#), page 283

[PRE_EMPHASIS](#), page 312

EQUIVALENT_DRIVER_OPT

The Vivado tool merges the drivers of all logically-equivalent signals into single drivers when the `-merge_equivalent_drivers` option is specified during logic optimization (`opt_design`). Refer to this [link](#) in the *Vivado Design Suite User Guide: Implementation* (UG904) [Ref 20] for more information.

The EQUIVALENT_DRIVER_OPT cell property lets you control which equivalent nets and drivers are merged or not when running `opt_design`:

- Setting the EQUIVALENT_DRIVER_OPT property to MERGE on the original driver, and its replicas, triggers the merge equivalent driver phase during `opt_design`, and merges the logically equivalent drivers that have that property.
- Setting the EQUIVALENT_DRIVER_OPT property to KEEP on the original driver, and its replicas, prevents the merging of those specified drivers during the equivalent driver merging and the control set merging phase. This excludes the specified drivers, but otherwise runs equivalent driver merging on the rest of the design.

Architecture Support

All architectures.

Applicable Objects

- Cells (`get_cells`)

Values

- **Merge:** Enable the equivalent driver merging optimization on the specified cells only.
- **Keep:** Disables the equivalent driver merging optimization on the specified cells, but otherwise merge the rest of the design.

Syntax

Verilog and VHDL Syntax

Not applicable

XDC Syntax

```
set_property EQUIVALENT_DRIVER_OPT < MERGE | KEEP > [get_cells <instance>]
```

XDC Syntax Example

```
# Specifies to MERGE equivalent drivers on the specified cells  
set_property EQUIVALENT_DRIVER_OPT MERGE [get_cells U0/mem_reg_mux_sel_reg_0*]
```

Affected Steps

- opt_design

See Also

[CONTROL_SET_REMAP](#), page 183

EXCLUDE_PLACEMENT

The EXCLUDE_PLACEMENT property is used to indicate that the device resources inside of the area defined by a Pblock should only be used for logic contained in the Pblock.

The default is to allow the Vivado placer to place logic not assigned to a Pblock within the range of resources reserved by the Pblock. This property prevents that, and reserves the logic resources for the Pblock.



TIP: This only closes the Pblock's logic resources. Outside logic can still use routing resources within the area defined by the Pblock.

Architecture Support

All devices.

Applicable Objects

- Pblocks (get_pblocks)

Values

- **TRUE:** Reserve the device logic resources inside a Pblock for use by logic assigned to the Pblock, thus preventing placement of outside logic.
- **FALSE:** Do not reserve logic resources inside the Pblock.

Syntax

Verilog and VHDL Syntax

Not applicable

XDC Syntax

```
set_property EXCLUDE_PLACEMENT TRUE [get_pblocks test]
```

Affected Steps

- Floorplanning
- Placement

See Also

[CONTAIN_ROUTING](#), page 181

[PBLOCK](#), page 300

FSM_ENCODING

FSM_ENCODING controls how a state machine is encoded during synthesis.

As a default, the Vivado synthesis tool chooses an encoding protocol for state machines based on internal algorithms that determine the best solution for most designs. However, the FSM_ENCODING property lets you specify the state machine encoding of your choice.

Architecture Support

All architectures.

Applicable Objects

- State machine registers

Values

- **AUTO**: This is the default behavior when FSM_ENCODING is not specified. It allows the Vivado synthesis tool to determine the best state machine encoding method. In this case, the tool may use different encoding styles for different state machine registers in the same design.
- **ONE_HOT**
- **SEQUENTIAL**
- **JOHNSON**
- **GRAY**
- **NONE**: This disables state machine encoding within the Vivado synthesis tool for the specified state machine registers. In this case the state machine is synthesized as logic.

Verilog Syntax

```
(* fsm_encoding = "one_hot" *) reg [7:0] my_state;
```

VHDL Syntax

```
type count_state is (zero, one, two, three, four, five, six, seven);  
signal my_state : count_state;  
attribute fsm_encoding : string;  
attribute fsm_encoding of my_state : signal is "sequential";
```

XDC Syntax

Not applicable

Affected Steps

- Synthesis

See Also

[FSM_SAFE_STATE](#), page 215

FSM_SAFE_STATE

This attribute can be set in both the RTL and in the XDC.

The Vivado synthesis tool supports extraction of Finite State Machines (FSM) in a variety of configurations as determined by the [FSM_ENCODING](#) property, or the `-fsm_extraction` command line option for Vivado synthesis. Refer to the *Vivado Design Suite User Guide: Synthesis* (UG901) [Ref 18] for more information.

A state machine can enter into an invalid, or “unreachable” state that causes the design to fail. `FSM_SAFE_STATE` tells synthesis to insert logic into the state machine that detects if there is an invalid state and then puts it into a known state on the next clock cycle. If an FSM enters an invalid state, the `FSM_SAFE_STATE` property defines a recovery state for use when an FSM is synthesized in the Vivado synthesis tool.



TIP: While providing for safe recovery of FSM states, this property can affect the quality of synthesis results, typically resulting in less performance with greater area.

Architecture Support

All architectures.

Applicable Objects

- State machine registers.

Values

- **reset_state:** Return the state machine to the RESET state, as determined by the Vivado synthesis tool.
- **power_on_state:** Return the state machine to the POWER_ON state, as determined by the Vivado synthesis tool.
- **default_state:** Return the state machine to the default state, as defined by the state machine; even if that state is unreachable, using Hamming-2 encoding detection for one bit/flip.
- **auto_safe_state:** implies Hamming-3 encoding.

Syntax

Verilog Example

```
(* fsm_safe_state = "reset_state" *) reg [2:0] state;  
(* fsm_safe_state = "reset_state" *) reg [7:0] my_state;
```

VHDL Example

```
type count_state is (zero, one, two, three, four, five, six, seven);  
signal my_state : count_state;  
attribute fsm_safe_state : string;  
attribute fsm_safe_state of my_state : signal is "power_on_state";
```

XDC Example

```
set_property fsm_safe_state reset_state [get_cells state_reg*]
```

Affected Steps

- Synthesis

See Also

[FSM_ENCODING](#), page 213

GATED_CLOCK

Use the GATED_CLOCK property to enable Vivado synthesis to perform conversion of gated clocks. Convert clock gating logic to utilize the flop enable pins when available. This optimization can eliminate logic and simplify the netlist.

This RTL attribute that instructs the tool about which signal in the gated logic is the clock. The attribute is placed on the signal or port that is the clock.

This attribute can only be set in the RTL.

Note: You can also use a switch in the Vivado synthesis tool that instructs the tool to attempt the conversion:

```
synth_design -gated_clock_conversion
```

Architecture Support

All architectures.

Applicable Objects

- Clock input port
- Clock signal

Values

- **FALSE:** Disables the gated clock conversion.
- **TRUE:** Gated clock conversion occurs if the GATED_CLOCK attribute is set in the RTL code. This option gives you more control of the outcome.
- **AUTO:** Gated clock conversion occurs if either of the following events are true:
 - The GATED_CLOCK property is set to TRUE
 - The Vivado synthesis can detect the gate and there is a valid clock constraint set. This option lets the tool make decisions.

Syntax

Verilog Example

```
(* gated_clock = "true" *) input clk;
```

VHDL Example

```
entity test is port (  
  in1, in2 : in std_logic_vector(9 downto 0);  
  en : in std_logic;  
  clk : in std_logic;  
  out1 : out std_logic_vector( 9 downto 0));  
attribute gated_clock : string;  
attribute gated_clock of clk : signal is "true";  
end test;
```

XDC Example

Not applicable.

Affected Steps

- Synthesis

GENERATE_SYNTH_CHECKPOINT

By default, the Vivado Design Suite uses an out-of-context (OOC) design flow to synthesize IP cores from the Vivado IP catalog, and block designs from the Vivado IP integrator. The OOC flow reduces design cycle time, and eliminates design iterations, letting you save synthesis results in design checkpoint (DCP) files. The GENERATE_SYNTH_CHECKPOINT property determines whether the post-synthesis checkpoint will be generated as an output product for the associated IP file (XCI) or block design (BD) file. Refer to this [link](#) in the *Vivado Design Suite User Guide: Designing with IP* (UG896) [Ref 16], or this [link](#) in *Vivado Design Suite User Guide: Designing IP Subsystems Using IP Integrator* (UG994) [Ref 27] for more information.

The Vivado Design Suite automatically generates the synthesized design checkpoint file (DCP) needed to support the out-of-context (OOC) design flow when generating the output products for an IP or block design. OOC modules are seen as black boxes in the top-level design until the synthesized design is opened and all the OOC checkpoints are integrated.



IMPORTANT: *Vivado implementation resolves black boxes by extracting the netlists from the DCP of the IP and BD.*

For block design files (.bd), the SYNTH_CHECKPOINT_MODE property determines how the DCP for the block design will be synthesized. By default, the block design will be synthesized as Out-of-Context per IP, but you change the default mode by manually setting the SYNTH_CHECKPOINT_MODE property.

When generating the output products for an included IP or BD, you can decide whether to use the out-of-context flow, including the creation of a synthesis Design Checkpoint (DCP), or to let the IP be globally synthesized as part of the top-level design.

You can set the GENERATE_SYNTH_CHECKPOINT property to FALSE, or 0, to disable the OOC flow, and disable the generation of the synthesized DCP output product for specified XCI or BD files.

This property will become read-only if the IP is locked for any reason. In this case, you can run **Reports > Report IP Status** in the Vivado IDE, or run the `report_ip_status` Tcl command to see why the IP is locked. You will not be able to generate the DCP without first updating the IP to the latest version in the Vivado IP catalog. Refer to this [link](#) in the *Vivado Design Suite User Guide: Designing with IP* (UG896) [Ref 16] for more information.

Architecture Support

All architectures.

Applicable Objects

- IP Files (XCI) or Block Design Files (BD)
- (get_files)

Values

- **TRUE:** Generate the synthesis design checkpoint (DCP) as part of the output products of an IP or block design, to enable the out-of-context (OOC) design flow (default).
- **FALSE:** Do not generate the synthesis DCP and disable the OOC flow.

Syntax

Verilog and VHDL Syntax

Not applicable

XDC Syntax

```
set_property GENERATE_SYNTH_CHECKPOINT {TRUE | FALSE} [get_files <filename>]
```

Where

- <filename> is the filename of an IP (XCI) or of a block design (BD).

XDC Syntax Example

```
set_property GENERATE_SYNTH_CHECKPOINT false [get_files char_fifo.xci]
```



TIP: A warning will be returned by the tool if you try to assign or query the `GENERATE_SYNTH_CHECKPOINT` property on an object other than an XCI or BD file.

Affected Steps

- Synthesis
- Implementation

See Also

[SYNTH_CHECKPOINT_MODE](#), page 349

H_SET and HU_SET

Hierarchical sets are collections of logic elements based on the hierarchy of the design as defined by the HDL source files. H_SET, HU_SET, and U_SET are attributes within the HDL design source files, and do not appear in the synthesized or implemented design. They are used when defining Relatively Placed Macros, or RPMs in the RTL design. For more information on using these properties, and defining RPMs, refer to the *Vivado Design Suite User Guide: Using Constraints* (UG903) [Ref 19].

H_SET is a property that is implied due to the presence of RLOC properties on logic cells in the hierarchy of a design. Logic elements inside of a hierarchical block, that have the RLOC property, are automatically assigned to the same Hierarchical Set, or H_SET.

Each hierarchical module is assigned an H_SET property based on the instance name of the module. Each hierarchical module may only have a single H_SET name, and all logic elements inside that hierarchy are elements of that H_SET.

Note: H_SET is only defined if there is no HU_SET or U_SET defined, but RLOC is defined.

You can also manually create a User-defined Hierarchical Set, or HU_SET, or a User-defined Set, or U_SET, that is not dependant on the hierarchy of the design.

You can define multiple HU_SET names for a single hierarchical module, and assign specific instances of that hierarchy to the HU_SET. This allows you to divide the logic elements of a single hierarchical module into multiple HU_SETs.



IMPORTANT: *When using H_SET or HU_SET, the KEEP_HIERARCHY property is also required for Vivado Synthesis to preserve the hierarchy for the RPM in the synthesized design.*

When RLOC is also present in the RTL source files, the H_SET, HU_SET, and U_SET properties get translated to a read-only RPM property on cells in the synthesized netlist. The HU_SET and U_SET are visible on the RTL source file in the Text editor in the Vivado Design Suite. However, in the Properties window of a cell object, the RPM property is displayed.

Architecture Support

All architectures.

Applicable Objects

The HU_SET property may be used in one or more of the following design elements, or categories of design elements. Refer to the *Vivado Design Suite 7 Series FPGA and Zynq-7000 SoC Libraries Guide* (UG953) [Ref 25] or the *UltraScale Architecture Libraries Guide* (UG974) [Ref 26] for more information on the specific design elements:

- Registers
- LUT
- Macro Instance
- RAMS
- RAMD
- RAMB18/FIFO18
- RAMB36/FIFO36
- DSP48

Values

- **<NAME>**: A unique name for the HU_SET.

Syntax

Verilog Syntax

This is a Verilog attribute used in combination with the RLOC property to define the set content of a hierarchical block that will define an RPM in the synthesized netlist. Place the Verilog attribute immediately before the instantiation of a logic element.

```
(* RLOC = "X0Y0", HU_SET = "h0" *) FD sr0 (.C(clk), .D(sr_1n), .Q(sr_0));
```

Verilog Example

The following Verilog module defines RLOC and HU_SET properties for the shift register Flops in the module.

```
module ffs (  
    input  clk,  
    input  d,  
    output q  
);  
  
    wire  sr_0, sr_0n;  
    wire  sr_1, sr_1n;  
    wire  sr_2, sr_2n;  
    wire  sr_3, sr_3n;
```

```

wire  sr_4, sr_4n;
wire  sr_5, sr_5n;
wire  sr_6, sr_6n;
wire  sr_7, sr_7n;

wire  inr, inrn, outr;

inv  i0 (sr_0, sr_0n);
inv  i1 (sr_1, sr_1n);
inv  i2 (sr_2, sr_2n);
inv  i3 (sr_3, sr_3n);
inv  i4 (sr_4, sr_4n);
inv  i5 (sr_5, sr_5n);
inv  i6 (sr_6, sr_6n);
inv  i7 (sr_7, sr_7n);
inv  i8 (inr, inrn);

(* RLOC = "X0Y0", HU_SET = "h0" *) FD sr0 (.C(clk), .D(sr_1n), .Q(sr_0));
(* RLOC = "X0Y0", HU_SET = "h0" *) FD sr1 (.C(clk), .D(sr_2n), .Q(sr_1));
(* RLOC = "X0Y1", HU_SET = "h0" *) FD sr2 (.C(clk), .D(sr_3n), .Q(sr_2));
(* RLOC = "X0Y1", HU_SET = "h0" *) FD sr3 (.C(clk), .D(sr_4n), .Q(sr_3));
(* RLOC = "X0Y0", HU_SET = "h1" *) FD sr4 (.C(clk), .D(sr_5n), .Q(sr_4));
(* RLOC = "X0Y0", HU_SET = "h1" *) FD sr5 (.C(clk), .D(sr_6n), .Q(sr_5));
(* RLOC = "X0Y1", HU_SET = "h1" *) FD sr6 (.C(clk), .D(sr_7n), .Q(sr_6));
(* RLOC = "X0Y1", HU_SET = "h1" *) FD sr7 (.C(clk), .D(inrn), .Q(sr_7));
(* LOC = "SLICE_X0Y0" *) FD inq (.C(clk), .D(d), .Q(inr));
FD outq (.C(clk), .D(sr_0n), .Q(outr));

assign q = outr;

endmodule // ffs
    
```

In the preceding example, you will need to specify the KEEP_HIERARCHY property to instances of the ffs module to preserve the hierarchy and define the RPM in the synthesized design:

```

module top (
    input  clk,
    input  d,
    output q
);

wire  c1, c2;

(* KEEP_HIERARCHY = "YES" *) ffs u0 (clk, d, c1);
(* KEEP_HIERARCHY = "YES" *) ffs u1 (clk, c1, c2);
(* KEEP_HIERARCHY = "YES" *) ffs u2 (clk, c2, q);

endmodule // top
    
```

VHDL Syntax

Declare the VHDL attribute as follows:

```
attribute HU_SET : string;
```

Specify the VHDL constraint as follows:

```
attribute HU_SET of {component_name | entity_name | label_name} :  
{component|entity|label} is "NAME";
```

Where:

- {component_name | entity_name | label_name} is the design element.
- {component|entity|label} is the instance ID of the design element.
- "NAME" is the unique set name to give to the HU_SET.

XDC Syntax

The HU_SET property can not be defined using XDC constraints. The HU_SET property, when present on logic elements with the RLOC property, defines relatively placed macros (RPMs), and results in the read-only RPM property in the netlist of synthesized designs.



TIP: You can use the `create_macro` and `update_macro` commands to define macro objects in the Vivado Design Suite, that act like RPMs within the design. Refer to the Vivado Design Suite Tcl Command Reference Guide (UG835) [Ref 13] for more information on these commands.

Affected Steps

- Design Floorplanning
- place_design
- synth_design

See Also

[KEEP_HIERARCHY](#), page 263

[RLOC](#), page 330

[RLOCS](#), page 334

[RLOC_ORIGIN](#), page 336

[RPM](#), page 341

[U_SET](#), page 352

HIODELAY_GROUP

HIODELAY_GROUP groups IDELAYCTRL components to their associated IDELAY or ODELAY instances for proper placement and replication.

If you use HIODELAY_GROUP to assign a group name to an IDELAYCTRL, you need to also associate an IDELAY or ODELAY cell to the group using the same HIODELAY_GROUP property.



IMPORTANT: *While an HIODELAY_GROUP can contain multiple cells, a cell can only be assigned to one HIODELAY_GROUP.*

The following example uses `set_property` to group all the IDELAY/ODELAY elements associated with a specific IDELAYCTRL.

```
set_property HIODELAY_GROUP IO_DLY1 [get_cells MY_IDELAYCTRL_inst]
set_property HIODELAY_GROUP IO_DLY1 [get_cells MY_IDELAY_inst]
set_property HIODELAY_GROUP IO_DLY1 [get_cells MY_ODELAY_inst]
```

Difference Between HIODELAY_GROUP and IODELAY_GROUP

HIODELAY_GROUP names are made unique per hierarchy, whereas IODELAY_GROUP names can exist across hierarchies. Use HIODELAY_GROUP when:

- You have multiple instances of a module that contains an IDELAYCTRL, and
- You do not intend to group the specified instance with any IDELAY or ODELAY instances in other logical hierarchies.

Architecture Support

All architectures.

Applicable Objects

- Cells (`get_cells`)
 - IDELAY, ODELAY, or IDELAYCTRL instances

Values

Any specified group name

Syntax

Verilog Syntax

Place the Verilog attribute immediately before the instantiation of an IDELAY, ODELAY, or IDELAYCTRL.

```
(* HIODELAY_GROUP = "value" *)
```

Verilog Syntax Example

```
// Specifies a group name of DDR_INTERFACE to an instantiated IDELAYCTRL
// IDELAYCTRL: IDELAYE2/ODELAYE2 Tap Delay Value Control
// Virtex-7
// Xilinx HDL Language Template, version 2014.1
// Specifies DDR_INTERFACE group name for IDELAYs/ODELAYs and IDELAYCTRL
(* HIODELAY_GROUP = "DDR_INTERFACE" *)
IDELAYCTRL DDR_IDELAYCTRL_inst (
    .RDY(),           // 1-bit output: Ready output
    .REFCLK(REFCLK), // 1-bit input: Reference clock input
    .RST(1'b0)       // 1-bit input: Active-High reset input
);
// End of DDR_IDELAYCTRL_inst instantiation
```

VHDL Syntax

Declare the VHDL attribute as follows:

```
attribute HIODELAY_GROUP : string;
```

For an instantiated instance, specify the VHDL attribute as follows:

```
attribute HIODELAY_GROUP of instance_name : label is "group_name";
```

Where

- `instance_name` is the instance name of an instantiated IDELAY, ODELAY, or IDELAYCTRL.

VHDL Syntax Example

```
// Specifies a group name of DDR_INTERFACE to an instantiated IDELAYCTRL
attribute HIODELAY_GROUP : STRING;
attribute HIODELAY_GROUP of DDR_IDELAYCTRL_inst: label is "DDR_INTERFACE";
begin
    -- IDELAYCTRL: IDELAYE2/ODELAYE2 Tap Delay Value Control
    -- Virtex-7
    -- Xilinx HDL Language Template, version 2014.1
    DDR_IDELAYCTRL_inst : IDELAYCTRL
    port map (
        RDY => open,           -- 1-bit output: Ready output
        REFCLK => REFCLK,     -- 1-bit input: Reference clock input
        RST => '0'            -- 1-bit input: Active-High reset input
    );
```

```
-- End of DDR_IDELAYCTRL_inst instantiation
```

XDC Syntax

```
set_property HIODELAY_GROUP group_name [get_cells instance_name]
```

Where

- `instance_name` is the instance name of an IDELAY, ODELAY, or IDELAYCTRL.

XDC Syntax Example

```
# Specifies a group name of DDR_INTERFACE to an instantiated IDELAYCTRL  
set_property HIODELAY_GROUP DDR_INTERFACE [get_cells DDR_IDELAYCTRL_inst]
```

Affected Steps

- `place_design`

See Also

[IODELAY_GROUP](#), page 248

Refer to the following design elements in the *Vivado Design Suite 7 Series FPGA and Zynq-7000 SoC Libraries Guide* (UG953) [Ref 25] or the *UltraScale Architecture Libraries Guide* (UG974) [Ref 26].

- IDELAYCTRL
- IDELAYE2
- ODELAYE2

HLUTNM

By default the Vivado placer will group two LUTs with compatible inputs into a single LUT6 site to reduce resource utilization. The HLUTNM property lets you group two specific LUT5, SRL16, or LUTRAM components to place into the same LUT6 site by assigning the same `<group_name>`.

You can also use the **Disabled** value for the HLUTNM property on specific LUTs to prevent the Vivado placer from combining them with other LUTs. This is useful, for example, to prevent LUT combining for debug ILA and VIO cores, keeping probes available for later modification in the ECO flow. Refer to this [link](#) in the *Vivado Design Suite User Guide: Programming and Debugging* (UG908) [Ref 22] for more information on the ECO flow.

Difference Between HLUTNM and LUTNM



TIP: The HLUTNM property and the LUTNM property are similar in purpose, and should be assigned different values when used in the same level of hierarchy. The Vivado placer will combine LUTs that have the same LUTNM and HLUTNM values, or return warnings related to conflicting values.

- Use LUTNM to group two LUT components that exist anywhere in the design, including in different levels of the hierarchy.
- Use HLUTNM to group LUT components in a single hierarchical module, when you expect to have multiple instances of that module used in the design.
 - HLUTNM is uniquified per hierarchy.

Architecture Support

All architectures.

Applicable Objects

- Cells (`get_cells`)
 - LUT (LUT1, LUT2, LUT3, LUT4, LUT5)
 - SRL (SRL16E)
 - LUTRAM (RAM32X1S)

Values

- `<group_name>`: A unique group name to pack specified LUTs into the same LUT6 site.
- **Disabled**: Prevents the placer from grouping the specified LUT with another LUT during placement.

Syntax

Verilog Syntax

Place the Verilog attribute immediately before the instantiation of a LUT. The Verilog attribute must be used in pairs in the same logical hierarchy.

```
(* HLUTNM = "group_name" *)
```

Verilog Syntax Example

```
// Designates state0_inst to be placed in same LUT6 as state1_inst
// LUT5: 5-input Look-Up Table with general output (Mapped to a LUT6)
//      Virtex-7
// Xilinx HDL Language Template, version 2014.1
(* HLUTNM = "LUT_group1" *) LUT5 #(
    .INIT(32'h2a2aea2) // Specify LUT Contents
) state0_inst (
    .O(state_out[0]), // LUT general output
    .I0(state_in[0]), // LUT input
    .I1(state_in[1]), // LUT input
    .I2(state_in[2]), // LUT input
    .I3(state_in[3]), // LUT input
    .I4(state_in[4]) // LUT input
);
// End of state0_inst instantiation
// LUT5: 5-input Look-Up Table with general output (Mapped to a LUT6)
//      Virtex-7
// Xilinx HDL Language Template, version 2014.1
(* HLUTNM = "LUT_group1" *) LUT5 #(
    .INIT(32'h00330073) // Specify LUT Contents
) state1_inst (
    .O(state_out[1]), // LUT general output
    .I0(state_in[0]), // LUT input
    .I1(state_in[1]), // LUT input
    .I2(state_in[2]), // LUT input
    .I3(state_in[3]), // LUT input
    .I4(state_in[4]) // LUT input
);
// End of state1_inst instantiation
```

VHDL Syntax

Declare the VHDL attribute as follows:

```
attribute HLUTNM : string;
```

For an instantiated instance, specify the VHDL attribute as follows:

```
attribute HLUTNM of instance_name : label is "group_name";
```

Where:

- `instance_name` is a LUT1, LUT2, LUT3, LUT4, LUT5, SRL16, or LUTRAM instance.
- `group_name` is the name to assign to the HLUTNM property.

The VHDL attribute must be used in pairs in the same logical hierarchy.

VHDL Syntax Example

```
-- Designates state0_inst to be placed in same LUT6 as state1_inst
attribute HLUTNM : string;
attribute HLUTNM of state0_inst : label is "LUT_group1";
attribute HLUTNM of state1_inst : label is "LUT_group1";
begin
    -- LUT5: 5-input Look-Up Table with general output (Mapped to SLICEM LUT6)
    --      Virtex-7
    -- Xilinx HDL Language Template, version 2014.1
    state0_inst : LUT5
    generic map (
        INIT => X"a2a2aea2") -- Specify LUT Contents
    port map (
        O => state_out(0), -- LUT general output
        I0 => state_in(0), -- LUT input
        I1 => state_in(1), -- LUT input
        I2 => state_in(2), -- LUT input
        I3 => state_in(3), -- LUT input
        I4 => state_in(4)  -- LUT input
    );
    -- End of state0_inst instantiation
    -- LUT5: 5-input Look-Up Table with general output (Mapped to SLICEM LUT6)
    --      Virtex-7
    -- Xilinx HDL Language Template, version 2014.1
    State1_inst : LUT5
    generic map (
        INIT => X"00330073") -- Specify LUT Contents
    port map (
        O => state_out(1), -- LUT general output
        I0 => state_in(0), -- LUT input
        I1 => state_in(1), -- LUT input
        I2 => state_in(2), -- LUT input
        I3 => state_in(3), -- LUT input
        I4 => state_in(4)  -- LUT input
    );
    -- End of state1_inst instantiation
```

XDC Syntax

```
set_property HLUTNM <group_name> [get_cells <instance_name>]
```

Where

- <group_name>: Specifies a group name for the HLUTNM property.
- <instance_name>: Specifies the name of a LUT1, LUT2, LUT3, LUT4, LUT5, SRL16, or LUTRAM instance.

XDC Syntax Example

```
# Designates state0_inst LUT5 to be placed in same LUT6 as state1_inst
set_property HLUTNM LUT_group1 [get_cells state0_inst]
set_property HLUTNM LUT_group1 [get_cells state1_inst]
```

Affected Steps

- place_design

See Also

[LUTNM, page 277](#)

IBUF_LOW_PWR

The IBUF_LOW_PWR property allows an optional trade-off between performance and power.

The IBUF_LOW_PWR property is applied to an input port. This property is set to TRUE by default, which implements the input buffer for the port in the lower-power mode rather than the higher-performance mode (FALSE).

The change in power can be estimated using the Xilinx Power Estimator (XPE) or the `report_power` command in the Vivado Design Suite.

Architecture Support

All architectures.

Applicable Objects

- Input ports (`get_ports`) with a VREF-based I/O Standard such as SSTL or HSTL or a differential standard such as LVDS or DIFF_HSTL.

Values

- **TRUE:** Implements the input or bidirectional buffer for the port in low power mode. This is the default value.
- **FALSE:** Implements the input or bidirectional buffer in high performance mode.

Syntax

Verilog Syntax

For both inferred and instantiated input and bidirectional buffers, place the proper Verilog parameter syntax before the top-level port declaration.

```
(* IBUF_LOW_PWR = "FALSE" *)
```

Verilog Syntax Example

```
// Sets the input buffer to high performance
(* IBUF_LOW_PWR = "FALSE" *) input STATE,
```

VHDL Syntax

For both inferred and instantiated input buffers, place the proper VHDL attribute syntax before the top-level port declaration.

Declare and specify the VHDL attribute as follows:

```
attribute IBUF_LOW_PWR : boolean;  
attribute IBUF_LOW_PWR of port_name : signal is TRUE | FALSE;
```

Where:

- port_name is a top-level port.

VHDL Syntax Example

```
STATE : in std_logic;  
attribute IBUF_LOW_PWR : boolean;  
-- Sets the input buffer to high performance  
attribute IBUF_LOW_PWR of STATE : signal is FALSE;
```

XDC Syntax

IBUF_LOW_PWR can be assigned as a property on port objects with a DIRECTION of IN or INOUT.

```
set_property IBUF_LOW_PWR TRUE [get_ports port_name]
```

Where:

- set_property IBUF_LOW_PWR can be assigned to port objects.
- port_name is an input or bidirectional port.

Affected Steps

- report_power
- report_timing

See Also

[IOSTANDARD, page 251](#)

IN_TERM

IN_TERM specifies an uncalibrated input termination impedance value. The termination is present constantly on inputs, and on bidirectional pins whenever the output buffer is 3-stated.



IMPORTANT: For UltraScale architecture [ODT](#) is to be used instead of IN_TERM to specify uncalibrated termination.

IN_TERM is supported on High Range (HR) bank inputs only. For inputs in High Performance (HP) banks, specify a digitally controlled impedance (DCI) [IOSTANDARD](#) for on-chip termination.

While the 3-state split-termination DCI is calibrated against external reference resistors on the VRN and VRP pins, the IN_TERM property invokes an uncalibrated split-termination option using internal resistors that have no calibration to compensate for temperature, process, or voltage variations. This option has target Thevenin equivalent resistance values of 40Ω, 50Ω, and 60Ω. For more information refer to the *7 Series FPGAs SelectIO Resources User Guide* (UG471) [\[Ref 2\]](#).

Architecture Support

7 Series FPGAs on High Range (HR) bank inputs only.

Applicable Objects

- Input or bidirectional ports (`get_ports`)

Values

- NONE (default)
- UNTUNED_SPLIT_40
- UNTUNED_SPLIT_50
- UNTUNED_SPLIT_60

Syntax

Verilog Syntax

To set this attribute, place the proper Verilog attribute syntax before the top-level input or bidirectional port declaration.

```
(* IN_TERM = "{NONE|UNTUNED_SPLIT_40|UNTUNED_SPLIT_50|UNTUNED_SPLIT_60}" *)
```

Verilog Syntax Example

```
// Sets an on-chip input impedance of 50 Ohms to input ACT5  
(* IN_TERM = "UNTUNED_SPLIT_50" *) input ACT5,
```

VHDL Syntax

Declare the VHDL attribute as follows:

```
attribute IN_TERM : string;
```

Specify the VHDL attribute as follows:

```
attribute IN_TERM of port_name : signal is value;
```

Where

- port_name is a top-level input or bidirectional port.

VHDL Syntax Example

```
ACT5 : in std_logic;  
attribute IN_TERM : string;  
-- Sets an on-chip input impedance of 50 Ohms to input ACT5  
attribute IN_TERM of ACT5 : signal is "UNTUNED_SPLIT_50";
```

XDC Syntax

```
set_property IN_TERM value [get_ports port_name]
```

Where:

- IN_TERM can be assigned to port objects, and nets connected to port objects.
- port_name is an input or bidirectional port.

XDC Syntax Example

```
# Sets an on-chip input impedance of 50 Ohms to input ACT5  
set_property IN_TERM UNTUNED_SPLIT_50 [get_ports ACT5]
```

Affected Steps

- I/O Planning
- Report Noise
- Report Power

See Also

[DCI_CASCADE](#), page 185

[DIFF_TERM](#), page 188

INCREMENTAL_CHECKPOINT

The INCREMENTAL_CHECKPOINT property specifies the path and filename to a design checkpoint file (DCP) to be used during incremental implementation. Specify this property to reuse the placement and routing data of a previously placed or routed design. Refer to this [link](#) in the *Vivado Design Suite User Guide: Implementation (UG904)* [Ref 20] for more information.



TIP: The INCREMENTAL_CHECKPOINT property is only supported in the Vivado tools project-mode. To reuse prior placement and routing results in non-project mode use the `read_checkpoint -incremental` command.

The incremental implementation flow can be configured in one of three ways:

- Automatic reuse of the prior placement and routing of the current design. Enable the `AUTO_INCREMENTAL_CHECKPOINT` property.
- Manual reuse of the placement and routing data from a prior implementation of a specified design checkpoint. Disable the `AUTO_INCREMENTAL_CHECKPOINT` property, and specify the `INCREMENTAL_CHECKPOINT` property.
- Disabled so there is no incremental implementation. Disable the `AUTO_INCREMENTAL_CHECKPOINT` property, and do not specify the `INCREMENTAL_CHECKPOINT` property.

The reference design checkpoint is usually an earlier iteration or variation of the design that has been synthesized, placed, and routed. However, you can also reference a checkpoint that has placement only.



IMPORTANT: For the incremental flow to work properly, the device and speed grade of the reference design must match the device and speed grade of the current design.

Architecture Support

All architectures.

Applicable Objects

- Vivado implementation run objects (`get_runs`)

Values

- **{filename}**: Specifies the path and filename to a design checkpoint file (DCP) to be used during incremental implementation.

Syntax

Verilog and VHDL Syntax

Not applicable

XDC Syntax

```
set_property INCREMENTAL_CHECKPOINT {filename} [get_runs <impl_run> \  
-filter {IS_IMPLEMENTATION} ]
```

Where:

- *{filename}* is the path and filename of design checkpoint file (DCP) to be used during incremental implementation.



TIP: You can use the `-filter {IS_IMPLEMENTATION}` option for the `get_runs` command to get just implementation runs.

XDC Syntax Example

```
set_property INCREMENTAL_CHECKPOINT C:/Data/checkpoint_alpha.dcp \  
[get_runs * -filter {IS_IMPLEMENTATION}]
```

Affected Steps

- Implementation

See Also

[AUTO_INCREMENTAL_CHECKPOINT](#), page 147

INTERNAL_VREF

Single-ended I/O standards with a differential input buffer require an input reference voltage (VREF). When VREF is required within an I/O bank, you can use the dedicated VREF pin as an external VREF supply, or an internally generated VREF using the INTERNAL_VREF property, or for HP I/O banks on UltraScale devices use the VREF scan accessed through the HPIO_VREF primitive.

The INTERNAL_VREF property specifies the use of an internal regulator on an I/O bank to supply the voltage reference (VREF) for I/O standards requiring a reference voltage. Internally generated reference voltages remove the need to provide a particular VREF through a supply rail on the printed circuit board (PCB). This can reduce routing congestion on the system-level design.



TIP: Consider using the Internal Vref when the Xilinx device is the only device on the board/system requiring a particular VREF voltage supply level.

Refer to *7 Series FPGAs SelectIO Resources User Guide* (UG471) [Ref 2] or to *UltraScale Architecture SelectIO Resources User Guide* (UG571) [Ref 8] for more information.

Architecture Support

All architectures.

Applicable Objects

- I/O Bank (`get_iobanks`)

Values

- 0.60
- 0.675
- 0.7 (UltraScale only)
- 0.75
- 0.84 (UltraScale only)
- 0.90

Note: Not all values are supported in all types of I/O banks.

Syntax

Verilog and VHDL Syntax

Not applicable

XDC Syntax

```
set_property INTERNAL_VREF {value} [get_iobanks bank]
```

Where

- `value` is the reference voltage value.

XDC Syntax Example

```
# Designate Bank 14 to have a reference voltage of 0.75 Volts  
set_property INTERNAL_VREF 0.75 [get_iobanks 14]
```

Affected Steps

- I/O planning
- `place_design`
- DRC
- `report_power`

IO_BUFFER_TYPE

Apply `IO_BUFFER_TYPE` on a top level port to tell the tool to use IBUFs and OBUFs, or not to use input or output buffers. This attribute can be placed on any primary port or signal.

By default, Vivado synthesis infers input buffers for input ports, and infers output buffers for output ports. However, you can manually use the `IO_BUFFER_TYPE` property to disable this default behavior for specific ports or nets.



TIP: *The use of the `IO_BUFFER_TYPE` property implies a `KEEP` on the target net, which preserves the net name and prevents removing the net through RTL optimization.*

The `IO_BUFFER_TYPE` can be used in conjunction with the `CLOCK_BUFFER_TYPE` property to determine the combination of buffers to be inferred for clock signals.

Architecture Support

All architectures.

Applicable Objects

- Ports (`get_ports`): Apply `IO_BUFFER_TYPE` to any top-level port to disable buffer insertion.
- Nets (`get_nets`): Apply `IO_BUFFER_TYPE` to any signal connected to a top-level port to disable buffer insertion.

Values

- **NONE:** Specify this value on input or output ports. The presence of this property indicates that no input or output buffers are to be inferred.

Syntax

Verilog Example

```
(* io_buffer_type = "none" *) input in1;
```

VHDL Example

```
entity test is port(  
  in1 : std_logic_vector (8 downto 0);  
  clk : std_logic;  
  out1 : std_logic_vector(8 downto 0));  
  attribute io_buffer_type : string;  
  attribute io_buffer_type of out1: signal is "none";  
end test;
```

XDC Example

```
set_property IO_BUFFER_TYPE NONE [get_ports <port_name>]
```

Affected Steps

- Synthesis

See Also

[CLOCK_BUFFER_TYPE](#), page 164

IOB

IOB directs the Vivado tool to place a register that is connected to the specified port into the input or output logic block. Place this attribute on a port, connected to a register that you want to place into the I/O block.



IMPORTANT: *With this property set to TRUE, the Vivado placer will only place the register into the IOB. The tool will not move the flop out of the IOB to improve timing since the IOB constraint takes precedence.*

Architecture Support

All architectures.

Applicable Objects

- Ports (`get_ports`)
 - Any port connected to a register



TIP: *IOB can also be assigned to the register itself.*

Values

- **TRUE:** Place a connected register into the I/O Block.
- **FALSE:** Do not place the specified register into the I/O Block (default).

Syntax

Verilog Syntax

To set this attribute, place the proper Verilog attribute syntax before the top-level port declaration.

```
(* IOB = "{TRUE|FALSE}" *)
```

Verilog Syntax Example

```
// Place the register connected to ACK in the input logic site  
(* IOB = "TRUE" *) input ACK,
```

VHDL Syntax

Declare and specify the VHDL attribute as follows:

```
attribute IOB : string;  
attribute IOB of <port_name>: signal is "{TRUE|FALSE}";
```

Where:

- `port_name` is a top-level port.

VHDL Syntax Example

```
ACK : in std_logic;  
attribute IOB : string;  
-- Place the register connected to ACK in the input logic site  
attribute IOB of ACK: signal is "TRUE";
```

XDC Syntax

```
set_property IOB value [get_ports port_name]
```

Where

- `value` is TRUE or FALSE.

XDC Syntax Example

```
# Place the register connected to ACK in the input logic site  
set_property IOB TRUE [get_ports ACK]
```

Affected Steps

- `place_design`

IOB_TRI_REG

For UltraScale+ devices, the IOB_TRI_REG property tells the placer to place flip flops driving Tristate signals on High-density (HD) I/O banks in the I/O Logic (IOB) instead of the device fabric. Refer to the *UltraScale Architecture SelectIO Resources User Guide* (UG571) [Ref 8] for more information on High Density I/O.



TIP: This property must be assigned to the register cell as an XDC constraint, it is not supported in HDL source files, and cannot be assigned to the port.

Architecture Support

UltraScale+ devices.

Applicable Objects

- Cells (`get_cells`)

Values

- **TRUE:** Place the specified tristate register into the HD I/O Block.
- **FALSE:** Do not place the specified register into the I/O Block (default).

Syntax

Verilog Syntax

Not applicable.

VHDL Syntax

Not applicable.

XDC Syntax

```
set_property IOB_TRI_REG value [get_cells <cell_name>]
```

Affected Steps

- `place_design`

IOBDELAY

The Input Output Block Delay (IOBDELAY) property specifies whether to add or remove delay in the ILOGIC block in order to help mitigate input hold times for system-synchronous data input capture.

The ILOGIC block is located next to the I/O block (IOB), and contains the synchronous elements for capturing data as it comes into the FPGA through the IOB. The ILOGIC block in 7 series FPGAs can be configured as ILOGICE2 in HP I/O banks, and as ILOGICE3 in HR I/O banks. ILOGICE2 and ILOGICE3 are functionally identical except that ILOGICE3 has a zero hold delay element (ZHOLD) which can be configured with IOBDELAY. Refer to the *7 Series FPGAs SelectIO Resources User Guide* (UG471) [Ref 2] or the *UltraScale Architecture SelectIO Resources User Guide* (UG571) [Ref 8] for more information on the use of IOBDELAY.

Architecture Support

All architectures.

Applicable Objects

- Ports (`get_ports`)
- Cells, for assignment to input buffers (IBUFs).
- Nets

Values

- **NONE**: Sets the delay to OFF for both the IBUF and input flip-flop (IFD) paths.
- **IBUF**
 - Sets the delay to OFF for any register inside the I/O component.
 - Sets the delay to ON for the buffered path through the ILOGIC block.
- **IFD**
 - Sets the delay to ON for the IFF register inside the I/O component.
 - Sets the delay to OFF for the BUFFERED path through the ILOGIC.
- **BOTH**: Sets the delay to ON for both the IBUF and IFD paths.

Syntax

Verilog Example

Place the Verilog constraint immediately before the module or instantiation.

Specify the Verilog constraint as follows:

```
(* IOBDELAY = {NONE|BOTH|IBUF|IFD} *)
```

VHDL Example

Declare the VHDL constraint as follows:

```
attribute iobdelay: string;
```

Specify the VHDL constraint as follows:

```
attribute iobdelay of {component_name | label_name }: {component|label} is  
"{NONE|BOTH|IBUF|IFD}";
```

XDC Syntax

```
set_property IOBDELAY value [get_cells cell_name]
```

Where:

- value is one of NONE, IBUF, IFD, BOTH

XDC Syntax Example

```
set_property IOBDELAY "BOTH" [get_nets {data0_I}]
```

Affected Steps

- Timing
- Placement
- Routing

IODELAY_GROUP

IODELAY_GROUP groups IDELAYCTRL cells together with their associated IDELAY and ODELAY cells to allow proper placement and replication.

If you use IODELAY_GROUP to assign a group name to an IDELAYCTRL, you need to also associate an IDELAY or ODELAY cell to the group using the same IODELAY_GROUP property.



IMPORTANT: *While an IODELAY_GROUP can contain multiple cells, a cell can only be assigned to one IODELAY_GROUP.*

The following example uses `set_property` to group all the IDELAY/ODELAY elements associated with a specific IDELAYCTRL.

```
set_property IODELAY_GROUP IO_DLY1 [get_cells MY_IDELAYCTRL_inst]
set_property IODELAY_GROUP IO_DLY1 [get_cells MY_IDELAY_inst]
set_property IODELAY_GROUP IO_DLY1 [get_cells MY_ODELAY_inst]
```

Difference Between IODELAY_GROUP and HIODELAY_GROUP

IODELAY_GROUP can group elements across different hierarchies, whereas HIODELAY_GROUP names are made unique per hierarchy. Use IODELAY_GROUP to group I/O delay components from different hierarchies into a single group.

HIODELAY_GROUP groups I/O delay components under the same hierarchical module.

Architecture Support

All architectures.

Applicable Objects

- Cells (`get_cells`)
 - IDELAY, ODELAY, or IDELAYCTRL instances

Values

Any specified group name

Syntax

Verilog Syntax

Place the Verilog attribute immediately before the instantiation of an IDELAY, ODELAY, or IDELAYCTRL.

```
(* IDELAY_GROUP = "value" *)
```

Verilog Syntax Example

```
// Specifies a group name of DDR_INTERFACE to an instantiated IDELAYCTRL
// IDELAYCTRL: IDELAYE2/ODELAYE2 Tap Delay Value Control
//           Virtex-7
// Xilinx HDL Language Template, version 2014.1
// Specifies DDR_INTERFACE group name for IDELAYs/ODELAYs and IDELAYCTRL
(* IDELAY_GROUP = "DDR_INTERFACE" *)
IDELAYCTRL DDR_IDELAYCTRL_inst (
    .RDY(),           // 1-bit output: Ready output
    .REFCLK(REFCLK), // 1-bit input: Reference clock input
    .RST(1'b0)       // 1-bit input: Active-High reset input
);
// End of DDR_IDELAYCTRL_inst instantiation
```

VHDL Syntax

Declare the VHDL attribute as follows:

```
attribute IDELAY_GROUP : string;
```

For an instantiated instance, specify the VHDL attribute as follows:

```
attribute IDELAY_GROUP of instance_name : label is "group_name";
```

Where

- `instance_name` is the instance name of an instantiated IDELAY, ODELAY, or IDELAYCTRL.

VHDL Syntax Example

```
// Specifies a group name of DDR_INTERFACE to an instantiated IDELAYCTRL
attribute IDELAY_GROUP : STRING;
attribute IDELAY_GROUP of DDR_IDELAYCTRL_inst: label is "DDR_INTERFACE";
begin
    -- IDELAYCTRL: IDELAYE2/ODELAYE2 Tap Delay Value Control
    --           Virtex-7
    -- Xilinx HDL Language Template, version 2014.1
    DDR_IDELAYCTRL_inst : IDELAYCTRL
    port map (
        RDY => open,           -- 1-bit output: Ready output
        REFCLK => REFCLK,     -- 1-bit input: Reference clock input
        RST => '0'             -- 1-bit input: Active-High reset input
    );
```

```
-- End of DDR_IDELAYCTRL_inst instantiation
```

XDC Syntax

```
set_property IODELAY_GROUP group_name [get_cells instance_name]
```

Where

- `group_name` is a user-specified name for the IODELAY_GROUP.
- `instance_name` is the instance name of an IDELAY, ODELAY, or IDELAYCTRL.

XDC Syntax Example

```
# Specifies a group name of DDR_INTERFACE to an instantiated IDELAYCTRL
set_property IODELAY_GROUP DDR_INTERFACE [get_cells DDR_IDELAYCTRL_inst]
```

Affected Steps

- Placement

See Also

[HIODELAY_GROUP](#), page 225

Refer to the following design elements in the *Vivado Design Suite 7 Series FPGA and Zynq-7000 SoC Libraries Guide* (UG953) [Ref 25] or the *UltraScale Architecture Libraries Guide* (UG974) [Ref 26].

- IDELAYCTRL
- IDELAYE2
- ODELAYE2

IOSTANDARD

IOSTANDARD specifies which programmable I/O Standard to use to configure input, output, or bidirectional ports on the target device.



IMPORTANT: You must explicitly define an IOSTANDARD on all ports in an I/O Bank before Vivado Design Suite will create a bitstream from the design. However, IOSTANDARDS cannot be applied to GTs or XADCs.

You can mix different IOSTANDARDS in a single I/O Bank, however, the IOSTANDARDS must be compatible. The following rules must be followed when combining different input, output, and bidirectional I/O standards in a single I/O bank:

1. Output standards with the same output V_{CCO} requirement can be combined in the same bank.
2. Input standards with the same V_{CCO} and V_{REF} requirements can be combined in the same bank.
3. Input standards and output standards with the same V_{CCO} requirement can be combined in the same bank.
4. When combining bidirectional I/O with other standards, make sure the bidirectional standard can meet the first three rules.

Architecture Support

All architectures.

Applicable Objects

- Ports (`get_ports`)
 - Any port - Define the IOSTANDARD in the RTL source of I/O Ports, or as XDC constraints for port cells.

Values

There are many different valid I/O Standards for the target Xilinx FPGA. Refer to the *7 Series FPGAs SelectIO Resources User Guide* (UG471) [Ref 2] and the *UltraScale Architecture SelectIO Resources User Guide* (UG571) [Ref 8] for device specific IOSTANDARD values.

Syntax

Verilog Syntax

To set this parameter, place the proper Verilog syntax before the top-level port declaration.

```
(* IOSTANDARD = "value" *)
```

Verilog Syntax Example

```
// Sets the I/O Standard on the STATUS output to LVCMOS12
(* IOSTANDARD = "LVCMOS12" *) output STATUS,
```

VHDL Syntax

Place the proper VHDL attribute syntax before the top-level port declaration.

Declare and specify the VHDL attribute as follows:

```
attribute IOSTANDARD : string;
attribute IOSTANDARD of <port_name>: signal is "<standard>";
```

Where:

- `port_name` is a top-level port.

VHDL Syntax Example

```
STATUS : out std_logic;
attribute IOSTANDARD : string;
-- Sets the I/O Standard on the STATUS output to LVCMOS12
attribute IOSTANDARD of STATUS: signal is "LVCMOS12";
```

XDC Syntax

The IOSTANDARD can also be defined as an XDC constraint on port objects in the design.

```
set_property IOSTANDARD value [get_ports port_name]
```

Where

- `port_name` is a top-level port.

XDC Syntax Example

```
# Sets the I/O Standard on the STATUS output to LVCMOS12
set_property IOSTANDARD LVCMOS12 [get_ports STATUS]
```

Affected Steps

- I/O Planning
- Report Noise
- Report Power
- Report DRC
- place_design

See Also

Refer to the following design elements in the *Vivado Design Suite 7 Series FPGA and Zynq-7000 SoC Libraries Guide* (UG953) [Ref 25], or the *UltraScale Architecture Libraries Guide* (UG974) [Ref 26]:

- OBUF
- OBUFT
- IOBUF

IP_REPO_PATHS

This property lets you create a custom IP catalog for use with the Vivado Design Suite.

The IP_REPO_PATHS property defines the path to one or more directories containing third-party or user-defined IP. The specified directories, and any sub-directories, are searched for IP definitions to add to the Vivado Design Suite IP catalog for use in design entry or with the IP integrator.

The property is assigned to the current fileset of the current project.



TIP: To configure the Vivado Design Suite to assign the IP_REPO_PATHS property to each new project as it is created, you can use the **Tools > Settings** command in the Vivado IDE to set the default IP Repository Search Paths under the **IP Defaults** page. The default IP repository search path is stored in the `vivado.ini` file, and added to new projects using the IP_REPO_PATHS property.

The IP_REPO_PATHS looks for a `<component>.xml` file, where `<component>` is the name of the IP to add to the catalog. The XML file identifies the various files that define the IP. The IP_REPO_PATHS property does not have to point directly at the XML file for each IP in the repository. The IP catalog searches through the sub-folders of the specified IP repositories, looking for IP to add to the catalog.



IMPORTANT: You must use the `update_ip_catalog` command after setting the IP_REPO_PATHS property to have the new IP repository directories added to the IP catalog.

If the third-party or user-defined IP in the repository supports the product family of the device in use in the current project or design, the IP is added to the catalog as compatible IP. If the IP compatibility does not include the target part, the IP is not compatible with the current project or design and may not be visible in the IP catalog. Refer to the *Vivado Design Suite User Guide: Designing with IP* (UG896) [Ref 16] for more information.

Architecture Support

UltraScale devices.

Applicable Objects

- `current_fileset`

Values

- `<dir_name>` - Specify one or more directory names where user-defined IP are stored. Directory names can be specified as relative or absolute, should be separated, or delimited by a space, and should be enclosed in braces, {}, or quotes, "".

Syntax

Verilog and VHDL Syntax

Not applicable

XDC Syntax

```
set_property IP_REPO_PATHS {<ip_directories>} [current_fileset]
```

Where:

- <ip_directories> specifies one or more directories containing third-party or user-defined packaged IP definitions.

XDC Syntax Example

```
set_property IP_REPO_PATHS {c:/Data/Designs C:/myIP} [current_fileset]  
update_ip_catalog
```

Applicable Steps

- Design Entry

IS_ENABLED

The IS_ENABLED property lets you enable or disable individual design rule checks (DRC) in the Vivado Design Suite when running Report DRC. For more information on Running DRCs, see this [link](#) in the *Vivado Design Suite User Guide: System-Level Design Entry* (UG895) [Ref 15].

You can enable or disable both built-in and custom DRCs. For information on writing custom design rule checks, see this [link](#) in the *Vivado Design Suite User Guide: Using Tcl Scripting* (UG894) [Ref 14].



IMPORTANT: *Although Vivado allows you to disable and downgrade the severity of the built-in DRC Objects, this practice is highly discouraged as it can cause unpredictable results and could potentially cause permanent damage to the device.*

To restore the DRC objects to the factory default setting, use the [reset_drc_check](#) Tcl command.

Architecture Support

All architectures.

Applicable Objects

- Design Rule Check objects ([get_drc_checks](#))

Values

- **TRUE:** Enable the specified DRC for use during the report_drc command (default).
- **FALSE:** Disable the DRC so that the rule is not evaluated during report_drc.

Syntax

Verilog and VHDL Syntax

Not applicable

XDC Syntax

```
set_property IS_ENABLED {TRUE | FALSE} [get_drc_checks <id>]
```

Where:

- `<id>` is the DRC ID recognized by the Vivado Design Suite.

XDC Syntax Example

```
set_property IS_ENABLED false [get_drc_checks RAMW-1]
```

Affected Steps

- report_drc
- write_bitstream

See Also

[SEVERITY](#), page 344

KEEP

Use the KEEP attribute to prevent optimizations. Where signals are optimized or absorbed into logic blocks, the KEEP attribute instructs the synthesis tool to keep the signal it was placed on, and extract that signal to the netlist.

For example, if a signal is an output of a 2-bit AND gate, and it drives another AND gate, the KEEP attribute can be used to prevent that signal from being merged into a larger LUT that encompasses both AND gates.

KEEP is also commonly used in conjunction with timing constraints. If there is a timing constraint on a signal that would normally be optimized, KEEP prevents that and allows the correct timing rules to be used.

However, you should use care not to put KEEP on signals that do not drive anything. Synthesis will preserve those signals, and they may cause problems in downstream processes.

Note: KEEP is not supported on the port of a module or entity. If specific ports are needed to be kept, either use the `flatten_hierarchy = "none"` setting, or put a DONT_TOUCH on the module or entity itself.



CAUTION! *Be careful when using KEEP with other attributes. In cases where other attributes are in conflict with KEEP, the KEEP attribute usually takes precedence.*

Examples:

- When you have a MAX_FANOUT attribute on one signal and a KEEP attribute on a second signal that is driven by the first; the KEEP attribute on the second signal would not allow fanout replication.
- With a RAM STYLE="block", when there is a KEEP on the register that would need to become part of the RAM, the KEEP attribute prevents the block RAM from being inferred.

Architecture Support

All architectures.

Applicable Objects

- You can place this attribute on any signal, register, or wire.
 - `get_nets`
 - `get_cells`

Values

- **TRUE:** Keeps the signal.
- **FALSE:** Allows the Vivado synthesis to optimize, if the tool makes that determination. The FALSE value does not force the tool to remove the signal. The default value is FALSE.



RECOMMENDED: *Set this attribute in the RTL only. Because signals that need to be kept are often optimized before the XDC file is read, setting this attribute in the RTL ensures that the attribute is used.*

Syntax

The syntax examples in this section show how to use this constraint with particular tools or methods. If a tool or method is not listed, you cannot use this constraint with it.

Verilog Syntax

Place the Verilog constraint immediately before the module or instantiation.

Specify the Verilog constraint as follows:

```
(* KEEP = "{TRUE|FALSE|SOFT}" *)
```

Verilog Example

```
(* keep = "true" *) wire sig1;  
assign sig1 = in1 & in2;  
assign out1 = sig1 & in2;
```

VHDL Syntax

Declare the VHDL constraint as follows:

```
attribute keep : string;
```

Specify the VHDL constraint as follows:

```
attribute keep of signal_name : signal is "{TRUE|FALSE}";
```

VHDL Example

```
signal sig1 : std_logic;  
attribute keep : string;  
attribute keep of sig1 : signal is "true";  
....  
....  
sig1 <= in1 and in2;  
out1 <= sig1 and in3;
```

XDC Syntax

Not applicable

Applicable Steps

- Synthesis

See Also

[DONT_TOUCH](#), page 197

[KEEP_HIERARCHY](#), page 263

[MARK_DEBUG](#), page 285

KEEP_COMPATIBLE

During the FPGA design process, you can change the target device when a design decision calls for a larger or different part. The KEEP_COMPATIBLE property defines a list of one or more Xilinx FPGA parts that the current design should be compatible with to permit targeting the design on a different device as needed. This will allow the design to be mapped onto the current part, or any of the compatible parts by preventing the use of IO or PACKAGE_PINS that are not compatible between the specified devices.

The KEEP_COMPATIBLE property lets you define alternate compatible devices early in the design flow so that I/O pin assignments will work across the specified list of compatible devices. The Vivado Design Suite defines package pin PROHIBIT properties to prevent assignment of I/O ports to pins that are not common to all the parts.

Architecture Support

All architectures.

Applicable Objects

- current_design

Values

COMPATIBLE_PARTs are defined by a combination of the device and the package of the current target part. For example, the xc7k70tfbg676-2 part has the following properties:

```
NAME xc7k325tffg676-2
DEVICE xc7k325t
PACKAGE ffg676
COMPATIBLE_PARTS xc7k160tfbg676 xc7k160tffg676 xc7k325tfbg676
                  xc7k410tfbg676 xc7k410tffg676 xc7k70tfbg676
```

The COMPATIBLE_PARTS property of the part object lists variations of the DEVICE and the PACKAGE, without specifying the SPEED. This results in the following compatible parts:

```
xc7k160tfbg676-1
xc7k160tfbg676-2
xc7k160tfbg676-2L
xc7k160tfbg676-3
xc7k160tffg676-1
xc7k160tffg676-2
xc7k160tffg676-2L
xc7k160tffg676-3
xc7k325tfbg676-1
xc7k325tfbg676-2
xc7k325tfbg676-2L
xc7k325tfbg676-3
xc7k410tfbg676-1
```

```
xc7k410tffg676-2
xc7k410tffg676-2L
xc7k410tffg676-3
xc7k410tffg676-1
xc7k410tffg676-2
xc7k410tffg676-2L
xc7k410tffg676-3
xc7k70tffg676-1
xc7k70tffg676-2
xc7k70tffg676-2L
xc7k70tffg676-3
```

Syntax

Verilog and VHDL Syntax

Not applicable

XDC Syntax

```
set_property KEEP_COMPATIBLE {value1 value2 valueN} [current_design]
```

Where {value1 value2 valueN} is one or more of the COMPATIBLE_PARTS as defined on the PART object. The COMPATIBLE_PARTS for the target part of the current design can be obtained using the following Tcl command:

```
get_property COMPATIBLE_PARTS [get_property PART [current_design]]
```

XDC Syntax Example

```
set_property KEEP_COMPATIBLE {xc7k160tffg676 xc7k410tffg676} [current_design]
```

Applicable Steps

- I/O Planning
- Placement

KEEP_HIERARCHY

KEEP_HIERARCHY directs the tool to retain a user hierarchy so that optimization does not occur across its boundary. While this can assist floorplanning, analysis, and debugging, it may inhibit optimization, resulting in a larger, slower design.



RECOMMENDED: *To avoid these negative effects, register all outputs of a module instance in which a KEEP_HIERARCHY is attached. To be most effective, apply this attribute before synthesis.*

KEEP_HIERARCHY is used to prevent optimizations along the hierarchy boundaries. The Vivado synthesis tool attempts to keep the same general hierarchies specified in the RTL, but to improve quality of results (QoR), it can flatten or modify them.

If KEEP_HIERARCHY is placed on the instance, the synthesis tool keeps the boundary on that level static. This can affect QoR and also should not be used on modules that describe the control logic of 3-state outputs and I/O buffers. The KEEP_HIERARCHY can be placed in the module or architecture level or the instance.

Architecture Support

All.

Applicable Objects

- Hierarchical modules (`get_cells`)

Values

- **TRUE:** Preserves the hierarchy by not allowing optimization across the hierarchy boundary.
- **FALSE:** Allows optimization across the hierarchy (default).

Syntax

Verilog Syntax

Place the Verilog attribute immediately before the user hierarchy instantiation:

```
(* KEEP_HIERARCHY = "{TRUE|FALSE}" *)
```

Verilog Syntax Example

```
// Preserve the hierarchy of instance CLK1_rst_sync
(* KEEP_HIERARCHY = "TRUE" *) reset_sync #(
    .STAGES(5)
) CLK1_rst_sync (
    .RST_IN(RST | ~LOCKED),
    .CLK(clk1_100mhz),
    .RST_OUT(rst_clk1)
);
```

On Module:

```
(* keep_hierarchy = "yes" *) module bottom (in1, in2, in3, in4, out1, out2);
```

On Instance:

```
(* keep_hierarchy = "yes" *)bottom u0 (.in1(in1), .in2(in2), .out1(temp1));
```

VHDL Syntax

Declare the VHDL attribute as follows:

```
attribute KEEP_HIERARCHY : string;
```

Specify the VHDL attribute as follows:

```
attribute KEEP_HIERARCHY of name: label is "{TRUE|FALSE}";
```

Where

- name is the instance name of a user defined instance.

VHDL Syntax Example

```
attribute KEEP_HIERARCHY : string;
-- Preserve the hierarchy of instance CLK1_rst_sync
attribute KEEP_HIERARCHY of CLK1_rst_sync: label is "TRUE";
...
CLK1_rst_sync : reset_sync
    PORT MAP (
        RST_IN => RST_LOCKED,
        CLK => clk1_100mhz,
        RST_OUT => rst_clk1
    );
```

On a module:

```
attribute keep_hierarchy : string;  
attribute keep_hierarchy of beh : architecture is "yes";
```

On an instance:

```
attribute keep_hierarchy : string;  
attribute keep_hierarchy of u0 : label is "yes";
```

XDC Syntax

```
set_property KEEP_HIERARCHY {TRUE|FALSE} [get_cells instance_name]
```

Where

- `instance_name` is a hierarchical module.

XDC Syntax Example

```
# Preserve the hierarchy of instance CLK1_rst_sync  
set_property KEEP_HIERARCHY TRUE [get_cells CLK1_rst_sync]
```

Affected Steps

- `synth_design`

See Also

[DONT_TOUCH](#), page 197

[KEEP](#), page 258

[MARK_DEBUG](#), page 285

KEEPER



IMPORTANT: *The KEEPER property has been deprecated and should be replaced by [PULLTYPE](#).*

KEEPER applies a weak driver on a tri-stateable output or bidirectional port to preserve its value when not being driven. The KEEPER property retains the value of the output net to which the port is attached.

For example, if logic 1 is being driven through the specified port, KEEPER drives a weak or resistive 1 through the port. If the net driver is then tri-stated, KEEPER continues to drive a weak or resistive 1 onto the net, through the connected port, to preserve that value.

Input buffers (e.g., IBUF), 3-state output buffers (e.g., OBUFT), and bidirectional buffers (e.g., IOBUF) can have a weak pull-up resistor, a weak pull-down resistor, or a weak “keeper” circuit. This feature can be invoked by adding the PULLTYPE property with one of the following values to the port object connected to the buffer:

- PULLUP
- PULLDOWN
- KEEPER

Note: When this attribute is applied, the KEEPER functionality will not be shown during RTL simulation which may create a functional difference between RTL simulation and the implemented design. This functionality can be verified using a gate-level simulation netlist or else the PULLDOWN UNISIM may be instantiated in the design in place of using this property in order to reflect this behavior in the RTL simulation.

Architecture Support

All.

Applicable Objects

- Ports (`get_ports`): Apply to any top-level port.

Values

- **TRUE|YES:** Use a keeper circuit to preserve the value on the net connected to the specified port.
- **FALSE|NO:** Do not use a keeper circuit (default).

Syntax

Verilog Syntax

Place the Verilog constraint immediately before port definition.

Specify the Verilog constraint as follows:

```
(* KEEPER = " {YES|NO|TRUE|FALSE}" *)
```

VHDL Syntax

Declare and specify the VHDL constraint as follows:

```
attribute keeper: string;  
attribute keeper of signal_name : signal is "{YES|NO|TRUE|FALSE}";
```

XDC Syntax

```
set_property KEEPER {TRUE|FALSE} [get_ports port_name]
```

Where

- port_name is the name of an input, output, or inout port.

XDC Syntax Example

```
# Use a keeper circuit to preserve the value on the specified port  
set_property KEEPER TRUE [get_ports wbWriteOut]
```

Affected Steps

- Logical to Physical Mapping

See Also

[PULLDOWN](#), page 317

[PULLTYPE](#), page 319

[PULLUP](#), page 322

LOC

LOC specifies the placement assignment of a logic cell to the SITE resources of the target Xilinx part.

The LOC property or constraint is sometimes used with the [BEL](#) property to define the exact placement of cells within the device. In these cases the BEL constraint must be defined before the LOC constraint, or a placement error will occur.



TIP: To assign I/O ports to physical pins on the device package, use the [PACKAGE_PIN](#) property rather than LOC.

Architecture Support

All architectures.

Applicable Objects

- Cells (`get_cells`)
 - Any primitive cell

Values

Site name (for example, SLICE_X15Y14 or RAMB18_X6Y9)

Syntax

Verilog Syntax

Place the Verilog attribute immediately before the instantiation of a component.



TIP: The Verilog attribute can also be placed before the `reg` declaration of an inferred register, SRL, or LUTRAM when that `reg` can be placed into a single device site:

```
(* LOC = "site_name" *)
// Designates placed_reg to be placed in SLICE site SLICE_X0Y0
(* LOC = "SLICE_X0Y0" *) reg placed_reg;
```

VHDL Syntax

Declare the VHDL attribute as follows:

```
attribute LOC : string;
```

For an instantiated instance, specify the VHDL attribute as follows:

```
attribute LOC of instance_name : label is "site_name";
```

Where `instance_name` is the instance name of an instantiated primitive.

VHDL Syntax Example

```
-- Designates instantiated register instance placed_reg to be placed
-- in SLICE site SLICE_X0Y0
attribute LOC of placed_reg : label is "SLICE_X0Y0";
```

For an inferred instance, specify the VHDL attribute as follows:

```
attribute LOC of signal_name : signal is "site_name";
```

Where

- `signal_name` is the signal name of an inferred primitive that can be placed into a single site.

VHDL Syntax Example

```
-- Designates inferred register placed_reg to be placed in SLICE site SLICE_X0Y0
attribute LOC of placed_reg : signal is "SLICE_X0Y0";
```

XDC Syntax

```
set_property LOC site_name [get_cells instance_name]
```

Where

- `instance_name` is a primitive instance.

XDC Syntax Example

```
# Designates placed_reg to be placed in SLICE site SLICE_X0Y0
set_property LOC SLICE_X0Y0 [get_cells placed_reg]
```

Affected Steps

- Design Floorplanning
- place_design

See Also

[BEL](#), page 149

[PACKAGE_PIN](#), page 296

[PBLOCK](#), page 300

LOCK_PINS

LOCK_PINS is a cell property used to specify the mapping of logical LUT inputs (I0, I1, I2, ...) to physical LUT inputs (A6, A5, A4, ...) on the Xilinx FPGA resource. A common use is to force timing-critical LUT inputs to be mapped to the fastest A6 and A5 physical LUT inputs.

By default, LUT pins are mapped in order from highest to lowest. The highest logical pin is mapped to the highest physical pin.

- ALUT6 placed on an A6LUT bel, would have a default pin mapping of:

```
I5:A6 I4:A5 I3:A4 I2:A3 I1:A2 I0:A1
```

- A LUT5 placed on a D5LUT bel, would have a default pin mapping of:

```
I5:A5 I4:A4 I3:A3 I2:A2 I1:A1
```

- A LUT2 placed on an A6LUT bel, would have a default pin mapping of:

```
I1:A6 I0:A5
```

The LOCK_PINS property is used by the Vivado router, which will not modify pin mappings on locked LUTs even if it would result in improved timing. LOCK_PINS is also important for directed routing. If a pin that is connected by a directed route, is swapped with another pin, the directed route will no longer align with the LUT connection, resulting in an error. All LUT cells driven by a directed route net should have their pins locked using LOCK_PINS. Refer to the *Vivado Design Suite User Guide: Implementation* (UG904) [Ref 20] for more information on directed routing.

Note: DONT_TOUCH does not imply LOCK_PINS.

When running the `phys_opt_design -critical_pin_opt` optimization, a cell with the LOCK_PINS property is not optimized, and the pin mapping specified by LOCK_PINS is retained. Refer to the *Vivado Design Suite Tcl Command Reference Guide* (UG835) [Ref 13] for more information on the `phys_opt_design` command.

When the LOCK_PINS property is removed from a cell, the pin mapping is cleared and the pins are free to be swapped. However, there is no immediate change to the current pin assignments.

Architecture Support

All architectures.

Applicable Objects

- LUT Cells (`get_cells`)

Values

- LOCK_PINS { I0:A6 I1:A5 }: One or more pin mapping pairs, assigning LUT logical pins to LUT physical pins using logical-to-physical pin map pairs.
 - The LOCK_PINS value syntax is an unordered list of pin mappings, separated by commas in HDL, or by white space in XDC.
 - The list of possible instance pins ranges from I0 for a LUT1, to I0 through I5 for a LUT6. The physical pins range from A6 (fastest) to A1 for a 6LUT and A5 (fastest) to A1 for a 5LUT.



TIP: The ISE supported values of ALL, or no value to imply ALL, are not supported in the Vivado Design Suite. To lock ALL pins, each pin must be explicitly specified. Any unlisted logical pins are mapped to a physical pin using the default mapping.

Syntax

Verilog Syntax

LOCK_PINS values can be assigned as a Verilog attribute placed on instantiated LUT cells (e.g. LUT6, LUT5, etc).

The following example defines LOCK_PINS with pin mapping logical I1 to A5, and logical I2 to A6, on a LUT cell LUT_inst_0:

```
(* LOCK_PINS = "I1:A5, I2:A6" *) LUT6 #(.INIT(64'h1) ) LUT_inst_0 ( . . .
```

Verilog Example

```
module top (
    i0,
    i1,
    i2,
    i3,
    i4,
    i5,
    o0);
    input i0;
    input i1;
    input i2;
    input i3;
    input i4;
    input i5;
    output o0;

    (* LOCK_PINS = "I1:A5,I2:A6" *)
    LUT6 #(
        .INIT(64'h0000000000000001))
        LUT_inst_0
        (.I0(i0),
         .I1(i1),
```

```

        .I2(i2),
        .I3(i3),
        .I4(i4),
        .I5(i5),
        .O(o0));
endmodule

```

VHDL Syntax

LOCK_PINS values can be assigned as a VHDL attribute placed on instantiated LUT cells (e.g. LUT6, LUT5, etc).

The following example defines LOCK_PINS with pin mapping logical I1 to A5, and logical I2 to A6, on a LUT cell LUT_inst_0:

```

attribute LOCK_PINS : string;
attribute LOCK_PINS of LUT_inst_0 : label is "I1:A5, I2:A6";
. . .

```

VHDL Example:

```

entity top is port (
    i0, i1, i2, i3, i4, i5 : in std_logic;
    o0 : out std_logic
);
end entity top;

architecture struct of top is

attribute lock_pins : string;
attribute lock_pins of LUT_inst_0 : label is "I1:A5, I2:A6";

begin
    LUT_inst_0 : LUT6 generic map (
        INIT => "1"
    ) port map (
        I0 => i0,
        I1 => i1,
        I2 => i2,
        I3 => i3,
        I4 => i4,
        I5 => i5,
        O => o0
    );
end architecture struct;

```

XDC Syntax

The LOCK_PINS property can be set on LUT cells using the set_property Tcl command in the Vivado Design Suite:

```

set_property LOCK_PINS {pin pairs} [get_cells instance_name]

```

Where:

- `instance_name` is one or more LUT cells.



IMPORTANT: *XDC requires white space separation between pin pairs to satisfy the Tcl list syntax, while HDL syntax requires comma-separated values.*

XDC Syntax Example

```
% set myLUT2 [get_cells u0/u1/i_365]
% set_property LOCK_PINS {I0:A5 I1:A6} $myLUT2
% get_property LOCK_PINS $myLUT2
I0:A5 I1:A6
% reset_property LOCK_PINS $myLUT2
% set myLUT6 [get_cells u0/u1/i_768]
% set_property LOCK_PINS I0:A6 ; # mapping of I1 through I5 are dont-cares
```

Affected Steps

- `phys_opt_design`
- `route_design`

See Also

[BEL, page 149](#)

[DONT_TOUCH, page 197](#)

[LOC, page 268](#)

LOCK_UPGRADE

Often, users want IP that was validated in the previous release to be not upgraded. It is possible to selectively upgrade some IP within a block design. There are some limitations to this flow that a user must understand. This section describes the process to selectively upgrade IP, the requirements the consequences of doing so, and the limitations to this flow.

The LOCK_UPGRADE property lets you specify certain cells or IP in a block design to prevent those cells or IP from being upgraded.

It may be that you have validated the IP in a prior release, and you have all of the required output products, and you want to work with that content without upgrading to the latest version of the IP. With the LOCK_UPGRADE property you can select specific IP to be excluded from the upgrade process.

However, there are some limitations to this flow that you should understand. Refer to the section on “Selectively Upgrading IP in Block Designs” in *Vivado Design Suite User Guide: Designing IP Subsystems Using IP Integrator* (UG994) [Ref 27] to learn the requirements of this flow, and to “Limitations of Selectively Upgrading IP in Block Designs” to learn the limitations.

Architecture Support

All architectures.

Applicable Objects

- Block diagram cells (get_bd_cells)

Values

- **TRUE | 1**: Lock the specified block design cell or IP to prevent it from being upgraded as part of the rest of the block design.
- **FALSE | 0**: Do not lock the block design cell to prevent upgrading (default).

Syntax

Verilog and VHDL Syntax

Not applicable

XDC Syntax

```
set_property LOCK_UPGRADE <TRUE | FALSE> [get_bd_cells cell_name]
```

XDC Example

```
set_property LOCK_UPGRADE 1 [get_bd_cells /axi_ethernet_0]
```

Affected Steps

- IP upgrade

See Also

LUTNM

By default the Vivado placer will group two LUTs with compatible inputs into a single LUT6 site to reduce resource utilization. The LUTNM property lets you group two specific LUT5, SRL16, or LUTRAM components to place into the same LUT6 site by assigning the same `<group_name>`.

You can also use the **Disabled** value for the LUTNM property on specific LUTs to prevent the Vivado placer from combining them with other LUTs. This is useful, for example, to prevent LUT combining for debug ILA and VIO cores, keeping probes available for later modification in the ECO flow. Refer to this [link](#) in the *Vivado Design Suite User Guide: Programming and Debugging* (UG908) [Ref 23] for more information on the ECO flow.

Difference Between HLUTNM and LUTNM



TIP: The HLUTNM property and the LUTNM property are similar in purpose, and should be assigned different values when used in the same level of hierarchy. The Vivado placer will combine LUTs that have the same LUTNM and HLUTNM values, or return warnings related to conflicting values.

- Use LUTNM to group two LUT components that exist anywhere in the design, including in different levels of the hierarchy.
- Use HLUTNM to group LUT components in a single hierarchical module, when you expect to have multiple instances of that module used in the design.
 - HLUTNM is uniquified per hierarchy.

Architecture Support

All architectures.

Applicable Objects

- Cells (`get_cells`)
 - LUT (LUT1, LUT2, LUT3, LUT4, LUT5)
 - SRL (SRL16E)
 - LUTRAM (RAM32X1S)

Values

- `<group_name>`: A unique group name to pack specified LUTs into the same LUT6 site.
- **Disabled**: Prevents the placer from grouping the specified LUT with another LUT during placement.

Syntax

Verilog Syntax

Place the Verilog attribute immediately before the instantiation of a LUT. The Verilog attribute must be used in pairs in the same logical hierarchy.

```
(* LUTNM = "group_name" *)
```

Verilog Syntax Example

```
// Designates state0_inst to be placed in same LUT6 as state1_inst
// LUT5: 5-input Look-Up Table with general output (Mapped to a LUT6)
(* LUTNM = "LUT_group1" *) LUT5 #(
    .INIT(32'ha2a2aea2) // Specify LUT Contents
) state0_inst (
    .O(state_out[0]), // LUT general output
    .I0(state_in[0]), // LUT input
    .I1(state_in[1]), // LUT input
    .I2(state_in[2]), // LUT input
    .I3(state_in[3]), // LUT input
    .I4(state_in[4]) // LUT input
);
// End of state0_inst instantiation
// LUT5: 5-input Look-Up Table with general output (Mapped to a LUT6)
// Virtex-7
// Xilinx HDL Language Template, version 2014.1
(* LUTNM = "LUT_group1" *) LUT5 #(
    .INIT(32'h00330073) // Specify LUT Contents
) state1_inst (
    .O(state_out[1]), // LUT general output
    .I0(state_in[0]), // LUT input
    .I1(state_in[1]), // LUT input
    .I2(state_in[2]), // LUT input
    .I3(state_in[3]), // LUT input
    .I4(state_in[4]) // LUT input
);
// End of state1_inst instantiation
```

VHDL Syntax

Declare the VHDL attribute as follows:

```
attribute LUTNM : string;
```

For an instantiated instance, specify the VHDL attribute as follows:

```
attribute LUTNM of instance_name : label is "group_name";
```

Where:

- `instance_name` is a LUT1, LUT2, LUT3, LUT4, LUT5, SRL16, or LUTRAM instance.
- `group_name` is the name to assign to the HLUTNM property.

The VHDL attribute must be used in pairs in the same logical hierarchy.

VHDL Syntax Example

```
-- Designates state0_inst to be placed in same LUT6 as state1_inst
attribute LUTNM : string;
attribute LUTNM of state0_inst : label is "LUT_group1";
attribute LUTNM of state1_inst : label is "LUT_group1";
begin
    -- LUT5: 5-input Look-Up Table with general output (Mapped to SLICEM LUT6)
    state0_inst : LUT5
    generic map (
        INIT => X"a2a2aea2") -- Specify LUT Contents
    port map (
        O => state_out(0), -- LUT general output
        I0 => state_in(0), -- LUT input
        I1 => state_in(1), -- LUT input
        I2 => state_in(2), -- LUT input
        I3 => state_in(3), -- LUT input
        I4 => state_in(4)  -- LUT input
    );
    -- End of state0_inst instantiation
    -- LUT5: 5-input Look-Up Table with general output (Mapped to SLICEM LUT6)
    -- Virtex-7
    -- Xilinx HDL Language Template, version 2014.1
    state1_inst : LUT5
    generic map (
        INIT => X"00330073") -- Specify LUT Contents
    port map (
        O => state_out(1), -- LUT general output
        I0 => state_in(0), -- LUT input
        I1 => state_in(1), -- LUT input
        I2 => state_in(2), -- LUT input
        I3 => state_in(3), -- LUT input
        I4 => state_in(4)  -- LUT input
    );
    -- End of state1_inst instantiation
```

XDC Syntax

```
set_property LUTNM group_name [get_cells instance_name]
```

Where:

- `group_name` is the name to assign to the HLUTNM property.
- `instance_name` is a LUT1, LUT2, LUT3, LUT4, LUT5, SRL16, or LUTRAM instance.

XDC Syntax Example

```
# Designates state0_inst LUT5 to be placed in same LUT6 as state1_inst
set_property LUTNM LUT_group1 [get_cells U1/state0_inst]
set_property LUTNM LUT_group1 [get_cells U2/state1_inst]
```

Disabled XDC Example

```
set_property LUTNM "DISABLED" [get_cells -of \
[get_pins -leaf -filter DIRECTION==IN -of [get_pins ila_0/probe*]]]
```

Affected Steps

- `place_design`

See Also

[HLUTNM, page 228](#)

LUT_REMAP

The `opt_design -remap` option combines multiple LUTs into a single LUT to reduce the depth of the logic. Remap optimization can also combine LUTs that belong to different levels of the logical hierarchy.

Remapped logic is combined into the LUT that is furthest downstream in the logic cone.

The LUT_REMAP property lets you perform selective LUT remapping by applying the property to sequential LUT pairs to direct `opt_design` to merge them into a single LUT. Chains of LUTs with LUT_REMAP properties are collapsed into fewer logic levels where possible.



TIP: Setting the LUT_REMAP property to FALSE does not prevent LUTs from getting remapped when running `opt_design` with the `-remap` option. To prevent LUTs from being remapped, apply the DONT_TOUCH property with a value of true.

Refer to the *Vivado Design Suite User Guide: Implementation* (UG904) [Ref 20] for more information on optimization.

Architecture Support

- All architectures.

Applicable Objects

- LUT Cells (`get_cells`)

Value

- **TRUE | 1**
 - If `opt_design -remap` is called, the presence of the LUT_REMAP property with a value of TRUE has no additional effect.
 - If `opt_design -remap` is not called, the presence of the LUT_REMAP property with a value of TRUE on specific cells will call LUT remapping only for those specific cells during `opt_design`.
- **FALSE | 0:** This setting has no effect as it does not prevent the LUT from being remapped.

Syntax

Verilog and VHDL Syntax

Not applicable

XDC Syntax

```
set_property LUT_REMAP <value> <objects>
```

XDC Syntax Example

The following assigns the LUT_REMAP property to the specified LUT primitives:

```
set_property LUT_REMAP 1 [get_cells usbEngine*/* -filter {ref_name =~ LUT*}]
```

Affected Steps

- Logic Optimization (opt_design)

See Also

[CARRY_REMAP](#), page 157

[DONT_TOUCH](#), page 197

[MUXF_REMAP](#), page 290

LVDS_PRE_EMPHASIS

On UltraScale devices, the LVDS_PRE_EMPHASIS property is used to improve signal integrity of high-frequency signals that suffer high-frequency losses through the transmission line.

LVDS Transmitter pre-emphasis provides a voltage boost (gain) at the signal transitions to compensate for transmission-line losses on the drivers implementing certain I/O standards. Pre-emphasis for DDR4 HP I/O banks and LVDS TX HP/HR I/O banks is available to reduce inter-symbol interference and to minimize the effects of transmission line loss.



TIP: Pre-emphasis at the transmitter can be combined with [EQUALIZATION](#) at the receiver to improve the overall signal integrity.

The pre-emphasis at the transmitter is also a key to the signal integrity at the receiver. Pre-emphasis increases the signal edge rate, which also increases the crosstalk on neighboring signals.

Because the impact of pre-emphasis is dependent on the transmission line characteristics, simulation is required to ensure the impact is minimal. Over emphasis of the signal can further degrade the signal quality instead of improving it.

The use of LVDS_PRE_EMPHASIS=TRUE and LVDS_PRE_EMPHASIS=FALSE results in two different I/O standards, that cannot be placed together into a single I/O bank. This can result in the following placement design rule violation found during report_drc:

```
ERROR: [DRC 23-20] Rule violation (DIFFSTDLIMIT-1) Too many true differential output standards in bank.
```

Architecture Support

UltraScale devices.

Applicable Objects

- Ports (get_ports)

Value

- **TRUE:** Enable pre-emphasis for differential inputs and bidirectional buffers implementing the LVDS I/O standard. When set to TRUE, the ENABLE_PRE_EMPHASIS property on the TX_BITSLICE must also be set to TRUE.
- **FALSE:** Do not enable pre-emphasis (default).

Syntax

Verilog and VHDL Syntax

Not applicable

XDC Syntax

The LVDS_PRE_EMPHASIS attribute uses the following syntax in the XDC file:

```
set_property LVDS_PRE_EMPHASIS <TRUE|FALSE> [get_ports port_name]
```

Where:

- `set_property LVDS_PRE_EMPHASIS` enables pre-emphasis at the transmitter.
- `port_name` is an output or bidirectional port connected to a differential output buffer.

See Also

[EQUALIZATION](#), page 207

[PRE_EMPHASIS](#), page 312

MARK_DEBUG

Use MARK_DEBUG to specify that a net should be preserved during synthesis for hardware debug. This will prevent optimization that could otherwise eliminate or change the name of the specified signal. The MARK_DEBUG property preserves the signal to provide an easy means of observing the values on this signal during hardware debug.

MARK_DEBUG prevents optimizations, much like the , DONT_TOUCH, , KEEP, or , KEEP_HIERARCHY properties. MARK_DEBUG can also affect optimization of hierarchical modules connected to signals that are marked for debug. While this can assist analysis and debugging, reduced optimization can result in a larger, slower design. For this reason, it is recommended to use MARK_DEBUG sparingly, particularly on timing critical areas of the design; and to only attach to synchronous points in the design to limit the increased area and power, and the impact on timing closure.



IMPORTANT: *In some cases MARK_DEBUG can have unintended consequences on the optimization of signals that are not marked for debug, but that are connected to hierarchical modules that also connect to signals marked for debug.*

Often, you identify nets for debugging through the pins of hierarchies or cells; however, the MARK_DEBUG property must be assigned to nets. Therefore, it is recommended that you assign MARK_DEBUG using both the `get_nets` and the `get_pins` commands:

```
set_property MARK_DEBUG true [get_nets -of [get_pins hier1/hier2/<flop_name>/Q]]
```

This ensures that the MARK_DEBUG property is assigned to the net connected to the specified pin, regardless of how the net is named, or renamed.

Architecture Support

All architectures.

Applicable Objects

- Nets (`get_nets`)
 - Any net accessible to the internal array.

Note: Some nets may have dedicated connectivity or other aspects that prohibit visibility for debug purposes.

Values

- **TRUE:** Preserve the signal for use during debug.
- **FALSE:** Do not preserve the signal (default).

Syntax

Verilog Syntax

To set this attribute, place the proper Verilog attribute syntax before the top-level output port declaration:

```
(* MARK_DEBUG = "{TRUE|FALSE}" *)
```

Verilog Syntax Example

```
// Marks an internal wire for debug in Vivado hardware manager  
(* MARK_DEBUG = "TRUE" *) wire debug_wire,
```

VHDL Syntax

Declare the VHDL attribute as follows:

```
attribute MARK_DEBUG : string;
```

Specify the VHDL attribute as follows:

```
attribute MARK_DEBUG of signal_name : signal is "{TRUE|FALSE}";
```

Where

- `signal_name` is an internal signal.

VHDL Syntax Example

```
signal debug_wire : std_logic;  
attribute MARK_DEBUG : string;  
-- Marks an internal wire for debug in Vivado hardware manager  
attribute MARK_DEBUG of debug_wire : signal is "TRUE";
```

XDC Syntax

```
set_property MARK_DEBUG value [get_nets <net_name>]
```

Where: `<net_name>` is a signal name.

XDC Syntax Example

```
# Marks an internal wire for debug  
set_property MARK_DEBUG TRUE [get_nets debug_wire]
```

Affected Steps

- synth_design
- opt_design
- place_design
- Vivado hardware manager

See Also

[DONT_TOUCH](#), page 197

[KEEP](#), page 258

[KEEP_HIERARCHY](#), page 263

MAX_FANOUT

MAX_FANOUT instructs Vivado synthesis on the fanout limits for registers and signals, after which the driver must be replicated. The value is specified as an integer.

MAX_FANOUT overrides the default value of the global synthesis option `-fanout_limit`. You can set the default limit for a design from the Synthesis page of the **Tools > Settings** command, or by using the `-fanout_limit` command line option of the [synth_design](#) command.



IMPORTANT: *During Vivado synthesis, the MAX_FANOUT attribute is enforced whereas the `-fanout_limit` constitutes only a guideline for the tool, not a strict command. When strict fanout control is required, use MAX_FANOUT. Also, unlike the `-fanout_limit` switch, MAX_FANOUT can impact control signals. The `-fanout_limit` switch does not impact control signals (such as set, reset, clock enable), use MAX_FANOUT to replicate these signals if needed.*

This attribute only works on registers and combinatorial signals. To meet the specified fanout limit, Vivado synthesis replicates the register or the driver that drives the combinatorial signal. This attribute can be set in the RTL or the XDC.

MAX_FANOUT also comes into play during placement optimization when the placer can replicate registers driving high-fanout nets, or registers driving nets with loads that are placed far apart, or nets with a MAX_FANOUT property value that has not been satisfied. Fanout optimization occurs early in the placement flow, reducing the timing criticality of paths before starting detailed placement.

When the MAX_FANOUT value is less than the actual fanout of the constrained net the net is always evaluated for replication, but the optimization can be skipped if timing does not improve. The post-replication fanout will not necessarily match the MAX_FANOUT constraint value.

Architecture

All devices.

Applicable Elements

- Registers and combinatorial signals

Values

- `<Integer>`: Specifies maximum limit of fanout, after which the driver is replicated.

Syntax

Verilog Syntax

On Signal:

```
(* max_fanout = 50 *) reg sig1;
```

VHDL Syntax

```
signal sig1 : std_logic;  
attribute max_fanout : integer;  
attribute max_fanout of sig1: signal is 50;
```

XDC Syntax

```
set_property MAX_FANOUT <number> [get_nets -hier <net_name>]
```

Affected Steps

- synth_design
- place_design

MUXF_REMAP

The `opt_design -muxf_remap` option lets you convert MUXF7, MUXF8, and MUXF9 primitives to LUT3 to reduce routing congestion.

This property works similar to the LUT_REMAP property. If it is set to true on a MUXF* cell it will automatically trigger the MUX remap optimization during `opt_design`, and map those cells to a LUT3.

Unlike the LUT_REMAP property though, the MUXF_REMAP property also lets you limit the scope of the `-muxf_remap` optimization by setting the property to FALSE on individual MUXF cells. If the property is set to FALSE on a MUXF cell, and the `opt_design -muxf_remap` command is called, it will prevent those MUXF cells from being mapped to a LUT3.

Refer to the *Vivado Design Suite User Guide: Implementation* (UG904) [Ref 20] for more information on optimization.

Architecture Support

- All architectures.

Applicable Objects

- MUXF Cells (`get_cells`)

Value

- **TRUE | 1**
 - If `opt_design -mux_remap` is called, the presence of the MUXF_REMAP property with a value of TRUE has no additional effect.
 - If `opt_design -mux_remap` is not called, the presence of the MUXF_REMAP property with a value of TRUE on specific cells will call MUX remapping for those specific cells only during `opt_design`.
- **FALSE | 0**
 - If `opt_design -mux_remap` is called, the presence of the MUXF_REMAP property with a value of FALSE will prevent the specified MUX from being remapped.
 - If `opt_design -mux_remap` is not called, the presence of the MUXF_REMAP property with a value of FALSE has no additional effect.

Syntax

Verilog and VHDL Syntax

Not applicable

XDC Syntax

```
set_property MUXF_REMAP <value> <objects>
```

XDC Syntax Example

The following assigns the MUXF_REMAP property as FALSE to the specified MUXF primitives to exclude these cells from remapping when the `opt_design -mux_remap` command is used:

```
set_property MUXF_REMAP 0 [get_cells -hier \  
-filter {name =~ cpu* && ref_name =~ MUXF*}]
```

Affected Steps

- Logic Optimization (`opt_design`)

See Also

[CARRY_REMAP](#), page 157

[LUT_REMAP](#), page 281

ODT

The On-Die Termination (ODT) property is used to define the value of the on-die termination for both digitally controlled impedance (DCI) and non-DCI versions of the I/O standards supported. The advantage of using ODT over external resistors is that signal integrity is improved by completely removing the stub at the receiver.



IMPORTANT: For 7 series FPGAs, use *IN_TERM* instead of ODT to specify uncalibrated termination.

ODT supports split or single termination on the inputs of the HSTL, SSTL, POD, and HSUL standards. The V_{CCO} of the I/O bank must be connected to the appropriate voltage level for the ODT attribute to perform as expected. Refer to the *UltraScale Architecture SelectIO Resources User Guide* (UG571) [Ref 8] for the V_{CCO} levels required for specific I/O standards.

For the I/O standards that support parallel termination, DCI creates a Thevenin equivalent, or split-termination resistance to the $V_{CCO} / 2$ voltage level. For POD and HSUL standards, DCI supports a single-termination to the V_{CCO} voltage level. The exact value of the termination resistors is determined by the ODT value. Possible ODT values for split-termination DCI are RTT_40, RTT_48, RTT_60, or RTT_NONE.

Note: DCI is only available in high-performance (HP) I/O banks. High-range (HR) I/O banks do not support DCI.

Both HR and HP I/O banks have an optional uncalibrated on-chip split-termination feature that creates a Thevenin equivalent circuit using two internal resistors of twice the target resistance value for HSTL and SSTL standards. They also provide an un-calibrated on-chip single-termination feature for POD and HSUL I/O standards. The termination is present constantly on inputs, and is present on bidirectional ports whenever the output buffer is 3-stated. The use of a DCI-based I/O standard determines whether the DCI or un-calibrated termination is invoked in a design. In both DCI and un-calibrated I/O standards, the values of the termination resistors are determined by the ODT attribute.

While the 3-state split-termination DCI is calibrated against external reference resistors on the VRN and VRP pins, the ODT property invokes an uncalibrated split-termination option using internal resistors that have no calibration to compensate for temperature, process, or voltage variations.

Architecture Support

UltraScale devices.

Applicable Objects

- Ports (`get_ports`)
 - Connected to input and bidirectional buffers.

Value

- RTT_40
- RTT_48
- RTT_60
- RTT_120
- RTT_240
- RTT_NONE

Note: Not all values are allowed for all applicable I/O standards and configurations.

Syntax

Verilog and VHDL Syntax

Not applicable

XDC Syntax

The ODT attribute uses the following syntax in the XDC file:

```
set_property ODT <VALUE> [get_ports port_name]
```

Where:

- `set_property ODT` enables the on die termination.
- `<Value>` is one of the valid ODT values for the specified IOSTANDARD.
- `port_name` is an input or bidirectional port connected to a differential buffer.

See Also

[IN_TERM](#), page 234

[IOSTANDARD](#), page 251

OFFSET_CNTRL

Receiver OFFSET Control, `OFFSET_CNTRL`, is available for some I/O standards on UltraScale devices to compensate for process variations. `OFFSET_CNTRL` can only be assigned to high-performance (HP) I/Os.

In HP I/O banks, for a subset of I/O standards, the UltraScale architecture provides the option of canceling the inherent offset of the input buffers that occurs due to process variations (up to ± 35 mV).

This feature is available for input and bidirectional buffer primitives.

Offset calibration requires building control logic into your interconnect logic design. Refer to the *UltraScale Architecture SelectIO Resources User Guide* (UG571) [Ref 8] for more information.

Architecture Support

UltraScale devices.

Applicable Objects

- Ports (`get_ports`)
 - Any top-level port

Value

The valid values for the `OFFSET_CNTRL` attribute are:

- **CNTRL_NONE**: Do not enable offset cancellation (default)..
- **FABRIC**: Invokes the offset cancellation feature in an I/O bank.



IMPORTANT: *There must be an offset control circuit on the fabric to handle the offset cancellation.*

Syntax

Verilog and VHDL Syntax

Not applicable

XDC Syntax

The OFFSET_CNTRL attribute uses the following syntax in the XDC file:

```
set_property OFFSET_CNTRL <value> [get_ports port_name]
```

Where:

- `set_property OFFSET_CNTRL` enables offset cancellation feature.
- `<value>` is one of the valid OFFSET_CNTRL values.
- `port_name` is an input or bidirectional port connected.

Affected Steps

- Placement
- Routing

PACKAGE_PIN

PACKAGE_PIN defines a specific assignment, or placement, of a top-level port in the logical design to a physical package pin on the device.



RECOMMENDED: *To assign I/O ports to physical pins on the device package, use the PACKAGE_PIN property rather than LOCS. Use the LOC property to assign logic cells to device resources on the target Xilinx FPGA.*

Architecture Support

All architectures.

Applicable Objects

- Ports (get_ports)
 - Any top-level port

Values

Package pin name

Syntax

Verilog Syntax

Place the Verilog attribute immediately before the port declaration:

```
(* PACKAGE_PIN = "pin_name" *)
```

Verilog Syntax Example

```
// Designates port CLK to be placed on pin B26  
(* PACKAGE_PIN = "B26" *) input CLK;
```

VHDL Syntax

Declare the VHDL attribute as follows:

```
attribute PACKAGE_PIN : string;
```

Specify the VHDL attribute as follows:

```
attribute PACKAGE_PIN of port_name : signal is "pin_name";
```

VHDL Syntax Example

```
-- Designates CLK to be placed on pin B26  
attribute PACKAGE_PIN of CLK : signal is "B26";
```

XDC Syntax

```
set_property PACKAGE_PIN pin_name [get_ports port_name]
```

XDC Syntax Example

```
# Designates CLK to be placed on pin B26  
set_property PACKAGE_PIN B26 [get_ports CLK]
```

Affected Steps

- Pin planning
- place_design

See Also

[LOC, page 268](#)

PATH_MODE

The PATH_MODE property determines how the Vivado Design Suite evaluates a path when trying to locate a file or reading a path-based constraint or property.

For every file in a project, and for most properties that refer to files and directories, the Vivado Design Suite attempts to store and maintain both a relative path and an absolute path to the file or directory. When a project is opened, these paths are used to locate the files and directories. By default the Vivado Design Suite applies a Relative First approach to resolving paths, searching the relative path first, then the absolute path. You can use the PATH_MODE property to change how the Vivado tool resolves file paths or properties for specific objects.



TIP: For some paths, in particular those on different drives on Windows, the Vivado tool cannot maintain a relative path. In these cases, only an absolute path is stored.

When the RelativeFirst or AbsoluteFirst settings are used, the Vivado tool will issue a warning when it has to use the alternate, or second path to find an object.

Architecture Support

All devices.

Applicable Objects

- Source files (`get_files`)

Values

- **RelativeFirst:** Use the relative path to the project to locate the file. If the file can not be found with this path, use the absolute path. This is the default value and is suitable for most uses.
- **AbsoluteFirst:** Use the absolute path to locate the file. If the file can not be found, use the relative path. AbsoluteFirst or AbsoluteOnly might be appropriate for files stored in a fixed repository, for example standard files used by everyone in a design group or company, or for a library of IP.
- **RelativeOnly:** Use only the relative path to locate the file. If the file can not be found, issue an appropriate message and treat the file as missing. The RelativeOnly or AbsoluteOnly settings might be appropriate when multiple files with the same name exist, and you need to insure that the correct file is located.
- **AbsoluteOnly:** Use only the absolute path to locate the file. If the file can not be found, issue an appropriate message and treat the file as missing.

Syntax

Verilog and VHDL Syntax

Not applicable

XDC Syntax

```
set_property PATH_MODE AbsoluteFirst [get_files *IP/*]
```

Affected Steps

- Project management and file location

PBLOCK

PBLOCK is a read-only property attached to cells that assigned to Pblocks in the Vivado Design Suite.

A Pblock is a collection of cells, and one or more rectangular areas or regions that specify the device resources contained by the Pblock. Pblocks are used during floorplanning placement to group related logic and assign it to a region of the target device. Refer to the *Vivado Design Suite User Guide: Design Analysis and Closure Techniques* (UG906) [Ref 22] for more information on the use of Pblocks in floorplanning your design.

Pblocks are created using the `create_pblock` Tcl command, and are populated with cells using the `add_cells_to_pblock` command. The following code defines a Pblock:

```
create_pblock Pblock_usbEngine
add_cells_to_pblock [get_pblocks Pblock_usbEngine] [get_cells -quiet [list
usbEngine1]]
resize_pblock [get_pblocks Pblock_usbEngine] -add {SLICE_X8Y105:SLICE_X23Y149}
resize_pblock [get_pblocks Pblock_usbEngine] -add {DSP48_X0Y42:DSP48_X1Y59}
resize_pblock [get_pblocks Pblock_usbEngine] -add {RAMB18_X0Y42:RAMB18_X1Y59}
resize_pblock [get_pblocks Pblock_usbEngine] -add {RAMB36_X0Y21:RAMB36_X1Y29}
```

The first line creates the Pblock, giving it a name.

The second line assigns logic cells to the Pblock. In this case, all of the cells in the specified hierarchical module are assigned to the Pblock. Cells that are assigned to a specific Pblock are assigned the PBLOCK property.

The subsequent commands, `resize_pblock`, define the size of the Pblock by specifying a range of device resources that are contained inside the Pblock. A pblock has a grid of four device resource types: SLICE/CLB, DSP48, RAMB18, RAMB36. Logic that does not match one of these device types can be placed anywhere in the device. To constrain just the Block RAMs in the level of hierarchy, disable (or simply do not define) the other Pblock grids.

Refer to the *Vivado Design Suite Tcl Command Reference Guide* (UG835) [Ref 13] for details on the specific Tcl commands mentioned above.

Architecture Support

All architectures.

Applicable Objects

- Cells (`get_cells`)

Values

- *<NAME>*: The property value is the name of the Pblock that the cell is assigned to. The Pblock name is defined when the Pblock is created with the `create_pblock` command.

Syntax

Verilog and VHDL Syntax

Not applicable

XDC Syntax

The Pblock can be defined in the XDC file, or directly in the design, with the Tcl command:

```
create_pblock <pblock_name>
```

XDC Example

The following code defines a Pblock:

```
create_pblock Pblock_usbEngine
add_cells_to_pblock [get_pblocks Pblock_usbEngine] [get_cells -quiet [list
usbEngine1]]
resize_pblock [get_pblocks Pblock_usbEngine] -add {SLICE_X8Y105:SLICE_X23Y149}
resize_pblock [get_pblocks Pblock_usbEngine] -add {DSP48_X0Y42:DSP48_X1Y59}
resize_pblock [get_pblocks Pblock_usbEngine] -add {RAMB18_X0Y42:RAMB18_X1Y59}
resize_pblock [get_pblocks Pblock_usbEngine] -add {RAMB36_X0Y21:RAMB36_X1Y29}
```

Affected Steps

- Design Floorplanning
- `place_design`

See Also

[BEL](#), page 149

[CONTAIN_ROUTING](#), page 181

[LOC](#), page 268

[EXCLUDE_PLACEMENT](#), page 211

POST_CRC

The Post CRC (POST_CRC) constraint enables or disables the Cyclic Redundancy Check (CRC) error detection feature for configuration logic, allowing for notification of any possible change to the configuration memory. This feature is only supported in 7 series FPGAs. For more information refer to the *7 Series FPGAs Configuration User Guide* (UG470) [Ref 1].



TIP: *Alternatively, Xilinx recommends use of the Xilinx Soft Error Mitigation (SEM) IP for all architectures. This IP automates the implementation of single event upset (SEU) detection and correction. For additional information, refer to the Soft Error Mitigation Controller LogiCORE IP Product Guide (PG036) [Ref 28].*

Enabling the POST_CRC property controls the generation of a pre-computed CRC value in the bitstream. As the configuration data frames are loaded, the device calculates a Cyclic Redundancy Check (CRC) value from the configuration data packets. After the configuration data frames are loaded, the configuration bitstream can issue a Check CRC instruction to the device, followed by the pre-computed CRC value. If the CRC value calculated by the device does not match the expected CRC value in the bitstream, the device pulls INIT_B Low and aborts configuration.

When CRC is disabled a constant value is inserted in the bitstream in place of the CRC, and the device does not calculate a CRC.

Architecture Support

7 series FPGAs.

Applicable Objects

- Design (`current_design`)
 - The current implemented design.

Values

- **DISABLE:** Disables the Post CRC checking feature (default).
- **ENABLE:** Enables the Post CRC checking feature.

Syntax

Verilog and VHDL Syntax

Not applicable

XDC Syntax

```
set_property POST_CRC ENABLE | DISABLE [current_design]
```

XDC Syntax Example

```
set_property POST_CRC Enable [current_design]
```

Affected Steps

- write_bitstream
- launch_runs

See Also

[POST_CRC_ACTION](#), page 304

[POST_CRC_FREQ](#), page 306

[POST_CRC_INIT_FLAG](#), page 308

[POST_CRC_SOURCE](#), page 310

POST_CRC_ACTION

The Post CRC Action property (POST_CRC_ACTION) applies to the configuration logic CRC error detection mode. This property determines the action that the device takes when a CRC mismatch is detected: correct the error, continue operation, or stop configuration. This feature is only supported in 7 series FPGAs. For more information refer to the *7 Series FPGAs Configuration User Guide* (UG470) [Ref 1].



TIP: Alternatively, Xilinx recommends use of the Xilinx Soft Error Mitigation (SEM) IP for all architectures. This IP automates the implementation of single event upset (SEU) detection and correction. For additional information, refer to the *Soft Error Mitigation Controller LogiCORE IP Product Guide* (PG036) [Ref 28].

During readback, the syndrome bits are calculated for every frame. If a single bit error is detected, the readback is stopped immediately. If correction is enabled using the POST_CRC_ACTION property, then the readback CRC logic performs correction on single bit errors. The frame in error is readback again, and using the syndrome information, the bit in error is fixed and written back to the frame. If the POST_CRC_ACTION is set to Correct_And_Continue, then the readback logic starts over from the first address. If the Correct_And_Halt option is set, the readback logic stops after correction.

This property is only applicable when [POST_CRC](#) is set to ENABLE.

Architecture Support

7 series FPGAs.

Applicable Objects

- Design (`current_design`)
 - The current implemented design.

Values

- **HALT:** If a CRC mismatch is detected, stop reading back the bitstream, stop computing the comparison CRC, and stop making the comparison against the pre-computed CRC.
- **CONTINUE:** If a CRC mismatch is detected by the CRC comparison, continue reading back the bitstream, computing the comparison CRC, and making the comparison against the pre-computed CRC.
- **CORRECT_AND_CONTINUE:** If a CRC mismatch is detected by the CRC comparison, it is corrected and continues reading back the bitstream, computing the comparison CRC, and making the comparison against the pre-computed CRC.

- **CORRECT_AND_HALT:** If a CRC mismatch is detected, it is corrected and stops reading back the bitstream, computing the comparison CRC, and making the comparison against the pre-computed CRC.

Syntax

Verilog and VHDL Syntax

Not applicable

XDC Syntax

```
set_property POST_CRC_ACTION <VALUE> [current_design]
```

Where:

- <VALUE> is one of the accepted values for the POST_CRC_ACTION property.

XDC Syntax Example

```
set_property POST_CRC_ACTION correct_and_continue [current_design]
```

Affected Steps

- write_bitstream
- launch_runs

See Also

[POST_CRC, page 302](#)

[POST_CRC_FREQ, page 306](#)

[POST_CRC_INIT_FLAG, page 308](#)

[POST_CRC_SOURCE, page 310](#)

POST_CRC_FREQ

The Post CRC Frequency property (POST_CRC_FREQ) controls the frequency with which the configuration CRC check is performed for the current design. This feature is only supported in 7 series FPGAs. For more information refer to the *7 Series FPGAs Configuration User Guide* (UG470) [Ref 1].



TIP: *Alternatively, Xilinx recommends use of the Xilinx Soft Error Mitigation (SEM) IP for all architectures. This IP automates the implementation of single event upset (SEU) detection and correction. For additional information, refer to the Soft Error Mitigation Controller LogiCORE IP Product Guide (PG036) [Ref 28].*

This property is only applicable when **POST_CRC** is set to ENABLE. Enabling the POST_CRC property controls the periodic comparison of a pre-computed CRC value in the bitstream with an internal CRC value computed by readback of the configuration memory cells.

The POST_CRC_FREQ defines the frequency in MHz of the readback function, with a default value of 1 MHz.

Architecture Support

7 series FPGAs.

Applicable Objects

- Design (`current_design`)
 - The current implemented design.

Values

- Specify the frequency in MHz as an integer with one of the following accepted values:
 - 1, 2, 3, 6, 13, 25, and 50
 - Default = 1 MHz

Syntax

Verilog and VHDL Syntax

Not applicable

XDC Syntax

```
set_property POST_CRC_FREQ <VALUE> [current_design]
```

Where:

- <VALUE> is one of the accepted values for the POST_CRC_FREQ property.

XDC Syntax Example

```
set_property POST_CRC_FREQ 50 [current_design]
```

Affected Steps

- write_bitstream
- launch_runs

See Also

[POST_CRC](#), page 302

[POST_CRC_ACTION](#), page 304

[POST_CRC_INIT_FLAG](#), page 308

[POST_CRC_SOURCE](#), page 310

POST_CRC_INIT_FLAG

The Post CRC INIT Flag property (POST_CRC_INIT_FLAG) determines whether the INIT_B pin is enabled as an output for the SEU (Single Event Upset) error signal. This feature is only supported in 7 series FPGAs. For more information refer to the *7 Series FPGAs Configuration User Guide* (UG470) [Ref 1].



TIP: *Alternatively, Xilinx recommends use of the Xilinx Soft Error Mitigation (SEM) IP for all architectures. This IP automates the implementation of single event upset (SEU) detection and correction. For additional information, refer to the Soft Error Mitigation Controller LogiCORE IP Product Guide (PG036) [Ref 28].*

The error condition is always available from the FRAME_ECC site. However, when the POST_CRC_INIT_FLAG is ENABLED, which is the default, the INIT_B pin also flags the CRC error condition when it occurs.

This property is only applicable when [POST_CRC](#) is set to ENABLE.

Architecture Support

7 series FPGAs.

Applicable Objects

- Design (current_design)
 - The current implemented design.

Values

- DISABLE: Disables the use of the INIT_B pin, with the FRAME_ECC site as the sole source of the CRC error signal.
- ENABLE: Leaves the INIT_B pin enabled as a source of the CRC error signal (default).

Syntax

Verilog and VHDL Syntax

Not applicable

XDC Syntax

```
set_property POST_CRC_INIT_FLAG ENABLE | DISABLE [current_design]
```

XDC Syntax Example

```
set_property POST_CRC_INIT_FLAG Enable [current_design]
```

Affected Steps

- write_bitstream
- launch_runs

See Also

[POST_CRC](#), page 302

[POST_CRC_ACTION](#), page 304

[POST_CRC_FREQ](#), page 306

[POST_CRC_SOURCE](#), page 310

POST_CRC_SOURCE

The Post CRC Source (POST_CRC_SOURCE) constraint specifies the source of the CRC value when the configuration logic CRC error detection feature is used for notification of any possible change to the configuration memory. This feature is only supported in 7 series FPGAs. For more information refer to the *7 Series FPGAs Configuration User Guide* (UG470) [Ref 1].



TIP: *Alternatively, Xilinx recommends use of the Xilinx Soft Error Mitigation (SEM) IP for all architectures. This IP automates the implementation of single event upset (SEU) detection and correction. For additional information, refer to the Soft Error Mitigation Controller LogiCORE IP Product Guide (PG036) [Ref 28].*

This property is only applicable when **POST_CRC** is set to ENABLE. Enabling the POST_CRC property controls the generation of a pre-computed CRC value in the bitstream. As the configuration data frames are loaded, the device calculates a Cyclic Redundancy Check (CRC) value from the configuration data packets.

The POST_CRC_SOURCE property defines the expected CRC value as either coming from a pre-computed value, or as being taken from the configuration data in the first readback pass.

Architecture Support

7 series FPGAs.

Applicable Objects

- Design (current_design)
 - The current implemented design.

Values

- **PRE_COMPUTED:** Determine an expected CRC value from the bitstream (default).
- **FIRST_READBACK:** Extract the actual CRC value from the first readback pass, to use for comparison with future readback iterations.

Syntax

Verilog and VHDL Syntax

Not applicable

XDC Syntax

```
set_property POST_CRC_SOURCE FIRST_READBACK | PRE_COMPUTED [current_design]
```

XDC Syntax Example

```
set_property POST_CRC_SOURCE PRE_COMPUTED [current_design]
```

Affected Steps

- write_bitstream
- launch_runs

See Also

[POST_CRC](#), page 302

[POST_CRC_ACTION](#), page 304

[POST_CRC_FREQ](#), page 306

[POST_CRC_INIT_FLAG](#), page 308

PRE_EMPHASIS

The PRE_EMPHASIS property is used to improve signal integrity of high-frequency signals that suffer high-frequency losses through the transmission line. The transmitter pre-emphasis (PRE_EMPHASIS) feature allows pre-emphasis on the signal drivers for certain I/O standards.



TIP: Pre-emphasis at the transmitter can be combined with [EQUALIZATION](#) at the receiver to improve the overall signal integrity.

Ideal signals perform a logic transition within the symbol interval of the frequency. However, lossy transmission lines can expand beyond the symbol interval. Pre-Emphasis provides a voltage gain at the transitions to account for transmission-line losses. In the frequency domain, pre-emphasis boosts the high-frequency energy on every transition in the data stream.

The pre-emphasis selection is also a key to the signal integrity at the receiver. Pre-emphasis increases the signal edge rate, which also increases the crosstalk on neighboring signals.

Because the impact of pre-emphasis on crosstalk and signal discontinuity is dependant on the transmission line characteristics, simulation is required to ensure the impact is minimal. Over emphasis of the signal can further degrade the signal quality instead of improving it.

Architecture Support

UltraScale architecture.

Applicable Objects

- Ports (`get_ports`)

Value

The allowed values for the PRE_EMPHASIS attribute are:

- **RDRV_240:** Enable pre-emphasis. When enabled, the ENABLE_PRE_EMPHASIS property on the TX_BITSLICE must also be set to TRUE.
- **RDRV_NONE:** Do not enable transmitter pre-emphasis (default).

Syntax

Verilog and VHDL Syntax

Not applicable

XDC Syntax

The PRE_EMPHASIS attribute uses the following syntax in the XDC file:

```
set_property PRE_EMPHASIS value [get_ports port_name]
```

Where:

- `set_property PRE_EMPHASIS` enables pre-emphasis at the transmitter.
- `port_name` is an output or bidirectional port connected to a differential output buffer.

See Also

[EQUALIZATION](#), page 207

[LVDS_PRE_EMPHASIS](#), page 283

PROCESSING_ORDER

The PROCESSING_ORDER property determines if an XDC file will be processed early by the Vivado Design Suite during constraint processing, or processed normally, or processed late. The PROCESSING_ORDER can be: EARLY, NORMAL, or LATE.

By default, the Vivado Design Suite reads XDC files for IP cores before the user XDC files defined in the constraint fileset for the top-level design. Processing constraints in this way allows an IP to define constraints required by the core, while letting you override those IP constraints with user constraints processed later. Refer to this [link](#) in the *Vivado Design Suite User Guide: Using Constraints* (UG903) [Ref 19] for more information.

The default processing order for constraint files is:

1. User Constraints marked as EARLY
2. IP Constraints marked as EARLY (default)
3. User Constraints marked as NORMAL
4. IP Constraints marked as LATE (contain clock dependencies)
5. User Constraints marked as LATE

User constraint files marked with a common PROCESSING_ORDER will be processed in the order they are defined in a constraint set, as displayed in the Vivado IDE. The order of the files can be modified by changing the compile order of the files in the Vivado IDE, or by using the `reorder_files` command.

Architecture Support

All architectures.

Applicable Objects

- Constraint Files, XDC or Tcl, (`get_files`)

Values

- **EARLY**: Process these files before other constraint files.
- **NORMAL**: Process these files after the EARLY files and before the LATE files (default).
- **LATE**: Process these files after other constraint files.

Syntax

Verilog and VHDL Syntax

Not applicable

XDC Syntax

```
set_property PROCESSING_ORDER {EARLY | NORMAL | LATE} [get_files <filename>]
```

Where

- *<filename>* is the filename of an XDC or Tcl constraints file.

XDC Syntax Example

```
set_property PROCESSING_ORDER EARLY [get_files char_fifo_ooc.xdc]
```

Affected Steps

- Synthesis
- Implementation

PROHIBIT

PROHIBIT specifies that a BEL or SITE cannot be used for placement.



TIP: The use of PROHIBIT on RAMB18 sites will not prohibit the placement of a RAMB36. Likewise the use of PROHIBIT on RAMB36 sites will not prohibit the placement of the RAMB18.

Architecture Support

All architectures.

Applicable Objects

- SITEs (`get_sites`)
- BELs (`get_bels`)

Values

- **TRUE** (or 1): Prohibit the specified BEL or SITE from use during placement.

Syntax

Verilog and VHDL Syntax

Not applicable

XDC Syntax

```
set_property PROHIBIT 1 [get_sites site]
```

XDC Syntax Example

```
# Prohibit the use of package pin Y32
set_property prohibit 1 [get_sites Y32]
```

Affected Steps

- I/O planning
- place_design

PULLDOWN



IMPORTANT: *The PULLDOWN property has been deprecated and should be replaced by [PULLTYPE](#).*

PULLDOWN applies a weak logic low level on a tri-stateable output or bidirectional port to prevent it from floating. The PULLDOWN property guarantees a logic Low level to allow tri-stated nets to avoid floating when not being driven.

Input buffers (e.g., IBUF), 3-state output buffers (e.g., OBUFT), and bidirectional buffers (e.g., IOBUF) can have a weak pull-up resistor, a weak pull-down resistor, or a weak “keeper” circuit. This feature can be invoked by adding the PULLTYPE property with one of the following properties to the port or net object connected to the buffer:

- PULLUP
- PULLDOWN
- KEEPER

Note: When this attribute is applied, the PULLDOWN functionality will not be shown during RTL simulation which may create a functional difference between RTL simulation and the implemented design. This functionality can be verified using a gate-level simulation netlist or else the PULLDOWN UNISIM may be instantiated in the design in place of using this property in order to reflect this behavior in the RTL simulation.

For more information see the *Vivado Design Suite 7 Series FPGA and Zynq-7000 SoC Libraries Guide* (UG953) [[Ref 25](#)] or the *UltraScale Architecture Libraries Guide* (UG974) [[Ref 26](#)].

Architecture Support

All architectures.

Applicable Objects

- Ports (`get_ports`): Apply to any top-level port.

Values

- **TRUE|YES:** Use a pulldown circuit to avoid signal floating when not being driven.
- **FALSE|NO:** Do not use a pulldown circuit (default)..

Syntax

Verilog Syntax

Place the Verilog attribute immediately before the module or instantiation. Specify as follows:

```
(* PULLDOWN = " {YES|NO|TRUE|FALSE}" *)
```

VHDL Syntax

Declare the VHDL attribute as follows:

```
attribute pulldown: string;
```

Specify the VHDL attribute as follows:

```
attribute pulldown of signal_name : signal is "{YES|NO|TRUE|FALSE}";
```

XDC Syntax

```
set_property PULLDOWN {TRUE|FALSE} [get_ports port_name]
```

Where

- `port_name` is the name of an input, output, or inout port.

XDC Syntax Example

```
# Use a pulldown circuit  
set_property PULLDOWN TRUE [get_ports wbWriteOut]
```

Affected Steps

- Logical to Physical Mapping

See Also

[KEEPER](#), page 266

[PULLUP](#), page 322

PULLTYPE



IMPORTANT: The *PULLTYPE* property replaces *KEEPER*, *PULLDOWN*, and *PULLUP* properties, which have been deprecated.

Input buffers (e.g., IBUF), 3-state output buffers (e.g., OBUFT), and bidirectional buffers (e.g., IOBUF) can have a weak pull-up resistor, a weak pull-down resistor, or a weak “keeper” circuit. This feature can be invoked by adding the *PULLTYPE* property with one of the following properties to the port or net object connected to the buffer:

- PULLUP
- PULLDOWN
- KEEPER

Note: When this property is applied, the *KEEPER*, *PULLDOWN*, or *PULLUP* functionality will not be shown during RTL simulation which may create a functional difference between the RTL simulation results and the implemented design. This functionality can be verified by using the post-synthesis gate-level netlist which includes the object; or by instantiating the appropriate UNISIM object into the design in place of using the *PULLTYPE* property in order to reflect this behavior in the RTL simulation.

For differential inputs or outputs, you can set the following parameter to define the preferred termination strategy:

```
set_param iconstr.diffPairPulltype { auto | same | opposite }
```

Where:

- **AUTO:** This is the default for all architectures.
 - For 7 series devices, the last specified *PULLTYPE* property on the differential pair will win.
 - For UltraScale and UltraScale+ architecture, *AUTO* has the same effect as *OPPOSITE*.
- **SAME:** both the positive and negative side are *PULLUP* or *PULLDOWN*, as defined by the *PULLTYPE* property.
- **OPPOSITE:** The P-side is assigned a *PULLUP*, and the N-side is assigned a *PULLDOWN*, regardless of the *PULLTYPE* setting.

For more information see the *Vivado Design Suite 7 Series FPGA and Zynq-7000 SoC Libraries Guide* (UG953) [Ref 25] or the *UltraScale Architecture Libraries Guide* (UG974) [Ref 26].

Architecture Support

All architectures.

Applicable Objects

- Ports (`get_ports`): Apply to any top-level port.

Values

- **KEEPER**: Use a keeper circuit to preserve the value on the net connected to the specified port.
- **PULLDOWN**: Use a pulldown circuit to avoid signal floating when not being driven.
- **PULLUP**: Use a pullup circuit to avoid signal floating when not being driven.
- **{}**: (NULL) Do not use a keeper, pulldown, or pullup circuit (default).

Syntax

Verilog Syntax

Place the Verilog attribute immediately before the module or instantiation. Specify as follows:

```
(* PULLTYPE = " {KEEPER|PULLDOWN|PULLUP| }" *)
```

VHDL Syntax

Declare the VHDL attribute as follows:

```
attribute PULLTYPE: string;
```

Specify the VHDL attribute as follows:

```
attribute PULLTYPE of signal_name : signal is "{KEEPER|PULLDOWN|PULLUP| }";
```

XDC Syntax

```
set_property PULLTYPE {KEEPER|PULLDOWN|PULLUP| } [get_ports port_name]
```

Where

- `port_name` is the name of an input, output, or inout port.

XDC Syntax Example

```
set_property PULLTYPE PULLUP [get_ports wbWriteOut]
```

-or-

```
set_property PULLTYPE {} [get_ports wbWriteOut]
```

Affected Steps

- Logical to Physical Mapping

See Also

[KEEPER](#), page 266

[PULLDOWN](#), page 317

[PULLUP](#), page 322

PULLUP



IMPORTANT: The *PULLUP* property has been deprecated and should be replaced by the *PULLTYPE* property.

PULLUP applies a weak logic High on a tri-stateable output or bidirectional port to prevent it from floating. The PULLUP property guarantees a logic High level to allow tri-stated nets to avoid floating when not being driven.

Input buffers (e.g., IBUF), 3-state output buffers (e.g., OBUFT), and bidirectional buffers (e.g., IOBUF) can have a weak pull-up resistor, a weak pull-down resistor, or a weak “keeper” circuit. This feature can be invoked by adding the PULLTYPE property with one of the following values to the port object connected to the buffer:

- PULLUP
- PULLDOWN
- KEEPER

Note: When this property is applied, the PULLUP functionality will not be shown during RTL simulation which may create a functional difference between RTL simulation and the implemented design. This functionality can be verified using a gate-level simulation netlist or else the PULLUP UNISIM may be instantiated in the design in place of using this property in order to reflect this behavior in the RTL simulation.

For more information see the *Vivado Design Suite 7 Series FPGA and Zynq-7000 SoC Libraries Guide* (UG953) [Ref 25] or the *UltraScale Architecture Libraries Guide* (UG974) [Ref 26].

Architecture Support

All architectures.

Applicable Objects

- Ports (`get_ports`): Apply to any top-level port.

Values

- **TRUE|YES:** Use a pullup circuit to avoid signal floating when not being driven.
- **FALSE|NO:** Do not use a pullup circuit (default).

Syntax

Verilog Syntax

Place the Verilog attribute immediately before the module or instantiation. Specify as follows:

```
(* PULLUP = " {YES|NO|TRUE|FALSE}" *)
```

VHDL Syntax

Declare the VHDL attribute as follows:

```
attribute pullup: string;
```

Specify the VHDL attribute as follows:

```
attribute pullup of signal_name : signal is "{YES|NO|TRUE|FALSE}";
```

XDC Syntax

```
set_property PULLUP {TRUE|FALSE} [get_ports port_name]
```

Where

- `port_name` is the name of an input, output, or inout port.

XDC Syntax Example

```
set_property PULLUP TRUE [get_ports wbWriteOut]
```

Affected Steps

- Logical to Physical Mapping

See Also

[KEEPER](#), page 266

[PULLDOWN](#), page 317

[PULLTYPE](#), page 319

RAM_DECOMP

The RAM_DECOMP property instructs the tool to infer RTL RAMs that are too large to fit in a single block RAM primitive to use a power efficient configuration, rather than a timing efficient solution.



TIP: This property only applies to Block RAMs, so it has no effect when RAM_STYLE indicates a distributed RAM configuration.

For example, a RAM specified as 2K x 36 would often be configured as two 2K x 18 block RAMs arranged side by side. This configuration yields the best timing results. However, by setting the RAM_DECOMP property, the RAM would instead be configured as 2 1K x 36 block RAMs. This configuration is more power-efficient because during a read or write, only the RAM with the address being used is active. This configuration is less timing efficient though, because Vivado synthesis must then use address decoding.

This attribute can be set in either RTL or XDC.

Architecture Support

All architectures.

Applicable Objects

- Cells (get_cells): Apply to RAM cells.

Values

- **power:** Configure RAM in a power efficient way, rather than timing efficient.



IMPORTANT: To restore the default synthesis behavior, you must remove the RAM_DECOMP property as there is no default setting.

Syntax

Verilog Syntax

```
(* ram_decomp = "power" *) reg [data_size-1:0] myram [2**addr_size-1:0];
```

VHDL Syntax

Declare the VHDL attribute as follows:

```
attribute ram_decomp : string;  
attribute ram_decomp of myram : signal is "power";
```

XDC Syntax

```
set_property ram_decomp power [get_cells myram]
```

Affected Steps

- Synthesis

See Also

[RAM_STYLE](#), page 326

RAM_STYLE

RAM_STYLE instructs the Vivado synthesis tool on how to infer memory in the design. For more information about RAM coding styles, see this [link](#) in the *Vivado Design Suite User Guide: Synthesis* (UG901) [Ref 18].

By default, the tool selects the type of RAM to infer based upon heuristics that give the best results for most designs. Place this attribute on the array that is declared for the RAM, or a level of hierarchy, to direct synthesis to infer a specific style of RAM. If set on a level of hierarchy, this affects all RAM in that level of hierarchy. Nested levels of hierarchy are not affected.

This property can be set in the RTL or the XDC.

Architecture Support

All architectures.

Applicable Objects

- Cells (`get_cells`): Apply to RAM cells.

Values

- **block**: Instructs the tool to infer Block RAM type components.
- **distributed**: Instructs the tool to infer distributed LUT RAMs.
- **registers**: Instructs the tool to infer registers instead of RAMs.
- **ultra**: Instructs the tool to use the UltraScale+ URAM primitives.



IMPORTANT: *To restore the default synthesis behavior, you must remove the RAM_STYLE property as there is no default setting.*

Syntax

Verilog Syntax

```
(* ram_style = "distributed" *) reg [data_size-1:0] myram [2**addr_size-1:0];
```

VHDL Syntax

```
attribute ram_style : string;  
attribute ram_style of myram : signal is "distributed";
```

XDC Syntax

```
set_property ram_style distributed [get_cells myram]
```

Affected Steps

- Synthesis

See Also

[RAM_DECOMP](#), page 324

REF_NAME

REF_NAME is a read-only property on cells of the design indicating a logical cell name that uniquely identifies the cell.

This property is defined automatically by the Vivado Design Suite, and can not be modified by the user in either HDL or XDC. It is intended for reference only.

The property does not influence any steps but is very useful in defining filters and other Vivado Tcl command queries to identify specific cells or other objects.

For example, to select the clock pins on RAM cells, you can filter the pin objects based on the REF_NAME property of the cells:

```
get_pins -hier */*W*CLK -filter {REF_NAME =~ *RAM* && IS_PRIMITIVE}
```



TIP: When an RTL module is instantiated multiple times in the design, synthesis sequentially numbers the original REF_NAME property to provide a unique identifier for each cell. In this case, the ORIG_REF_NAME property is used to store the original RTL module name (REF_NAME). As a result, you can filter both on REF_NAME and ORIG_REF_NAME to identify all instances of the cell:

```
get_cells -hierarchical \  
-filter {ORIG_REF_NAME == FifoBuffer || REF_NAME == FifoBuffer}
```

Architecture Support

All architectures.

Applicable Objects

- Cells (get_cells)

Values

Not applicable

Syntax

Not applicable

Affected Steps

None

REF_PIN_NAME

REF_PIN_NAME is a read-only property on pins in the design indicating a logical name that uniquely identifies the pin.

This property is automatically defined from the NAME or HIERARCHICAL NAME of the pin, and can not be modified by the user in either HDL or XDC. It is intended for reference only.

The property does not influence any steps but is very useful in defining filters and other Vivado Tcl command queries to identify specific cells or other objects.

Architecture Support

All architectures.

Applicable Objects

- Pins (get_pins)

Values

Not applicable

Syntax

Not applicable

Affected Steps

None

RLOC

Relative Location (RLOC) constraints define the relative placement of logic elements assigned to a set, such as an H_SET, HU_SET, or U_SET.

When RLOC is present in the RTL source files, the H_SET, HU_SET, or U_SET properties get translated into a read-only RPM property on cells in the synthesized netlist. The RLOC property is preserved, but becomes a read-only property after synthesis. For more information on using these properties, and defining RPMs, refer to the *Vivado Design Suite User Guide: Using Constraints* (UG903) [Ref 19].



TIP: When building hierarchical RPMs, use `synth_design -flatten_hierarchy none` to ensure that the RLOC properties are retained on their intended levels of hierarchy.

You can define the placement of any element within the set relative to other elements in the set, regardless of the eventual placement of the entire group onto the target device. For example, if RLOC constraints are applied to a group of eight flip-flops organized in a column, the mapper maintains the column and moves the entire group of flip-flops as a single unit. In contrast, the LOC constraint specifies the absolute location of a design element on the target device, without reference to other design elements.

Architecture Support

All architectures.

Applicable Objects

- Instances or Modules in the RTL source files.

Values

The Relative Location constraint is specified using a SLICE-based XY coordinate system.

$$\text{RLOC}=\text{XmYn}$$

Where:

- m is an integer representing the X coordinate value.
- n is an integer representing the Y coordinate value.



TIP: Because the X and Y numbers in Relative Location (RLOC) constraints define only the order and relationship between design elements, and not their absolute locations on the target device, their numbering can include negative integers.

Syntax

Verilog Syntax

The RLOC property is a Verilog attribute defining the relative placement of design elements within a set specified by H_SET, HU_SET, or U_SET in the RTL source files. Place the Verilog attribute immediately before the instantiation of a logic element.

```
(* RLOC = "XmYn", HU_SET = "h0" *) FD sr0 (.C(clk), .D(sr_1n), .Q(sr_0));
```

Verilog Example

The following Verilog module defines RLOC property for the shift register Flops in the ffs hierarchical module.

```
module inv (input a, output z);

    LUT1 #(.INIT(2'h1)) lut1 (.IO(a), .O(z));

endmodule // inv

module ffs
(
    input  clk,
    input  d,
    output q
);

    wire  sr_0, sr_0n;
    wire  sr_1, sr_1n;
    wire  sr_2, sr_2n;
    wire  sr_3, sr_3n;
    wire  sr_4, sr_4n;
    wire  sr_5, sr_5n;
    wire  sr_6, sr_6n;
    wire  sr_7, sr_7n;

    wire  inr, inrn, outr;

    inv i0 (sr_0, sr_0n);
    inv i1 (sr_1, sr_1n);
    inv i2 (sr_2, sr_2n);
    inv i3 (sr_3, sr_3n);
    inv i4 (sr_4, sr_4n);
    inv i5 (sr_5, sr_5n);
    inv i6 (sr_6, sr_6n);
    inv i7 (sr_7, sr_7n);
    inv i8 (inr, inrn);

    (* RLOC = "X0Y0" *) FD sr0 (.C(clk), .D(sr_1n), .Q(sr_0));
    (* RLOC = "X0Y1" *) FD sr1 (.C(clk), .D(sr_2n), .Q(sr_1));
    (* RLOC = "X0Y2" *) FD sr2 (.C(clk), .D(sr_3n), .Q(sr_2));
    (* RLOC = "X0Y3" *) FD sr3 (.C(clk), .D(sr_4n), .Q(sr_3));
    (* RLOC = "X0Y4" *) FD sr4 (.C(clk), .D(sr_5n), .Q(sr_4));
```

```

(* RLOC = "X0Y5" *) FD sr5 (.C(clk), .D(sr_6n), .Q(sr_5));
(* RLOC = "X0Y6" *) FD sr6 (.C(clk), .D(sr_7n), .Q(sr_6));
(* RLOC = "X0Y7" *) FD sr7 (.C(clk), .D(inrn), .Q(sr_7));
(* LOC = "SLICE_X0Y0" *) FD inq (.C(clk), .D(d), .Q(inr));
FD outq (.C(clk), .D(sr_0n), .Q(outr));

assign q = outr;

endmodule // ffs
    
```



TIP: In the preceding example, the presence of the RLOC property implies the use of the H_SET property on the FD instances in the ffs hierarchical module.

When using the modules defined in the preceding example, you will need to specify the KEEP_HIERARCHY property to instances of the ffs module to preserve the hierarchy and define the RPM in the synthesized design:

```

module top
(
    input  clk,
    input  d,
    output q
);

wire  c1, c2;

(* RLOC_ORIGIN = "X1Y1", KEEP_HIERARCHY = "YES" *) ffs u0 (clk, d, c1);
(* RLOC_ORIGIN = "X3Y3", KEEP_HIERARCHY = "YES" *) ffs u1 (clk, c1, c2);
(* RLOC_ORIGIN = "X5Y5", KEEP_HIERARCHY = "YES" *) ffs u2 (clk, c2, q);

endmodule // top
    
```

VHDL Syntax

Declare the VHDL constraint as follows:

```
attribute RLOC: string;
```

Specify the VHDL constraint as follows:

```
attribute RLOC of {component_name | entity_name | label_name} :
{component|entity|label} is "XmYn";
```

Where:

- {component_name | entity_name | label_name} is a choice of one design element.
- {component | entity | label} is the instance ID of the design element.
- XmYn defines the RLOC value for the specified design element.

XDC Syntax

The RLOC property can not be defined using XDC constraints. The RLOC property defines the relative locations of objects in a relatively placed macro (RPM), and results in read-only RPM and RLOC properties in the netlist of synthesized designs.



TIP: You can use the `create_macro` and `update_macro` commands to define macro objects in the Vivado Design Suite, that act like RPMs within the design. Refer to the Vivado Design Suite Tcl Command Reference Guide (UG835) [Ref 13] for more information on these commands.

Affected Steps

- Logical to Physical Mapping
- `place_design`
- `synth_design`

See Also

[H_SET and HU_SET, page 221](#)

[RLOC, page 330](#)

[RLOCS, page 334](#)

[RLOC_ORIGIN, page 336](#)

[RPM, page 341](#)

[RPM_GRID, page 342](#)

[U_SET, page 352](#)

RLOCS

RLOCS is a read-only property that is assigned to an XDC macro object that is created by the `create_macro` Tcl command in the Vivado Design Suite. The RLOCS property is assigned to the macro when it is updated with the `update_macro` command. Refer to the *Vivado Design Suite Tcl Command Reference Guide* (UG835) [Ref 13] for more information on these commands.

Like relatively placed macros (RPMs), XDC macros enable relative placement of groups of cells. Macros are similar to RPMs in many ways, yet also have significant differences:

- RPMs are defined in the RTL source files by a combination of the RLOC property and the H_SET, HU_SET, or U_SET property.
- RPMs cannot be edited in the post-synthesis design.
- Macros are created from leaf cells that are grouped together with relative placement, after synthesis, and can be edited.
- RPMs cannot be automatically converted to macros.
- RPMs are not design objects, and the XDC macro commands cannot be used on RPMs.

The RLOCS property reflects the relative placement values specified by the `update_macro` command, as represented by the `rlocs` argument:

```
"cell10 rloc0 cell11 rloc1 ... cellN rlocN"
```

You can use `update_macro` command to change the RLOCS property assigned to an XDC macro object.

The RLOCS property is converted to an RLOC property on each of the individual cells that are part of the XDC macro. The RLOC property then functions in the same way it does for an RPM, by defining the relative placement of cells in the macro.

Architecture Support

All architectures.

Applicable Objects

- Cells (`get_cells`)

Values

- Cell11 RLOC1 Cell12 RLOC2 Cell13 RLOC3...: The name of a cell in the macro paired with the relative location of the cell in the macro, defined for each cell in the macro.

Syntax

Verilog and VHDL Syntax

Not applicable

XDC Syntax

The RLOCS property is indirectly defined when an XDC macro is created and populated with cells and relative locations:

XDC Example

```
create_macro macro1
update_macro macro1 {u1/sr3 X0Y0 u1/sr4 X1Y0 u1/sr5 X0Y1}

report_property -all [get_macros macro1]
Property      Type      Read-only  Visible  Value
ABSOLUTE_GRID bool      true       true     0
CLASS         string   true       true     macro
NAME          string   true       true     macro1
RLOCS         string* true       true     u1/sr3 X0Y0 u1/sr4 X1Y0 u1/sr5
```

Affected Steps

- Logical to Physical Mapping
- synth_design
- place_design

See Also

[H_SET and HU_SET, page 221](#)

[RLOC, page 330](#)

[RLOC_ORIGIN, page 336](#)

[RPM, page 341](#)

[RPM_GRID, page 342](#)

[U_SET, page 352](#)

RLOC_ORIGIN

The RLOC_ORIGIN property provides an absolute location, or LOC, for the relatively placed macro (RPM) in the RTL design. For more information on defining RPMs, and using the RLOC_ORIGIN property, refer to the *Vivado Design Suite User Guide: Using Constraints* (UG903) [Ref 19].

RPMs are defined by assigning design elements to a set using the H_SET, HU_SET, or U_SET properties in the RTL design. The design elements are then assigned a relative placement to one another using the RLOC property. You can define the relative placement of any element within the set relative to other elements in the set, regardless of the eventual placement of the entire group onto the target device.

Having defined the elements of an RPM, and their relative placement, the RLOC_ORIGIN property lets you define the absolute placement of the RPM onto the target device. The RLOC_ORIGIN property is converted into LOC constraint during synthesis.

In the Vivado Design Suite, the RLOC_ORIGIN property defines the lower-left corner of the RPM. This is most often the design element whose RLOC property is X0Y0. Each remaining cell in the RPM set is placed on the target device using its relative location (RLOC) as an offset from the group origin (RLOC_ORIGIN).

Architecture Support

All architectures.

Applicable Objects

- Instances within the RTL source file.

Values

The Relative Location constraint is specified using a SLICE-based XY coordinate system.

```
RLOC_ORIGIN=XmYn
```

Where:

- m is an integer representing the absolute X coordinate on the target device of the lower-left corner of the RPM.
- n is an integer representing the absolute Y coordinate on the target device of the lower-left corner of the RPM.

Syntax

Verilog Syntax

The RLOC_ORIGIN property is a Verilog attribute defining the absolute placement of an RPM on the target device. Place the Verilog attribute immediately before the instantiation of a logic element.

```
(* RLOC_ORIGIN = "XmYn", HU_SET = "h0" *) FD sr0 (.C(clk), .D(sr_1n), .Q(sr_0));
```

Verilog Example

The following top-level Verilog module defines the RLOC_ORIGIN property for the ffs modules in the design.

```
module top
(
  input  clk,
  input  d,
  output q
);

  wire  c1, c2;

  (* RLOC_ORIGIN = "X1Y1", KEEP_HIERARCHY = "YES" *) ffs u0 (clk, d, c1);
  (* RLOC_ORIGIN = "X3Y3", KEEP_HIERARCHY = "YES" *) ffs u1 (clk, c1, c2);
  (* RLOC_ORIGIN = "X5Y5", KEEP_HIERARCHY = "YES" *) ffs u2 (clk, c2, q);

endmodule // top
```

The following example is very similar to the first, except that the RLOC_ORIGIN is only assigned to the first ffs module, u0, and the rest are defined with RLOC properties for relative placement:

```
module top
(
  input  clk,
  input  d,
  output q
);

  wire  c1, c2;

  // what would happen if the origin places the RPM outside
  // device?

  (* RLOC_ORIGIN = "X74Y15", RLOC = "X0Y0" *) ffs u0 (clk, d, c1);
  (* RLOC = "X1Y1" *) ffs u1 (clk, c1, c2);
  (* RLOC = "X2Y2" *) ffs u2 (clk, c2, q);

endmodule // top
```

VHDL Syntax

Declare the VHDL constraint as follows:

```
attribute RLOC_ORIGIN: string;
```

Specify the VHDL constraint as follows:

```
attribute RLOC_ORIGIN of {component_name | entity_name | label_name} :  
{component|entity|label} is "XmYn";
```

Where:

- {component_name | entity_name | label_name} is a choice of one design element.
- {component | entity | label} is the instance ID of the design element.
- XmYn defines the RLOC_ORIGIN value for the specified design element.

XDC Syntax

The RLOC_ORIGIN property translates to the LOC property in the synthesized design. You can specify the LOC property of RPMs by placing one of the elements of the RPM onto the target device. The other elements of the RPM will be placed relative to that location, and assigned to LOC property.

Affected Steps

- Logical to Physical Mapping
- place_design
- synth_design

See Also

[H_SET and HU_SET, page 221](#)

[RLOC, page 330](#)

[RLOCS, page 334](#)

[RPM, page 341](#)

[RPM_GRID, page 342](#)

[U_SET, page 352](#)

ROUTE_STATUS

ROUTE_STATUS is a read-only property that is assigned to nets by the Vivado router to reflect the current state of the routing on the net.

The property can be queried by the individual net, or group of nets, using the `get_property` or `report_property` commands. The property is used by the `report_route_status` command to return the ROUTE_STATUS of the whole design.

Architecture Support

All architectures.

Applicable Objects

- Nets (`get_nets`)

Values

- **ROUTED**: The net is fully placed and routed.
- **PARTIAL**: All pins and/or ports for the net are placed and some of the net is routed, but portions of the net are unrouted and `route_design` should be run.
- **UNPLACED**: The route has some unplaced pins or ports, and `place_design` should be run to complete the placement.
- **UNROUTED**: All pins and/or ports for the net are placed, but no route data exists on the net, and `route_design` should be run to complete the route.
- **INTRASITE**: The entire route is completed within the same Site on the target device, and no routing resources were required to complete the connection. This is not an error.
- **NOLOADS**: The route either has no logical loads, or has no routable load pins, and so needs no routing. This is not an error.
- **NODRIVER**: The route either has no logical driver, or has no routable driver, and so needs no routing. This is a design error.
- **HIERPORT**: The route is connected to a top-level hierarchical port that either has no routable loads or no routable drivers. This is not an error.
- **ANTENNAS**: The route has at least one antenna (a branch leaf that connects to a site pin, but that site pin does not show that it is connected to this logical net) or the route has at least one island (a section of routing that is not connected to any of the site pins associated with the logical net). This is a routing error.

- **CONFLICTS:** The router has one or more of the following routing errors:
 - Routing conflict: One or more of the nodes in this route are also used in some other route, or another branch of this route.
 - Site pin conflict: The logical net that is connected to the given site pin from inside the site is different from the logical net that is connected via the route to the outside of the site.
 - Invalid site conflict: The route connects to a site pin on a site where the programming of the site is in an invalid state, making it impossible to determine if the route is connected correctly within the site.
- **ERROR:** There was an internal error in determining the route status.
- **NONET:** The net object specified for route status does not exist, or could not be found as entered.
- **NOROUTE:** No routing object could be retrieved for the specified net due to an error.
- **NOROUTESTORAGE:** No route storage object is available for this device due to an error.
- **UNKNOWN:** The state of the route can not be calculated due to an error.

Syntax

The ROUTE_STATUS property is an enumerated property with one of the preceding property values. It is a read-only property assigned by the Vivado router and cannot be directly modified.

Affected Steps

- Route Design

RPM

The RPM property is a read-only property assigned to the logic elements of a set as defined by the H_SET, HU_SET, or U_SET property in the RTL source files.

When RLOC is also present in the RTL source files, the H_SET, HU_SET, and U_SET properties get translated to a read-only RPM property on cells in the synthesized netlist. The HU_SET and U_SET property are visible on the RTL source file in the Text editor in the Vivado Design Suite. However, in the Properties window of a cell object, the RPM property is displayed. For more information on using these properties, and defining RPMs, refer to the *Vivado Design Suite User Guide: Using Constraints* (UG903) [Ref 19].

Architecture Support

All architectures.

Applicable Objects

- Cells in the synthesized design (`get_cells`)

Values

- `<NAME>`: The name of the RPM as it is derived from the set definition by the presence of the RLOC property together with the H_SET, HU_SET, or U_SET property in the RTL source files.

Syntax

The RPM property is a read-only property derived during synthesis of an RTL design with RLOC defined together with one of H_SET, HU_SET, or U_SET to define the RPM. The RPM property cannot be directly defined or edited.

See Also

[H_SET and HU_SET, page 221](#)

[RLOC, page 330](#)

[RLOCS, page 334](#)

[RLOC_ORIGIN, page 336](#)

[RPM_GRID, page 342](#)

[U_SET, page 352](#)

RPM_GRID

The RPM_GRID property defines the RLOC grids as absolute coordinates instead of relative coordinates. The RPM_GRID system is used for heterogeneous RPMs where the cells belong to different site types (such as a combination of SLICES, block RAM, and DSP). Because the cells may occupy sites of various sizes, the RPM_GRID system uses absolute RPM_GRID coordinates that are derived directly from the target device.

The RPM_GRID values are visible in the Site Properties window of the Vivado Integrated Design Environment (IDE) when a specific site is selected in the Device window. The coordinates can also be queried with Tcl commands using the RPM_X and RPM_Y site properties. For more information on using the RPM_GRID property, and defining RPMs with absolute coordinates, refer to the *Vivado Design Suite User Guide: Using Constraints* (UG903) [Ref 19].

Architecture Support

All architectures.

Applicable Objects

- Cells (`get_cells`)

Values

- **"GRID"**: The RPM_GRID property and GRID keyword combine to inform the Vivado Design Suite that the specified RLOCs are absolute grid coordinates from the target device, rather than the relative coordinates usually specified by RLOC.

Syntax

Verilog Syntax

Place the Verilog attribute immediately before the module or instantiation. Specify as follows:

```
(* RPM_GRID = "GRID" *)
```

Verilog Example

```
module iddr_regs
(
  input  clk, d,
  output y, z
);
```

```
(* RLOC = "X130Y195" *) IDDR ireg (.C(clk_i), .D(d), .Q1(q1), .Q2(q2));
defparam ireg.DDR_CLK_EDGE = "SAME_EDGE";
(* RLOC = "X147Y194" *) FD qlreg (.C(clk_i), .D(q1), .Q(y));
(* RLOC = "X147Y194", RPM_GRID = "GRID" *) FD q2reg (.C(clk_i), .D(q2), .Q(z));

endmodule // iddr_regs
```

VHDL Syntax

To use the RPM_GRID system, first define the attribute, then add the attribute to one of the design elements:

```
attribute RPM_GRID of ram0 : label is "GRID";
```

Declare the VHDL constraint as follows:

```
attribute RPM_GRID : string;
```

Specify the VHDL constraint as follows:

```
attribute RPM_GRID of {component_name | entity_name} :
{component|entity} is "GRID";
```

XDC Syntax

The RPM_GRID property is assigned in the RTL source file, and cannot be defined in XDC files or with Tcl commands. However, for XDC macros, the corresponding construct is the `-absolute_grid` option used with the `update_macros` command.

Affected Steps

- Logical to Physical Mapping
- place_design
- synth_design

See Also

[H_SET and HU_SET, page 221](#)

[RLOC, page 330](#)

[RLOCS, page 334](#)

[RLOC_ORIGIN, page 336](#)

[RPM, page 341](#)

[U_SET, page 352](#)

SEVERITY

The SEVERITY property lets you change the severity assigned to individual design rule checks (DRC) in the Vivado Design Suite when running Report DRC. For more information on Running DRCs, see this [link](#) in the *Vivado Design Suite User Guide: System-Level Design Entry* (UG895) [Ref 15].

You can set the severity of both built-in and custom DRCs. For information on writing custom design rule checks, see this [link](#) in the *Vivado Design Suite User Guide: Using Tcl Scripting* (UG894) [Ref 14].

As an example, the following command can be used to downgrade an Error to a Warning.

```
set_property SEVERITY {Warning} [get_drc_checks REQP-83]
```



IMPORTANT: *Although Vivado allows you to disable and downgrade the severity of the built-in DRC objects, this practice is highly discouraged as it can cause unpredictable results and could potentially cause permanent damage to the device.*

To restore the DRC objects to the default setting, use the [reset_drc_check](#) Tcl command. Built-in DRC checks are returned to their default settings as defined by the Vivado tool. Custom DRCs are returned to their default settings as defined by the [create_drc_check](#) command that created it.

Architecture Support

All architectures.

Applicable Objects

- Design Rule Check objects ([get_drc_checks](#))

Values

- **Fatal**
- **Error**
- **{Critical Warning}**
- **Warning**
- **Advisory**

Syntax

Verilog and VHDL Syntax

Not applicable

XDC Syntax

```
set_property SEVERITY {<VALUE>} [get_drc_checks <id>]
```

Where

- **<VALUE>** is one of the recognized DRC severity levels in the Vivado tool: Advisory, Warning, {Critical Warning}, Error, Fatal.
- **<id>** is the DRC ID recognized by the Vivado Design Suite.

XDC Syntax Example

```
set_property SEVERITY {Critical Warning} [get_drc_checks RAMW-1]
```

Affected Steps

- report_drc
- write_bitstream

See Also

[IS_ENABLED](#), page 256

SLEW

SLEW specifies output buffer slew rate for output buffers configured with I/O standards that support programmable output slew rates.

Architecture Support

All architectures.

Applicable Objects

- Ports (`get_ports`)
 - Output or bidirectional ports connected
- Cells (`get_cells`)
 - Output Buffers (all OBUF variants)

Values

- **SLOW** (default)
- **MEDIUM**: for UltraScale architecture, only available on high-performance (HP) I/Os.
- **FAST**

Syntax

Verilog Syntax

To set this attribute when inferring I/O buffers, place the proper Verilog attribute syntax before the top-level output port declaration.

```
(* DRIVE = "{SLOW|FAST}" *)
```

Verilog Syntax Example

```
// Sets the Slew rate to be FAST  
(* SLEW = "FAST" *) output FAST_DATA,
```

VHDL Syntax

To set this attribute when inferring I/O buffers, place the proper VHDL attribute syntax before the top-level output port declaration.

Declare the VHDL attribute as follows:

```
attribute SLEW : string;
```

Specify the VHDL attribute as follows:

```
attribute SLEW of port_name : signal is value;
```

Where

- `port_name` is a top-level output port.

VHDL Syntax Example

```
FAST_DATA : out std_logic;  
attribute SLEW : string;  
-- Sets the Slew rate to be FAST  
attribute SLEW of STATUS : signal is "FAST";
```

XDC Syntax

```
set_property SLEW value [get_ports port_name]
```

Where

- `port_name` is an output or bidirectional port.

XDC Syntax Example

```
# Sets the Slew rate to be FAST  
set_property SLEW FAST [get_ports FAST_DATA]
```

Affected Steps

- I/O Planning
- Report Noise
- Report Power

See Also

Refer to the following design elements in the *Vivado Design Suite 7 Series FPGA and Zynq-7000 SoC Libraries Guide* (UG953) [Ref 25] or the *UltraScale Architecture Libraries Guide* (UG974) [Ref 26].

- OBUF
- OBUFT
- IOBUF
- IOBUF_DCIEN
- IOBUF_INTERMDISABLE

SYNTH_CHECKPOINT_MODE

When generating the output products for a Vivado IP integrator block design file (.bd), you can choose how the block design is synthesized in coordination with the top-level design. Refer to this [link](#) in *Vivado Design Suite User Guide: Designing IP Subsystems Using IP Integrator* (UG994) [Ref 27] for more information. Using the SYNTH_CHECKPOINT_MODE you can specify that the block design will be synthesized as part of the top-level design, during global synthesis. Do this by setting SYNTH_CHECKPOINT_MODE to NONE, disabling the generation of the OOC synthesis checkpoint for the block design.



IMPORTANT: When SYNTH_CHECKPOINT_MODE is set to NONE, the Vivado tool automatically sets the [GENERATE_SYNTH_CHECKPOINT](#) property to FALSE, or 0, to disable the OOC flow and the generation of the synthesized DCP output product for BD files.

You can also choose that the block design should be synthesized out-of-context (OOC) from the rest of the design, by setting the SYNTH_CHECKPOINT_MODE property to either SINGULAR or HIERARCHICAL:

- SINGULAR specifies that the block design will be synthesized as a single unit, and written to a single DCP. In the Vivado IDE this option is referred to as **Out-of-context per Block Design**.
- HIERARCHICAL specifies that all IP used in the block design will be synthesized, and written to separate DCP files for each IP. In the Vivado IDE this option is referred to as **Out-of-context per IP**. This is the default mode.

This property will become read-only if the IP is locked for any reason. In this case, you can run **Reports > Report IP Status** in the Vivado IDE, or run the [report_ip_status](#) Tcl command to see why the IP is locked. You will not be able to generate the DCP without first updating the IP to the latest version in the Vivado IP catalog. Refer to this [link](#) in the *Vivado Design Suite User Guide: Designing with IP* (UG896) [Ref 16] for more information.

Architecture Support

All architectures.

Applicable Objects

- Block Design Files (BD)
- (get_files)

Values

- **None:** Indicates that the block design should be synthesized along with the rest of the design. This is known as global synthesis.
- **Singular:** Indicates that the entire block design should be synthesized as an out-of-context block.
- **Hierarchical:** Indicates that each IP used in the block design should be synthesized separately. That is each IP should be synthesized out-of-context to maximize the use of the synthesis cache whenever re-synthesis is needed. This is the **default** mode.

Syntax

Verilog and VHDL Syntax

Not applicable

XDC Syntax

The following command examples show setting the various SYNTH_CHECKPOINT_MODE values, and using the `generate_targets` Tcl command to create the output.

Global Synthesis:

```
set_property SYNTH_CHECKPOINT_MODE NONE [get_files <filename>.bd]
generate_target all [get_files <filename>.bd]
```

OOO per IP:

```
set_property SYNTH_CHECKPOINT_MODE HIERARCHICAL [get_files <filename>.bd]
generate_target all [get_files <filename>.bd]
```

OOO per block design:

```
set_property SYNTH_CHECKPOINT_MODE SINGULAR [get_files <filename>.bd]
generate_target all [get_files <filename>.bd]
```

Where

- `<filename>` is the filename of a block design (BD).

XDC Syntax Example

```
set_property SYNTH_CHECKPOINT_MODE SINGULAR [get_files *.bd]
generate_target all [get_files *.bd]
```

Affected Steps

- Synthesis
- Implementation

See Also

[GENERATE_SYNTH_CHECKPOINT](#), page 219

U_SET

Groups design elements with attached Relative Location (RLOC) constraints that are distributed throughout the design hierarchy into a single set.

U_SET is an attribute within the HDL design source files, and does not appear in the synthesized or implemented design. U_SET is used when defining Relatively Placed Macros, or RPMs in the RTL design. For more information on using these properties, and defining RPMs, refer to the *Vivado Design Suite User Guide: Using Constraints* (UG903) [Ref 19].

While H_SET or HU_SET are used to define sets of logic elements based on the design hierarchy, you can manually create a User-defined set of logic elements, or U_SET, that is not dependant on the hierarchy of the design.

When RLOC is also present in the RTL source files, the H_SET, HU_SET, and U_SET properties get translated to a read-only RPM property on cells in the synthesized netlist. The HU_SET and U_SET property are visible on the RTL source file in the Text editor in the Vivado Design Suite. However, in the Properties window of a cell object, the RPM property is displayed.



IMPORTANT: *When attached to hierarchical modules, the U_SET constraint propagates downward through the hierarchy to any primitive symbols that are assigned RLOC constraints.*

Architecture Support

All architectures.

Applicable Objects

The U_Set constraint may be used in one or more of the following design elements, or categories of design elements. Refer to the *Vivado Design Suite 7 Series FPGA and Zynq-7000 SoC Libraries Guide* (UG953) [Ref 25] or the *UltraScale Architecture Libraries Guide* (UG974) [Ref 26] for more information on the specific design elements:

- Registers
- Macro Instance
- RAMS*
- RAMD*
- RAMB*
- DSP48*

Values

- `<NAME>`: A unique name for the U_SET.

Syntax

Verilog Syntax

This is a Verilog attribute used in combination with the RLOC property to define the set content of a hierarchical block that will define an RPM in the synthesized netlist. Place the Verilog attribute immediately before the instantiation of a logic element.

```
(* RLOC = "X0Y0", HU_SET = "h0" *) FD sr0 (.C(clk), .D(sr_1n), .Q(sr_0));
```

Verilog Example

The following Verilog module defines RLOC and U_SET properties for the shift register flops in the module.

```
module ffs (
    input  clk,
    input  d,
    output q
);

    wire  sr_0, sr_0n;
    wire  sr_1, sr_1n;
    wire  sr_2, sr_2n;
    wire  sr_3, sr_3n;
    wire  sr_4, sr_4n;
    wire  sr_5, sr_5n;
    wire  sr_6, sr_6n;
    wire  sr_7, sr_7n;

    wire  inr, inrn, outr;

    inv i0 (sr_0, sr_0n);
    inv i1 (sr_1, sr_1n);
    inv i2 (sr_2, sr_2n);
    inv i3 (sr_3, sr_3n);
    inv i4 (sr_4, sr_4n);
    inv i5 (sr_5, sr_5n);
    inv i6 (sr_6, sr_6n);
    inv i7 (sr_7, sr_7n);
    inv i8 (inr, inrn);

    (* RLOC = "X0Y0", U_SET = "Uset0" *) FD sr0 (.C(clk), .D(sr_1n), .Q(sr_0));
    (* RLOC = "X0Y0", U_SET = "Uset0" *) FD sr1 (.C(clk), .D(sr_2n), .Q(sr_1));
    (* RLOC = "X0Y1", U_SET = "Uset0" *) FD sr2 (.C(clk), .D(sr_3n), .Q(sr_2));
    (* RLOC = "X0Y1", U_SET = "Uset0" *) FD sr3 (.C(clk), .D(sr_4n), .Q(sr_3));
    (* RLOC = "X0Y0", U_SET = "Uset1" *) FD sr4 (.C(clk), .D(sr_5n), .Q(sr_4));
    (* RLOC = "X0Y0", U_SET = "Uset1" *) FD sr5 (.C(clk), .D(sr_6n), .Q(sr_5));
    (* RLOC = "X0Y1", U_SET = "Uset1" *) FD sr6 (.C(clk), .D(sr_7n), .Q(sr_6));
    (* RLOC = "X0Y1", U_SET = "Uset1" *) FD sr7 (.C(clk), .D(inrn), .Q(sr_7));
```

```
(* LOC = "SLICE_X0Y0" *) FD inq (.C(clk), .D(d), .Q(inr));
FD outq (.C(clk), .D(sr_0n), .Q(outr));

assign q = outr;

endmodule // ffs
```

Unlike the HU_SET property, which applies to the level of hierarchy it is defined in, the U_SET property transcends hierarchy. In this case, the following top-level module defines three instances of the ffs module, but results in only two U_SETS being created: Uset_0 and Uset_1, which contain Flops from all three ffs module instances defined below:

```
module top (
    input  clk,
    input  d,
    output q
);

    wire  c1, c2;

    ffs u0 (clk, d, c1);
    ffs u1 (clk, c1, c2);
    ffs u2 (clk, c2, q);

endmodule // top
```

VHDL Syntax

Declare the VHDL attribute as follows:

```
attribute U_SET : string;
```

Specify the VHDL constraint as follows:

```
attribute U_SET of {component_name | entity_name | label_name} :
{component|entity|label} is "NAME";
```

Where:

- {component_name | entity_name | label_name} is a choice of one design element.
- {component | entity | label} is the instance ID of the design element.
- "NAME" is the unique set name to give to the U_SET.

XDC Syntax

The U_SET property can not be defined using XDC constraints. The U_SET property, when present on logic elements with the RLOC property, defines relatively placed macros (RPMs), and results in the read-only RPM property in the netlist of synthesized designs.



TIP: You can use the `create_macro` and `update_macro` commands to define macro objects in the Vivado Design Suite, that act like RPMs within the design. Refer to the Vivado Design Suite Tcl Command Reference Guide (UG835) [Ref 13] for more information on these commands.

Affected Steps

- Design Floorplanning
- place_design
- synth_design

See Also

[KEEP_HIERARCHY](#), page 263

[H_SET](#) and [HU_SET](#), page 221

[RLOC](#), page 330

UNAVAILABLE_DURING_CALIBRATION

For UltraScale architecture, the UNAVAILABLE_DURING_CALIBRATION property disables a DRC error message to report that BITSlice0 is not available during the built-in self-calibration (BISC) process.

IDELAY/ODELAY and RX_BITSLICE/TX_BITSLICE/RXTX_BITSLICE support TIME mode for DELAY_FORMAT that provides more precise delays by continuously adjusting the alignment. When TIME mode is used for IDELAY/ODELAY and native primitives, BITSlice_0 is used during the BISC process. Component logic connected to BITSlice_0 might not be available during the BISC process. In this case, the Vivado tool will issue a DRC violation to indicate that input routing and logic associated with BITSlice_0 within a nibble will be unavailable during the BISC operation. Refer to the DELAY_FORMAT attribute in the *UltraScale Architecture SelectIO Resources User Guide* (UG571) [Ref 8] for more information.

If these restrictions do not affect a design, the DRC may be disabled with the UNAVAILABLE_DURING_CALIBRATION property.



TIP: This property must be assigned as an XDC constraint. It is not supported in HDL source files.

Architecture Support

UltraScale architecture.

Applicable Objects

- Ports (`get_ports`)

Values

- **TRUE:** Disable reporting of the DRC error message related to the BISC process.
- **FALSE:** Do not disable the reporting of the DRC error message (default).

Syntax

Verilog Syntax

Not applicable.

VHDL Syntax

Not applicable.

XDC Syntax

```
set_property UNAVAILABLE_DURING_CALIBRATION TRUE [get_ports <port_name>]
```

Affected Steps

DRC

USE_DSP

The USE_DSP property directs the Vivado Design Suite to synthesize mathematical modules into DSP blocks on the targeted device.



TIP: *USE_DSP48 is deprecated, and should be replaced by USE_DSP.*

By default, multipliers (mults), mult-add, mult-sub, mult-accumulate type structures are assigned into DSP blocks. However, adders, subtractors, and accumulators can also go into DSP blocks, but by default are implemented with logic instead. The USE_DSP attribute overrides the default behavior and defines these structures using DSPs.

DSPs can also be used to implement many other logic functions, beyond mathematics, such as counters, multiplexers, and shift registers. However, for complex modules such as multiplexers, you need to manually instantiate DSPs.

This property can be placed in the RTL as an attribute on signals, for example:

```
(* use_dsp = "yes" *) module test(clk, in1, in2, out1);
```

You can apply USE_DSP to a module in the RTL source, but it only applies to the module it is specified on. You can also apply it to hierarchical cells in the design as an XDC constraint.

Architecture Support

All devices.

Applicable Objects

This attribute can be placed in the RTL on signals, architectures and components, entities and modules. The priority is as follows:

1. Signals
2. Architectures and components
3. Modules and entities

Values

- **YES:** Use the DSP blocks to implement mathematical functions.
- **NO:** Do not change the default behavior of Vivado synthesis.
- **LOGIC:** For UltraScale architecture only. Use the DSP blocks to implement large/wide XOR functions.

Syntax

Verilog Syntax

```
(* use_dsp = "yes" *) module test(clk, in1, in2, out1);
```

VHDL Syntax

```
attribute use_dsp : string;  
attribute use_dsp of P_reg : signal is "no"
```

XDC Syntax

```
set_property use_dsp yes [get_cells -hier ...]
```

Affected Steps

- Synthesis

USED_IN

The USED_IN property is assigned to design files (.v, .vhd, .xdc, .tcl) in the Vivado Design Suite to indicate what stage in the FPGA design flow the files are used.

For example, you could use the USED_IN property to specify an XDC file for use by the Vivado synthesis tool, but not for use in implementation. You could also specify HDL source files (.v or .vhd) as USED_IN simulation, but not for use in synthesis.



TIP: The `USED_IN_SYNTHESIS`, `USED_IN_SIMULATION`, and `USED_IN_IMPLEMENTATION` properties are related to the `USED_IN` property, and are automatically converted by the tool to `USED_IN` (`synthesis`, `simulation`, `implementation`) as appropriate.

You can also use the more granular values to specify an un-managed Tcl file to be USED_IN `opt_design` or `place_design`, rather than simply used in implementation.

Architecture Support

All architectures.

Applicable Objects

- Files

Values

- synthesis
- implementation
- simulation
- out_of_context
- opt_design
- power_opt_design
- place_design
- phys_opt_design
- route_design
- write_bitstream
- post_write_bitstream
- synth_blackbox_stub

- test_bench
- board
- single_language

Syntax

Verilog and VHDL Syntax

Not applicable

XDC Syntax

```
set_property USED_IN {<value>} [get_files <files>]
```

Where

- *<value>* specifies one or more of the valid USED_IN values.
- *<files>* is the name or names of the files to set the USED_IN property.

XDC Syntax Example

```
# Designates the specified files as used in simulation  
set_property USED_IN {synthesis simulation} [get_files *.vhdl]
```

Affected Steps

- Synthesis
- Simulation
- Implementation
- Bitstream generation

USER_CLOCK_ROOT

Used to assign the clock driver, or root, to a specific clock region or Pblock on the target part.

The USER_CLOCK_ROOT property is intended to help manage clock skew across the device. By default, the place and route tools will automatically assign a clock root to achieve the best timing characteristics for the design. The tool assigned clock root is defined in the read-only [CLOCK_ROOT](#) property. The USER_CLOCK_ROOT property lets you manually assign the clock root.



IMPORTANT: *The USER_CLOCK_ROOT property can be set on a global clock net, and can only be assigned to the net segment directly driven by the global clock buffer (BUFG).*

The USER_CLOCK_ROOT property is validated and used during clock resource placement, so the assignment should be made prior to placement. However, if you assign the property after placement, you will need to rerun placement to implement the clock root and affect the design.

Due to a more flexible clocking architecture, designs that target UltraScale devices and UltraScale+ devices require a two-step process for routing global clocks. First the Vivado placer assigns the routing resources required to route the global clocks from the clock source to the destination clock regions (CLOCK_ROOT or USER_CLOCK_ROOT). Next the Vivado router fills in the routing gaps on the clock nets.

The global clock routing is handled automatically during implementation. However in cases where the USER_CLOCK_ROOT property on a clock net has been changed after implementation, the Vivado tool may require the [update_clock_routing](#) command to properly reroute the clock nets.

Architecture Support

UltraScale architecture.

Applicable Objects

- Global clock net (`get_nets`) directly connected to the output of a global clock buffer.

Value

- `<clock_region | pblock>`: Specifies as the name of a clock region on the target part, or a defined Pblock in the current design. The clock region can be specified by name or passed as a `clock_region` object by the [get_clock_regions](#) command. Similarly, the Pblock can be specified by name or returned by the [get_pblocks](#) command.

- `<objects>`: Specified as one or more clock nets, or net segments.

Syntax

Verilog and VHDL Syntax

Not applicable

XDC Syntax

```
set_property USER_CLOCK_ROOT <clock_region | pblock> <objects>
```

XDC Syntax Examples:

```
set_property USER_CLOCK_ROOT X1Y0 [get_nets {clk1 clk2}]  
set_property USER_CLOCK_ROOT [get_clock_regions X0Y0] [get_nets {clk1 clk2}]
```



TIP: The clock net can also be defined using the global clock buffer instance, or output pin, as shown in the following example:

```
set_property USER_CLOCK_ROOT X1Y0 [get_nets -of [get_pins bufferName/O]]
```

Affected Steps

- Placement
- Routing

See Also

[CLOCK_BUFFER_TYPE](#), page 164

[CLOCK_REGION](#), page 173

[CLOCK_ROOT](#), page 175

USER_CROSSING_SLR

When placing design elements on stacked silicon interconnect (SSI) devices, you can use [USER_SLR_ASSIGNMENT](#), `USER_CROSSING_SLR`, and [USER_SLL_REG](#) properties to manage logic partitioning, and the behavior of the Vivado placement tool. SSI devices consist of multiple super logic regions (SLRs), joined by interposer connections called super long lines (SLLs). For more information on placing and routing in and across SLRs, refer to this [link](#) in the *UltraFast Design Methodology Guide for the Vivado Design Suite* (UG949) [Ref 24].

`USER_CROSSING_SLR` is a boolean property that indicates that a net is allowed to cross an SLR boundary, or that the net should not cross the SLR boundary. The constraint can be applied to either nets or pins. If the `USER_CROSSING_SLR` is set to 1, the net can cross the SLR boundary through the SLL channel. When set to 0, the net should not cross the SLR boundary.



IMPORTANT: A value of 0 can be used on any pin or net segment to indicate the net should not cross the boundary. A value of 1 can only be applied to single-fanout pipeline register connections.

To manage placement across SLRs, start with `USER_SLR_ASSIGNMENT` to assign logic to an SLR or group, add `USER_CROSSING_SLR` to control which net segment in the logic crosses the SLR boundary. Add `USER_SLL_REG` if needed.

`USER_CROSSING_SLR=1` has no conflict with `USER_SLR_ASSIGNMENT` as it is used after the floorplanning placement phase. `USER_CROSSING_SLR=0` has lower priority than `USER_SLR_ASSIGNMENT`

`USER_CROSSING_SLR` has higher priority than `USER_SLL_REG`. When `USER_CROSSING_SLR` is in conflict with `USER_SLL_REG`, the latter property is ignored.

However, if both pins of a register with `USER_SLL_REG` (true) also have `USER_CROSSING_SLR` (true), but the source cell of Reg/D and the load cell of Reg/Q are placed in the same SLR, then both `USER_SLL_REG` and `USER_CROSSING_SLR` should be ignored.

Architecture Support

All architectures.

Applicable Objects

- Nets (`get_nets`)
- Pins (`get_pins`)

Value

- **Null** (or `""`): Indicates that the property is found on the net or pin, but that the property value has not been set to either TRUE or FALSE, or has been unset.
- **True** (or 1): The net connected to the pin will be routed onto SLL channel if necessary for placement purposes.
- **False** (or 0): The net connected to the pin will be routed inside an SLR.

Syntax

Verilog and VHDL Syntax

Not applicable

XDC Syntax

```
set_property USER_CROSSING_SLR <value> [get_nets <net_name>]
```

Where:

- `<value>` is the specified value for the property of NULL, TRUE, or FALSE.
- `<net_name>` specifies the name of the net to assign the property to.

XDC Example 1:

```
set_property USER_CROSSING_SLR 0 [get_nets net_A]
```

Affected Steps

- Placement

See Also

[USER_SLL_REG](#), page 366

[USER_SLR_ASSIGNMENT](#), page 368

USER_SLL_REG

Stacked silicon interconnect (SSI) devices consist of multiple super logic regions (SLRs), joined by interposer connections called super long lines (SLLs). Paths crossing between SLRs through SLLs can present timing closure challenges.

Using SLL Laguna TX/RX registers can improve correlation between estimated and routed delays for nets that cross between SLR boundaries. Setting the USER_SLL_REG property on a register where the source cell of Reg/D and the load cell of Reg/Q are placed in different SLRs. Like the IOB property, the USER_SLL_REG property directs the Vivado placer to place the register into a nearby Laguna TX_REG or RX_REG site instead of the fabric if connectivity allows. For more information on placing and routing in and across SLRs, refer to this [link](#) in the *UltraFast Design Methodology Guide for the Vivado Design Suite* (UG949) [Ref 24].



TIP: *The property is ignored when the nets do not cross an SLR boundary, or both the driver and the load are crossing the same SLR boundary, or the Red/Q net has loads in multiple SLRs.*

For an FD cell with USER_SLL_REG property set to true, the placer will attempt to place the cell on a nearby LAGUNA site if the net connected to FD/D or FD/Q crosses an SLR boundary. The property will be ignored when:

- none of the nets connected to FD/D or FD/Q cross an SLR boundary,
- both nets connected to FD/D or FD/Q cross an SLR boundary,
- FD/Q net crosses an SLR boundary and has loads in 2 different SLRs.

One technique to improve the placement of FD cells with the USER_SLL_REG property to a Laguna TX_REG or RX_REG, and decrease the algorithm runtime, is to constrain the FD cell to a clock region size **PBLOCK** that includes the LAGUNA sites.



IMPORTANT: *This property is considered a guideline which the placer will attempt to follow, but may be overridden to achieve a valid placement result.*

Architecture Support

UltraScale architecture.

Applicable Objects

- Cells (`get_cells`) as hierarchical modules or logical instances.

Value

- **True** (or 1): The Vivado placer will place (during detail placement) the FD cell on a LAGUNA site if the net connected to FD/D or FD/Q crosses an SLR boundary.
- **False** (or 0): Do not place the register into a LAGUNA site.

Syntax

Verilog and VHDL Syntax

Not applicable

XDC Syntax

```
set_property USER_SLL_REG <True | False> <objects>
```

XDC Example:

```
set_property USER_SLL_REG 1 [get_cells {cell1 cell2}]
```

The placer will try to place cell1 and cell2 into Laguna registers at the SLR boundary.

Affected Steps

- Placement

See Also

[IOB, page 243](#)

[PBLOCK, page 300](#)

[USER_CROSSING_SLR, page 364](#)

[USER_SLR_ASSIGNMENT, page 368](#)

USER_SLR_ASSIGNMENT

When placing design elements on stacked silicon interconnect (SSI) devices, you can use `USER_SLR_ASSIGNMENT`, `USER_CROSSING_SLR`, and `USER_SLL_REG` properties to manage logic partitioning, and the behavior of the Vivado placement tool. SSI devices consist of multiple super logic regions (SLRs), joined by interposer connections called super long lines (SLLs). For more information on placing and routing in and across SLRs, refer to this [link](#) in the *UltraFast Design Methodology Guide for the Vivado Design Suite* (UG949) [Ref 24].

The `USER_SLR_ASSIGNMENT` property lets you specify the placement of cells into a defined super logic region (SLR), or grouped together into the same SLR without defining a specific SLR. The property has two forms, as defined in the **Value** section below: `SLRn` which defines a specific SLR to place the cells into, or `group_name` which groups cells together to be placed into the same SLR, though not a specific SLR.



IMPORTANT: *This property is considered a guideline which the placer will attempt to follow, but may override to achieve a valid placement result.*

To manage placement across SLRs, start with `USER_SLR_ASSIGNMENT` to assign logic to an SLR or group, add `USER_CROSSING_SLR` to control which net segment in the logic crosses the SLR boundary, and add `USER_SLL_REG` if necessary. `USER_SLR_ASSIGNMENT` has the highest priority. Use that together with `USER_CROSSING_SLR` to control individual nets/pins crossing the SLR boundary.

Architecture Support

All architectures.

Applicable Objects

- Cells (`get_cells`) as hierarchical modules.

Value

- `SLRn`: Where 'n' is an integer representing a specific SLR in a device. The placer will attempt to keep the contents of the hierarchical cell within the specified SLR.
- `group_name`: This is a unique string value that can be assigned to one or more hierarchical cells or modules. The placer will try to place the cells or module with a common `group_name` into a single SLR, but the specific SLR is not important.

Syntax

Verilog and VHDL Syntax

Not applicable

XDC Syntax

```
set_property USER_SLR_ASSIGNMENT <SLRn | group_name> <objects>
```

XDC Example 1:

```
set_property USER_SLR_ASSIGNMENT SLR1 [get_cells {cell1 cell2}]
```

The placer will try to avoid partitioning cells cell1 and cell2 and try to place them in SLR1.

XDC Example 2:

```
set_property USER_SLR_ASSIGNMENT group_1 [get_cells {cell1 cell2}]
```

The placer will try to avoid partitioning cell1 and cell2 and try to place them in the same SLR, but the specific SLR is not important.

Affected Steps

- Placement

See Also

[USER_CROSSING_SLR, page 364](#)

[USER_SLL_REG, page 366](#)

VCCAUX_IO

VCCAUX_IO specifies the operating voltage of the VCCAUX_IO rail for a given I/O.

DRCs are available to ensure that VCCAUX_IO property assignments are correct:

- VCCAUXIOBT (warning): ensures that ports with VCCAUX_IO values of NORMAL or HIGH are only placed in HP banks.
- VCCAUXIOSTD (warning): ensures that ports with VCCAUX_IO values of NORMAL or HIGH do not use IOSTANDARDS that are only supported in HR banks.
- VCCAUXIO (error): ensures that ports with VCCAUX_IO values of NORMAL are not constrained/placed in the same bank as a port with a VCCAUX_IO value of HIGH.

Architecture Support

7 series FPGAs and Zynq-7000 SoC devices on High Performance (HP) bank I/O only.

Applicable Objects

- Ports (`get_ports`)

Values

- **DONTCARE** (default)
- **NORMAL**
- **HIGH**

Syntax

Verilog Syntax

To set this attribute, place the proper Verilog attribute syntax before the top-level output port declaration.

```
(* VCCAUXIO = "{DONTCARE|NORMAL|HIGH}" *)
```

Verilog Syntax Example

```
// Specifies a "HIGH" voltage for the VCCAUX_IO rail connected to this I/O  
(* VCCAUX_IO = "HIGH" *) input ACT3,
```

VHDL Syntax

To set this attribute, place the proper VHDL attribute syntax before the top-level output port declaration.

Declare the VHDL attribute as follows:

```
attribute VCCAUX_IO : string;
```

Specify the VHDL attribute as follows:

```
attribute VCCAUX_IO of port_name : signal is value;
```

Where

- `port_name` is a top-level port.

VHDL Syntax Example

```
ACT3 : in std_logic;  
attribute VCCAUX_IO : string;  
-- Specifies a HIGH voltage for the VCCAUX_IO rail connected to this I/O  
attribute VCCAUX_IO of ACT3 : signal is "HIGH";
```

XDC Syntax

```
set_property VCCAUX_IO value [get_ports port_name]
```

Where

- `port_name` is a top-level port.

XDC Syntax Example

```
# Specifies a HIGH voltage for the VCCAUX_IO rail connected to this I/O  
set_property VCCAUX_IO HIGH [get_ports ACT3]
```

Affected Steps

- I/O Planning
- `place_design`
- `report_power`

Additional Resources

Xilinx Resources

For support resources such as Answers, Documentation, Downloads, and Forums, see [Xilinx Support](#).

Solution Centers

See the [Xilinx Solution Centers](#) for support on devices, software tools, and intellectual property at all stages of the design cycle. Topics include design assistance, advisories, and troubleshooting tips.

Documentation Navigator and Design Hubs

Xilinx Documentation Navigator provides access to Xilinx documents, videos, and support resources, which you can filter and search to find information. To open the Xilinx Documentation Navigator (DocNav):

- From the Vivado IDE, select **Help > Documentation and Tutorials**.
- On Windows, select **Start > All Programs > Xilinx Design Tools > DocNav**.
- At the Linux command prompt, enter `docnav`.

Xilinx Design Hubs provide links to documentation organized by design tasks and other topics, which you can use to learn key concepts and address frequently asked questions. To access the Design Hubs:

- In the Xilinx Documentation Navigator, click the **Design Hubs View** tab.
- On the Xilinx website, see the [Design Hubs](#) page.

Note: For more information on Documentation Navigator, see the [Documentation Navigator](#) page on the Xilinx website.

References

The following documents provide supplemental material to this guide:

1. *7 Series FPGA Configuration User Guide* ([UG470](#))
2. *7 Series FPGAs SelectIO Resources User Guide* ([UG471](#))
3. *7 Series FPGAs Clocking Resources User Guide* ([UG472](#))
4. *7 Series FPGAs Configurable Logic Block User Guide* ([UG474](#))
5. *7 Series FPGAs Packaging and Pinout* ([UG475](#))
6. *7 Series FPGAs and Zynq-7000 SoC XADC Dual 12-Bit 1 MSPS Analog-to-Digital Converter User Guide* ([UG480](#))
7. *UltraScale Architecture Configuration User Guide* ([UG570](#))
8. *UltraScale Architecture SelectIO Resources User Guide* ([UG571](#))
9. *UltraScale Architecture Clocking Resources User Guide* ([UG572](#))
10. *UltraScale Architecture Configurable Logic Block User Guide* ([UG574](#))
11. *UltraScale and UltraScale+ FPGAs Packaging and Pinouts Product Specification* ([UG575](#))
12. *UltraScale Architecture System Monitor Advance Specification User Guide* ([UG580](#))
13. *Vivado Design Suite Tcl Command Reference Guide* ([UG835](#))
14. *Vivado Design Suite User Guide: Using Tcl Scripting* ([UG894](#))
15. *Vivado Design Suite User Guide: System-Level Design Entry* ([UG895](#))
16. *Vivado Design Suite User Guide: Designing with IP* ([UG896](#))
17. *Vivado Design Suite User Guide: I/O and Clock Planning* ([UG899](#))
18. *Vivado Design Suite User Guide: Synthesis* ([UG901](#))
19. *Vivado Design Suite User Guide: Using Constraints* ([UG903](#))
20. *Vivado Design Suite User Guide: Implementation* ([UG904](#))
21. *Vivado Design Suite User Guide: Hierarchical Design* ([UG905](#))
22. *Vivado Design Suite User Guide: Design Analysis and Closure Techniques* ([UG906](#))
23. *Vivado Design Suite User Guide: Programming and Debugging* ([UG908](#))
24. *UltraFast Design Methodology Guide for the Vivado Design Suite* ([UG949](#))
25. *Vivado Design Suite 7 Series FPGA Libraries Guide* ([UG953](#))
26. *Vivado Design Suite UltraScale Architecture Libraries Guide* ([UG974](#))
27. *Vivado Design Suite User Guide: Designing IP Subsystems Using IP Integrator* ([UG994](#))

28. *Soft Error Mitigation Controller LogiCORE IP Product Guide* ([PG036](#))
29. *JTAG to AXI Master LogiCORE IP Product Guide* ([PG174](#))
30. *Integrated Bit Error Ratio Tester 7 Series GTX Transceivers LogiCORE IP Product Guide* ([PG132](#))
31. *Virtual Input/Output LogiCORE IP Product Guide* ([PG159](#))
32. [Vivado Design Suite Documentation](#)

Training Resources

Xilinx provides a variety of training courses and QuickTake videos to help you learn more about the concepts presented in this document. Use these links to explore related training resources:

1. [Vivado Design Suite QuickTake Video Tutorials](#)
2. [Vivado Design Suite QuickTake Video: Design Constraints Overview](#)
3. [Essentials of FPGA Design Training Course](#)
4. [Vivado Design Suite Static Timing Analysis and Xilinx Design Constraints](#)
5. [Designing with the UltraScale Architecture](#)

Please Read: Important Legal Notices

The information disclosed to you hereunder (the "Materials") is provided solely for the selection and use of Xilinx products. To the maximum extent permitted by applicable law: (1) Materials are made available "AS IS" and with all faults, Xilinx hereby DISCLAIMS ALL WARRANTIES AND CONDITIONS, EXPRESS, IMPLIED, OR STATUTORY, INCLUDING BUT NOT LIMITED TO WARRANTIES OF MERCHANTABILITY, NON-INFRINGEMENT, OR FITNESS FOR ANY PARTICULAR PURPOSE; and (2) Xilinx shall not be liable (whether in contract or tort, including negligence, or under any other theory of liability) for any loss or damage of any kind or nature related to, arising under, or in connection with, the Materials (including your use of the Materials), including for any direct, indirect, special, incidental, or consequential loss or damage (including loss of data, profits, goodwill, or any type of loss or damage suffered as a result of any action brought by a third party) even if such damage or loss was reasonably foreseeable or Xilinx had been advised of the possibility of the same. Xilinx assumes no obligation to correct any errors contained in the Materials or to notify you of updates to the Materials or to product specifications. You may not reproduce, modify, distribute, or publicly display the Materials without prior written consent. Certain products are subject to the terms and conditions of Xilinx's limited warranty, please refer to Xilinx's Terms of Sale which can be viewed at <https://www.xilinx.com/legal.htm#tos>; IP cores may be subject to warranty and support terms contained in a license issued to you by Xilinx. Xilinx products are not designed or intended to be fail-safe or for use in any application requiring fail-safe performance; you assume sole risk and liability for use of Xilinx products in such critical applications, please refer to Xilinx's Terms of Sale which can be viewed at <https://www.xilinx.com/legal.htm#tos>.

AUTOMOTIVE APPLICATIONS DISCLAIMER

AUTOMOTIVE PRODUCTS (IDENTIFIED AS "XA" IN THE PART NUMBER) ARE NOT WARRANTED FOR USE IN THE DEPLOYMENT OF AIRBAGS OR FOR USE IN APPLICATIONS THAT AFFECT CONTROL OF A VEHICLE ("SAFETY APPLICATION") UNLESS THERE IS A SAFETY CONCEPT OR REDUNDANCY FEATURE CONSISTENT WITH THE ISO 26262 AUTOMOTIVE SAFETY STANDARD ("SAFETY DESIGN"). CUSTOMER SHALL, PRIOR TO USING OR DISTRIBUTING ANY SYSTEMS THAT INCORPORATE PRODUCTS, THOROUGHLY TEST SUCH SYSTEMS FOR SAFETY PURPOSES. USE OF PRODUCTS IN A SAFETY APPLICATION WITHOUT A SAFETY DESIGN IS FULLY AT THE RISK OF CUSTOMER, SUBJECT ONLY TO APPLICABLE LAWS AND REGULATIONS GOVERNING LIMITATIONS ON PRODUCT LIABILITY.

© Copyright 2012-2019 Xilinx, Inc. Xilinx, the Xilinx logo, Artix, ISE, Kintex, Spartan, UltraScale, Virtex, Vivado, Zynq, and other designated brands included herein are trademarks of Xilinx in the United States and other countries. All other trademarks are the property of their respective owners.