

LogiCORE IP I/O Module v1.02a

Product Guide

PG052 October 16, 2012

Table of Contents

SECTION I: SUMMARY

IP Facts

Chapter 1: Overview

Feature Summary	7
Licensing and Ordering Information	8

Chapter 2: Product Specification

Standards	9
Performance	9
Resource Utilization	10
Port Descriptions	11
Register Space	13

Chapter 3: Designing with the Core

General Design Guidelines	23
LMB Timing	28
Clocking	28
Resets	28
Protocol Description	29

SECTION II: VIVADO DESIGN SUITE

Chapter 4: Customizing and Generating the Core

GUI	31
Parameter Values	37

Chapter 5: Constraining the Core

Required Constraints	40
Device, Package, and Speed Grade Selections	40

Clock Frequencies	40
Clock Management	40
Clock Placement	40
Banking	41
Transceiver Placement	41
I/O Standard and Placement	41

SECTION III: ISE DESIGN SUITE

Chapter 6: Customizing and Generating the Core

GUI	43
Parameter Values	49

Chapter 7: Constraining the Core

Clock Management	51
------------------------	----

SECTION IV: APPENDICES

Appendix A: Migrating

Appendix B: Debugging

Solution Centers	54
------------------------	----

Appendix C: Application Software Development

Device Drivers	55
----------------------	----

Appendix D: Additional Resources

Xilinx Resources	56
References	56
Technical Support	56
Revision History	57
Notice of Disclaimer	57

SECTION I: SUMMARY

IP Facts

Overview

Product Specification

Designing with the Core

Introduction

The LogiCORE™ I/O Module is a highly integrated and light-weight implementation of a standard set of peripherals.

The I/O Module is a standalone version of the tightly coupled I/O Module included in the LogiCORE MicroBlaze™ Micro Controller System (MCS). Using the I/O Module, a system equivalent to MicroBlaze MCS can be design using the ISE® Design Suite Embedded Edition or the Vivado™ Design Suite.

The I/O Module connects to MicroBlaze through the lmb_v10 bus.

Features

- LMB v1.0 bus interfaces to communicate with MicroBlaze
- I/O Bus
- Interrupt Controller with fast interrupt mode support
- UART
- Fixed Interval Timers
- Programmable Interval Timers
- General Purpose Inputs
- General Purpose Outputs

LogiCORE IP Facts Table	
Core Specifics	
Supported Device Family ⁽¹⁾	Zynq™-7000 ⁽²⁾ , Virtex-7, Kintex™-7, Artix™-7, Virtex-6, Spartan-6, Virtex-5, Virtex®-4, Spartan®-3
Supported User Interfaces	Local Memory Bus (LMB), Dynamic Reconfiguration Port (DRP)
Resources	See Table 2-2 .
Provided with Core	
Design Files	ISE: VHDL Vivado: RTL
Example Design	Not Provided
Test Bench	Not Provided
Constraints File	Not Provided
Simulation Model	VHDL Behavioral
Supported S/W Driver ⁽³⁾	Standalone
Tested Design Flows	
Design Entry	Xilinx Platform Studio (XPS)
Simulation	Mentor Graphics ModelSim
Synthesis	Xilinx Synthesis Technology (XST) Vivado Synthesis ⁽⁵⁾
Support	
Provided by Xilinx @ www.xilinx.com/support	

Notes:

1. For a complete list of supported derivative devices, see the [Embedded Edition Derivative Device Support](#).
2. Supported in ISE Design Suite implementations only.
3. Standalone driver details can be found in the EDK or SDK directory (<install_directory>/doc/usenglish/xilinx_drivers.htm). Linux OS and driver support information is available from [//wiki.xilinx.com](http://wiki.xilinx.com).
4. For the supported versions of the tools, see the [Xilinx Design Tools: Release Notes Guide](#).
5. Supports only 7 series devices.

Overview

The I/O Module is a light-weight implementation of a set of standard I/O functions commonly used in a MicroBlaze™ processor sub-system. The input/output signals of the I/O Module are shown in Figure 1-1. The detailed list of signals are listed and described in Table 2-3. See the description of LMB Signals in the MicroBlaze Bus Interfaces chapter in the *MicroBlaze Processor Reference Guide* [Ref 1].

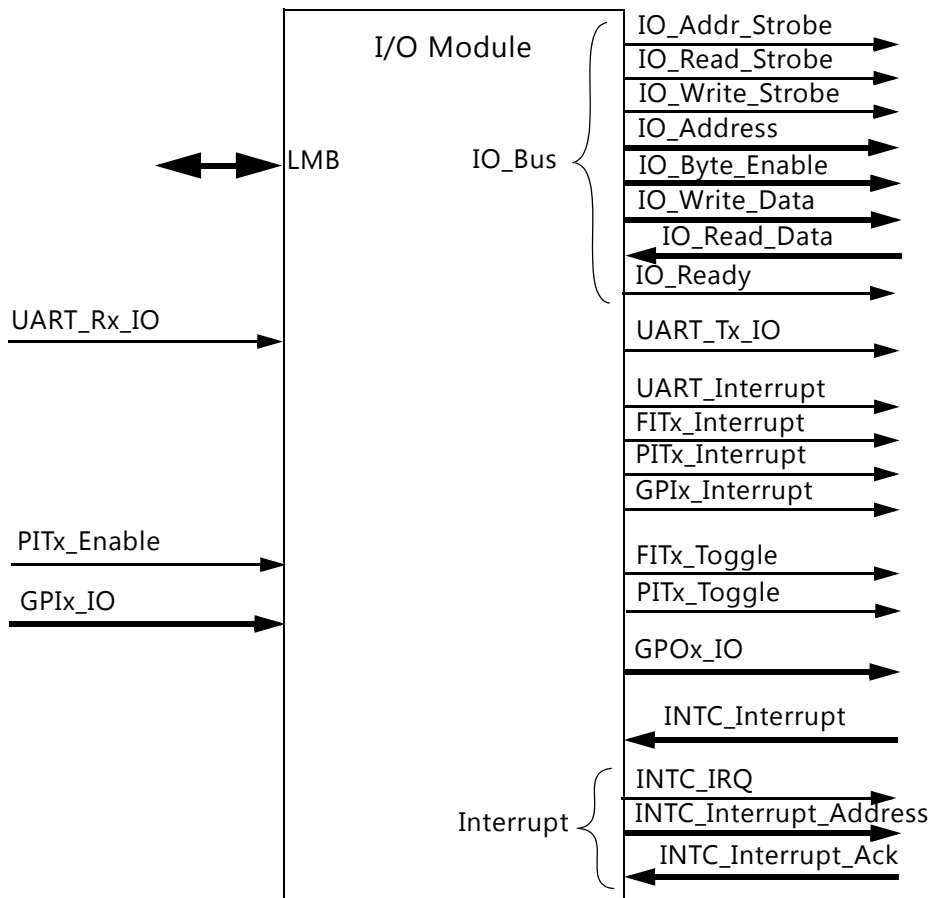

Figure 1-1: I/O Module Block Diagram

In a MicroBlaze system the I/O Module would typically be connected according to Figure 1-2.

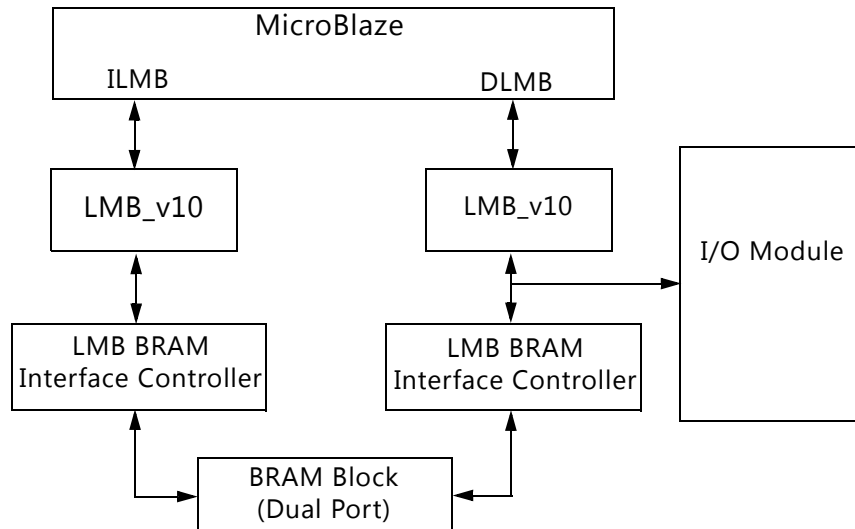

Figure 1-2: Typical MicroBlaze System

Feature Summary

I/O Bus

The I/O Bus provides a simple bus for accessing external modules. The I/O Bus is mapped in the MicroBlaze memory space, with the I/O Bus address directly reflecting the byte address used by MicroBlaze Load/Store instructions. I/O Bus data is 32-bit wide, with byte enables to write byte and half-word data.

The I/O Bus is fully compatible with the Xilinx Dynamic Reconfiguration Port (DRP).

UART

The Universal Asynchronous Receiver Transmitter (UART) interface provides the controller interface for asynchronous serial data transfers. Features supported include:

- One transmit and one receive channel (full duplex)
- Configurable number of data bits in a character (5-8)
- Configurable parity bit (odd or even)
- Configurable and programmable baud rate

Fixed Interval Timer, FIT

The Fixed Interval Timer generates a strobe signal at fixed intervals. The Fixed Interval Timer asserts the output signal and generates an interrupt according to the selected parameter values.

Programmable Interval Timer, PIT

The Programmable Interval Timer, PIT, has a configurable width from 1 to 32. The PIT operation and period are controlled by software. An interrupt can be generated when the timer lapses.

General Purpose Output, GPO

The General Purpose Output, GPO, drives I/O Module GPO output signals defined by the value of the corresponding GPO register, programmable from software. The width and initial value are defined by parameters.

General Purpose Input, GPI

The General Purpose Input, GPI, makes it possible for software to sample the value of the I/O Module GPI input signals by reading the GPI register. The width and whether to generate an interrupt are defined by parameters.

Interrupt Controller INTC

The Interrupt Controller handles both I/O module internal interrupt events and external ones. The internal interrupt events originate from the UART, the Fixed Interval Timers, the Programmable Interval Timers, or the General Purpose Inputs.

Licensing and Ordering Information

This Xilinx LogiCORE IP module is provided at no additional cost with the Xilinx Vivado Design Suite and ISE Design Suite Embedded Edition tools under the terms of the [Xilinx End User License](#).

Information about this and other Xilinx LogiCORE IP modules is available at the [Xilinx Intellectual Property](#) page. For information on pricing and availability of other Xilinx LogiCORE IP modules and tools, contact your [local Xilinx sales representative](#).

Product Specification

Standards

The I/O Bus interface provided by the I/O Module is fully compatible with the Xilinx Dynamic Reconfiguration Port (DRP). For a detailed description of the DRP, see the *7 Series FPGAs Configuration User Guide* [Ref 2].

Performance

The frequency and latency of the I/O Module are optimized for use together with MicroBlaze™. This means that the frequency targets are aligned to MicroBlaze targets as well as the access latency optimized for MicroBlaze data access.

Maximum Frequencies

The following are clock frequencies for the target families. The maximum achievable clock frequency can vary. The maximum achievable clock frequency and all resource counts can be affected by the used tool flow, other tool options, additional logic in the FPGA, using different versions of Xilinx tools, and other factors.

Table 2-1: Maximum Frequencies

Architecture	Speed grade	Max Frequency
Virtex-7	-3	320
Kintex™-7	-3	320
Artix™-7	-3	225
Virtex®-6	-3	300
Spartan®-6	-4	195

Latency

Data read from I/O Module registers is available two clock cycles after the address strobe is asserted.

Data write to I/O Module registers is performed the clock cycle after the address strobe is asserted.

Data accesses to peripherals connected on the I/O Bus take three clock cycles plus the number of wait states introduced by the accessed peripheral.

Throughput

The maximum throughput when using the I/O Bus is one read or write access every three clock cycles.

Resource Utilization

Because the MicroBlaze MCS is a module that is used together with other parts of the design in the FPGA, the utilization and timing numbers reported in this section are just estimates, and the actual utilization of FPGA resources and timing of the MicroBlaze MCS design will vary from the results reported here. All parameters not given in the table below have their default values.

Table 2-2: Performance and Resource Utilization Benchmarks on Virtex-6 (xc6vlx240t-1-ff1156)

Parameter Values (other parameters at default value)														Device Resources	
C_USE_UART_RX	C_USE_UART_TX	C_INTC_USE_EXT_INTR	C_INTC_INTR_SIZE	C_USE_FIT1	C_FIT1_No_CLOCKS	C_USE_PIT1	C_PIT1_SIZE	C_USE_GPI1	C_GPI1_SIZE	C_USE_GPO1	C_GPO1_SIZE	C_USE_IO_BUS	C_INTC_HAS_FAST	LUTs	Flip-Flops
1	1	0	0	0	0	0	0	0	0	0	0	0	0	40	75
1	1	1	5	0	0	0	0	0	0	0	0	0	0	69	110
1	1	1	5	0	0	0	0	0	0	0	0	0	1	118	173
1	1	1	5	1	65000	0	0	0	0	0	0	0	0	75	122
1	1	1	5	1	65000	1	32	0	0	0	0	0	0	121	216
1	1	1	5	1	65000	1	32	1	32	1	32	0	0	121	280
1	1	1	5	1	65000	1	32	1	32	1	32	1	0	119	361

Port Descriptions

The I/O ports and signals for the I/O Module are listed and described in [Table 2-3](#).

Table 2-3: I/O Module I/O Signals

Port Name	MSB:LSB	I/O	Description
LMB Signals			
LMB_ABus	0:C_LMB_AWIDTH-1	I	LMB Address Bus
LMB_WriteDBus	0:C_LMB_DWIDTH-1	I	LMB Write Data Bus
LMB_ReadStrobe		I	LMB Read Strobe
LMB_AddrStrobe		I	LMB Address Strobe
LMB_WriteStrobe		I	LMB Write Strobe
LMB_BE	0:C_LMB_DWIDTH/8-1	I	LMB Byte Enable Bus
SI_DBus	0:C_LMB_DWIDTH-1	O	LMB Read Data Bus
SI_Ready		O	LMB Data Ready
SI_Wait		O	LMB Wait
SI_CE		O	LMB Correctable Error
SI_UE		O	LMB Uncorrectable Error
I/O Bus Signals			
IO_Addr_Strobe		O	Address strobe signals valid I/O Bus output signals
IO_Read_Strobe		O	I/O Bus access is a read
IO_Write_Strobe		O	I/O Bus access is a write
IO_Address	31:0	O	Address for access
IO_Byte_Enable	3:0	O	Byte enables for access
IO_Write_Data	31:0	O	Data to write for I/O Bus write access
IO_Read_Data	31:0	I	Read data for I/O Bus read access
IO_Ready		I	Ready handshake to end I/O Bus access
UART Signals			
UART_Rx_IO		I	Receive Data
UART_Tx_IO		O	Transmit Data
UART_Interrupt		O	UART Interrupt
FIT Signals			
FITx_Interrupt ⁽¹⁾		O	FITx timer lapsed
FITx_Toggle ⁽¹⁾		O	Inverted FITx_Toggle when FITx timer lapses
PIT Signals			

Table 2-3: I/O Module I/O Signals (Cont'd)

Port Name	MSB:LSB	I/O	Description
PITx_Enable ⁽¹⁾		I	PITx count enable when C_PITx_PRESCALER = External
PITx_Interrupt ⁽¹⁾		O	PITx timer lapsed
PITx_Toggle ⁽¹⁾		O	Inverted PITx_Toggle when PITx lapses
GPO Signals			
GPOx ⁽¹⁾	[C_GPOx_SIZE - 1]:0	O	GPOx Output
GPI Signals			
GPIx ⁽¹⁾	[C_GPIx_SIZE - 1]:0	I	GPIx Input
GPIx_Interrupt ⁽¹⁾	[C_GPIx_SIZE - 1]:0	O	GPIx input changed
INTC Signals			
INTC_Interrupt	0:[C_INTC_INTR_SIZE - 1]	I	External interrupt inputs
INTC_IRQ		O	Interrupt Output
INTC_Interrupt_Address	[C_INTC_ADDR_WIDTH-1]:0	O	Interrupt Address Output
INTC_Interrupt_Ack	1:0	I	Interrupt Acknowledge Input

1. x = 1, 2, 3 or 4

Parameter - Port Dependencies

The width of many of the I/O Module signals depends on design parameters. The dependencies between the design parameters and I/O signals are shown in Table 2-4.

Table 2-4: Parameter-Port Dependencies

Parameter Name	Ports (Port width depends on parameter)
C_INTC_INTR_SIZE	INTC_Interrupt
C_INTC_ADDR_WIDTH	INTC_Interrupt_Address
C_GPO1_SIZE	GPO1
C_GPO2_SIZE	GPO2
C_GPO3_SIZE	GPO3
C_GPO4_SIZE	GPO4
C_GPI1_SIZE	GPI1
C_GPI2_SIZE	GPI2
C_GPI3_SIZE	GPI3
C_GPI4_SIZE	GPI4

Register Space

Table 2-5: I/O Module Register Address Map

Base Address + Offset (hex)	Register	Access Type	Description
C_BASEADDR + 0x0	UART_RX	R	UART Receive Data Register
C_BASEADDR + 0x4	UART_TX	W	UART Transmit Data Register
C_BASEADDR + 0x8	UART_STATUS	R	UART Status Register
C_BASEADDR + 0xC	IRQ_MODE	W	Interrupt Mode Register
C_BASEADDR + 0x10	GPO1	W	General Purpose Output 1 Register
C_BASEADDR + 0x14	GPO2	W	General Purpose Output 2 Register
C_BASEADDR + 0x18	GPO3	W	General Purpose Output 3 Register
C_BASEADDR + 0x1C	GPO4	W	General Purpose Output 4 Register
C_BASEADDR + 0x20	GPI1	R	General Purpose Input 1 Register
C_BASEADDR + 0x24	GPI2	R	General Purpose Input 2 Register
C_BASEADDR + 0x28	GPI3	R	General Purpose Input 3 Register
C_BASEADDR + 0x2C	GPI4	R	General Purpose Input 4 Register
C_BASEADDR + 0x30	IRQ_STATUS	R	Interrupt Status Register
C_BASEADDR + 0x34	IRQ_PENDING	R	Pending Interrupt Register
C_BASEADDR + 0x38	IRQ_ENABLE	W	Interrupt Enable Register
C_BASEADDR + 0x3C	IRQ_ACK	W	Interrupt Acknowledge Register
C_BASEADDR + 0x40	PIT1_PRELOAD	W	PIT1 Preload Register
C_BASEADDR + 0x44	PIT1_COUNTER	R	PIT1 Counter Register
C_BASEADDR + 0x48	PIT1_CONTROL	W	PIT1 Control Register
C_BASEADDR + 0x4C	UART_BAUD	W	UART Programmable Baud Rate
C_BASEADDR + 0x50	PIT2_PRELOAD	W	PIT2 Preload Register
C_BASEADDR + 0x54	PIT2_COUNTER	R	PIT2 Counter Register
C_BASEADDR + 0x58	PIT2_CONTROL	W	PIT2 Control Register
C_BASEADDR + 0x5C	Reserved		
C_BASEADDR + 0x60	PIT3_PRELOAD	W	PIT3 Preload Register
C_BASEADDR + 0x64	PIT3_COUNTER	R	PIT3 Counter Register
C_BASEADDR + 0x68	PIT3_CONTROL	W	PIT3 Control Register
C_BASEADDR + 0x6C	Reserved		
C_BASEADDR + 0x70	PIT4_PRELOAD	W	PIT4 Preload Register
C_BASEADDR + 0x74	PIT4_COUNTER	R	PIT4 Counter Register
C_BASEADDR + 0x78	PIT4_CONTROL	W	PIT4 Control Register
C_BASEADDR + 0x7C	Reserved		

Table 2-5: I/O Module Register Address Map (Cont'd)

Base Address + Offset (hex)	Register	Access Type	Description
C_BASEADDR + 0x80 - C_BASEADDR + 0xFC	IRQ_VECTOR_0 - IRQ_VECTOR_31	W	Interrupt Address Vector Registers
(C_BASEADDR + 0x100) - C_HIGHADDR	Reserved		
C_IO_BASEADDR - C_IO_HIGHADDR	I/O Bus	RW	Mapped to I/O Bus address output IO_Address

UART Receive Data Register (UART_RX)

This register contains data received by the UART. Reading this location results in reading the current word from the register. When a read request is issued without having received a new character, the previously read data is read again. This register is a read-only register. Issuing a write request to the register does nothing but generate the write acknowledgement. The register is implemented if C_USE_UART_RX is set to 1.

Table 2-6: UART Receive Data Register (UART_RX) (C_DATA_BITS=8)

Reserved		UART_RX	
31	8	7	0

Table 2-7: UART Receive Data Register Bit Definitions

Bit(s)	Name	Core Access	Reset Value	Description
31:C_UART_DATA_BITS	-	R	0	Reserved
[C_UART_DATA_BITS-1]:0	UART_RX	R	0	UART Receive Data

UART Transmit Data Register (UART_TX)

A register contains data to be output by the UART. Data to be transmitted is written into this register. This is write only location. Issuing a read request to this register generates the read acknowledgement with zero data. Writing this register when the character has not been transmitted will overwrite previously written data, resulting in loss of data. The register is implemented if C_USE_UART_TX is set to 1.

Table 2-8: UART Transmit Data Register (UART_TX) (C_DATA_BITS=8)

Reserved		UART_TX	
31	8	7	0

Table 2-9: UART Transmit Data Register Bit Definitions

Bit(s)	Name	Core Access	Reset Value	Description
31:C_UART_DATA_BITS	-	R	0	Reserved
[C_UART_DATA_BITS-1]:0	UART_TX	R	0	UART Transmit Data

UART Status Register (UART_Status)

The UART Status Register contains the status of the receive and transmit registers, and if there are any errors. This is read only register. If a write request is issued to status register it will do nothing but generate write acknowledgement. The register is implemented if C_USE_UART_RX or C_USE_UART_TX is set to 1.

Table 2-10: UART Status Register (UART_Status)

Reserved		UART_Status	
31	8	7	0

Table 2-11: UART Status Register Bit Definitions

Bit(s)	Name	Core Access	Reset Value	Description
7	Parity Error	R	0	Indicates that a parity error has occurred after the last time the status register was read. If the UART is configured without any parity handling, this bit is always '0'. The received character is written into the receive register. This bit is cleared when the status register is read. 0 = No parity error has occurred 1 = A parity error has occurred
6	Frame Error	R	0	Indicates that a frame error has occurred after the last time the status register was read. Frame Error is defined as detection of a stop bit with the value 0. The receive character is ignored and not written to the receive register. This bit is cleared when the status register is read. 0 = No Frame error has occurred 1 = A frame error has occurred
5	Overrun Error	R	0	Indicates that an overrun error has occurred since the last time the status register was read. Overrun occurs when a new character has been received but the receive register has not been read. The received character is ignored and not written into the receive register. This bit is cleared when the status register is read. 0 = No interrupt has occurred 1 = Interrupt has occurred
4	-	R	0	Reserved
3	Tx Used	R	0	Indicates if the transmit register is in use 0 = Transmit register is not in use 1 = Transmit register is in use
2	-	R	0	Reserved
1	-	R	0	Reserved
0	Rx Valid Data	R	0	Indicates if the receive register has valid data 0 = Receive register is empty 1 = Receive register has valid data

UART Programmable Baud Rate Register (UART_BAUD)

This register sets the baud rate when using programmable baud rate. The initial value of the register is determined from the selected fixed baud rate C_UART_BAUDRATE and the clock frequency C_FREQ, using the formula:

$$\text{UART_BAUD} = \frac{\text{C_FREQ}}{\text{C_UART_BAUDRATE} \cdot 16} - 1$$

Table 2-12: UART Programmable Baud Rate Register (UART_BAUD)

Reserved		UART_BAUD	
31	20	19	0

Table 2-13: UART Programmable Baud Rate Register Bit Definitions

Bit(s)	Name	Core Access	Reset Value	Description
31:20	-	-	-	Reserved
19:0	UART_BAUD	W	See above	Programmed UART Baud Rate

General Purpose Output x Register (GPOx) (x = 1, 2, 3 or 4)

This register holds the value that will be driven to the corresponding bits in the I/O Module GPOx port output signals. All bits in the register are updated when the register is written. This register is not implemented if the value of C_USE_GPOx is 0.

Table 2-14: General Purpose Output x Register (GPOx)

Reserved		GPOx	
31	C_GPOx_SIZE	C_GPOx_SIZE-1	0

Table 2-15: General Purpose Output x Register Bit Definitions

Bit(s)	Name	Core Access	Reset Value	Description
31:C_GPOx_SIZE	-	-	-	Reserved
[C_GPOx_SIZE-1]:0	GPOx	W	0	Register holds data driven to corresponding bits in the GPO port

General Purpose Input x Register (GPIx) (x=1, 2, 3 or 4)

This register reads the value that is input on the corresponding I/O Module GPIx port input signal bits. This register is not implemented if the value of C_USE_GPIx is 0.

Table 2-16: General Purpose Input x Register (GPIx)

Reserved		GPIx	
31	C_GPIx_SIZE	C_GPIx_SIZE-1	0

Table 2-17: General Purpose Input x Register Bit Definitions

Bit(s)	Name	Core Access	Reset Value	Description
31:C_GPIx_SIZE	-	R	0	Reserved
[C_GPIx_SIZE-1]:0	GPIx	R	0	Register reads value input on the I/O Module GPIx port input signals

Interrupt Status Register (IRQ_STATUS)

The Interrupt Status Register holds information on interrupt events that have occurred. The register is read-only and the IRQ_ACK register should be used to clear individual interrupts.

Table 2-18: Interrupt Status Register (IRQ_STATUS)

Reserved		INTC_Interrupt		Reserved		Internal Interrupts	
31	C_INTC_EXT_INTR+16	C_INTC_EXT_INTR+15	16	15	11	10	0

Table 2-19: Interrupt Status Register Bit Definitions

Bit(s)	Name	Core Access	Reset Value	Description
31:[C_INTC_EXT_INTR + 16]	-	R	0	Reserved
[C_INTC_EXT_INTR+15]:16	INTC_Interrupt	R	0	I/O Module external interrupt input signal INTC_Interrupt [C_INTC_EXT_INTR-1:0] mapped to corresponding bit positions in IRQ_STATUS
15	-	R	0	Reserved
14	GPI4	R	0	GPI4 changed
13	GPI3	R	0	GPI3 changed
12	GPI2	R	0	GPI2 changed
11	GPI1	R	0	GPI1 changed
10	FIT4	R	0	FIT4 strobe
9	FIT3	R	0	FIT3 strobe
8	FIT2	R	0	FIT2 strobe
7	FIT1	R	0	FIT1 strobe
6	PIT4	R	0	PIT4 lapsed
5	PIT3	R	0	PIT3 lapsed
4	PIT2	R	0	PIT2 lapsed
3	PIT1	R	0	PIT1 lapsed
2	UART_RX	R	0	UART Received Data
1	UART_TX	R	0	UART Transmitted Data
0	UART_ERR	R	0	UART Error

Interrupt Pending Register (IRQ_PENDING)

The Interrupt Pending Register holds information on enabled interrupt events that have occurred. IRQ_PENDING is the contents of IRQ_STATUS bit-wised masked with the IRQ_ENABLE register. The register is read-only and the IRQ_ACK register should be used to clear individual interrupts.

Table 2-20: Interrupt Pending Register (IRQ_PENDING)

Reserved		INTC_Interrupt		Reserved		Internal Interrupts	
31	C_INTC_EXT_INTR+16	C_INTC_EXT_INTR+15	16	15	11	10	0

Table 2-21: Interrupt Pending Register Bit Definitions

Bit(s)	Name	Core Access	Reset Value	Description
31:[C_INTC_EXT_INTR+16]	-	R	0	Reserved
[C_INTC_EXT_INTR+15]:16	INTC_Interrupt	R	0	I/O Module external interrupt input signal INTC_Interrupt [C_INTC_EXT_INTR-1:0] mapped to corresponding bit positions in IRQ_STATUS
15	-	R	0	Reserved
14	GPI4	R	0	GPI4 changed
13	GPI3	R	0	GPI3 changed
12	GPI2	R	0	GPI2 changed
11	GPI1	R	0	GPI1 changed
10	FIT4	R	0	FIT4 strobe
9	FIT3	R	0	FIT3 strobe
8	FIT2	R	0	FIT2 strobe
7	FIT1	R	0	FIT1 strobe
6	PIT4	R	0	PIT4 lapsed
5	PIT3	R	0	PIT3 lapsed
4	PIT2	R	0	PIT2 lapsed
3	PIT1	R	0	PIT1 lapsed
2	UART_RX	R	0	UART Received Data
1	UART_TX	R	0	UART Transmitted Data
0	UART_ERR	R	0	UART Error

Interrupt Enable Register (IRQ_ENABLE)

The Interrupt Enable Register enables assertion of the I/O Module interrupt output signal INTC_IRQ by individual interrupt sources. The contents of this register are also used to mask the value of the IRQ_STATUS register when registering enabled interrupts in the IRQ_PENDING register.

Table 2-22: Interrupt Enable Register (IRQ_ENABLE)

Reserved		INTC_Interrupt		Reserved		Internal Interrupts	
31	C_INTC_EXT_INTR+16	C_INTC_EXT_INTR+15	16	15	11	10	0

Table 2-23: Interrupt Enable Register Bit Definitions

Bit(s)	Name	Core Access	Reset Value	Description
31:[C_INTC_EXT_INTR+16]	-	-	0	Reserved
[C_INTC_EXT_INTR+15]:16	INTC_Interrupt	W	0	Enable I/O Module external interrupt input signal INTC_Interrupt(16-C_INTC_EXT_INTR)
15	-	-	0	Reserved
14	GPI4	R	0	GPI4 changed
13	GPI3	R	0	GPI3 changed
12	GPI2	R	0	GPI2 changed
11	GPI1	R	0	GPI1 changed
10	FIT4	W	0	FIT4 interrupt enabled
9	FIT3	W	0	FIT3 interrupt enabled
8	FIT2	W	0	FIT2 interrupt enabled
7	FIT1	W	0	FIT1 interrupt enabled
6	PIT4	W	0	PIT4 interrupt enabled
5	PIT3	W	0	PIT3 interrupt enabled
4	PIT2	W	0	PIT2 interrupt enabled
3	PIT1	W	0	PIT1 interrupt enabled
2	UART_RX	W	0	UART Received Data interrupt enabled
1	UART_TX	W	0	UART Transmitted Data interrupt enabled
0	UART_ERR	W	0	UART Error interrupt enabled

Interrupt Acknowledge Register (IRQ_ACK)

This register is used as a command register for clearing individual interrupts in IRQ_STATUS and IRQ_PENDING registers. All bits set to 1 clear the corresponding bits in the IRQ_STATUS and IRQ_PENDING registers. The register is write-only.

Table 2-24: Interrupt Acknowledge Register (IRQ_ACK)

IRQ_ACK	
31	0

Table 2-25: Interrupt Acknowledge Register Bit Definitions

Bit(s)	Name	Core Access	Reset Value	Description
31:0	IRQ_ACK	W	0	All bit position written with 1 will clear corresponding bits in both the IRQ_STATUS and the IRQ_PENDING registers

Interrupt Mode Register (IRQ_MODE)

This register is used to define which interrupts use fast interrupt mode. All bits set to 1 use fast interrupt mode. The register is write-only. The register is only implemented when fast interrupt mode is enabled, by setting C_INTC_HAS_FAST to 1.

Table 2-26: Interrupt Mode Register (IRQ_MODE)

IRQ_MODE	
31	0

Table 2-27: Interrupt Mode Register Bit Definitions

Bit(s)	Name	Core Access	Reset Value	Description
31:0	IRQ_MODE	W	0	All bit positions written with 1 use fast interrupt mode

Interrupt Address Vector Registers (IRQ_VECTOR_0 - IRQ_VECTOR_31)

These 32 registers are used as Interrupt Address Vector for the corresponding interrupt bit. The content is sent to the processor on the INTC_Interrupt_Address port when the interrupt occurs. The registers are write-only.

The two least significant bits and the most significant bits greater than or equal to C_INTC_ADDR_WIDTH (if any) of each register are fixed to 0.

For reserved interrupt bits (11-15), and unused external interrupts (greater than C_INTC_EXT_INTR+15), writing to the corresponding register has no effect.

The registers are only implemented when fast interrupt mode is enabled, by setting C_INTC_HAS_FAST to 1.

Table 2-28: Interrupt Address Vector Register (IRQ_VECTOR_x)

0		IRQ_VECTOR_x	0
31	C_INTC_ADDR_WIDTH	C_INTC_ADDR_WIDTH-1	2 1 0

Table 2-29: Interrupt Address Vector Register Bit Definitions

Bit(s)	Name	Core Access	Reset Value	Description
31:0	IRQ_VECTOR	W	(1)	The Interrupt Address Vector for the corresponding interrupt.

1. C_INTC_BASE_VECTORS + 0x10

PITx Preload Register (PITx_PRELOAD) (x = 1, 2, 3 or 4)

The value written to this register determines the period between two consecutive PITx_Interrupt events. The period is the value written to the register + 2 count events. The register is implemented if C_USE_PITx is 1.

Table 2-30: PITx Preload Register (PITx_PRELOAD)

	Reserved	PITx_PRELOAD
31	C_PITx_SIZE	C_PITx_SIZE-1 0

Table 2-31: PITx Preload Register Bit Definitions

Bit(s)	Name	Core Access	Reset Value	Description
31:C_PITx_SIZE	-	-	-	Reserved
[C_PITx_SIZE-1]:0	PITx_PRELOAD	W	0	Register holds the timer period

PITx Counter Register (PITx_COUNTER) (x = 1, 2, 3 or 4)

When reading this register the data obtained is a sample of the current counter value. The register is implemented if C_USE_PITx is 1 and C_PITx_READABLE is 1.

Table 2-32: PITx Counter Register (PITx_COUNTER)

Reserved		PITx_PRELOAD	
31	C_PITx_SIZE	C_PITx_SIZE-1	31

Table 2-33: PITx Counter Register Bit Definitions

Bit(s)	Name	Core Access	Reset Value	Description
31:C_PITx_SIZE	-	-	-	Reserved
[C_PITx_SIZE-1]:0	PITx_COUNTER	R	0	PITx counter value at time of read

PITx Control Register (PITx_CONTROL) (x=1, 2, 3 or 4)

The EN bit in this register enables/disables counting. The PRELOAD bit determines if the counting is continuous with automatic reload of the PITx_PRELOAD value when lapsing (PITx_COUNTER = 0) or if the counting is stopped after counting the number of cycles defined in PITx_PRELOAD. The register is implemented if C_USE_PITx is 1.

Table 2-34: PITx Control Register (PITx_CONTROL)

Reserved		RELOAD	EN
31	2	1	0

Table 2-35: PITx Control Register Bit Definitions

Bit(s)	Name	Core Access	Reset Value	Description
31:2	-	-	0	Reserved
1	PRELOAD	W	0	0 = Counter counts PITx_PRELOAD value cycles and the stops 1 = Counter value is automatically reloaded with the PITx_PRELOAD value when counter lapses
0	EN	W	0	0 = Counting Disabled 1 = Counter Enabled

Designing with the Core

This chapter includes guidelines and additional information to facilitate designing with the core.

General Design Guidelines

I/O Bus

The I/O Bus provides a simple bus for accessing to external modules using MicroBlaze™ Load/Store instructions. The I/O Bus is mapped at address `C_IO_BASEADDR–C_IO_HIGHADDR` in the MicroBlaze memory space, with the I/O Bus address directly reflecting the byte address used by MicroBlaze Load/Store instructions. I/O Bus data is 32-bit wide, with byte enables to write byte and half-word data.

The I/O Bus has a ready handshake to handle different waitstate needs, from `IO_Ready` asserted the cycle after the `IO_Addr_Strobe` is asserted to as many cycles as needed. There is no timeout on the I/O Bus and MicroBlaze is stalled until `IO_Ready` is asserted. `IO_Address`, `IO_Byte_Enable`, `IO_Write_Data`, `IO_Read_Strobe`, `IO_Write_Strobe` are only valid when `IO_Addr_Strobe` is asserted. For read access `IO_Read_Data` is sampled at the rising `Clk` edge, when the slave has asserted `IO_Ready`.

I/O Bus read and write transactions can be found in the two following timing diagrams in [Figure 3-1](#) and [Figure 3-2](#).

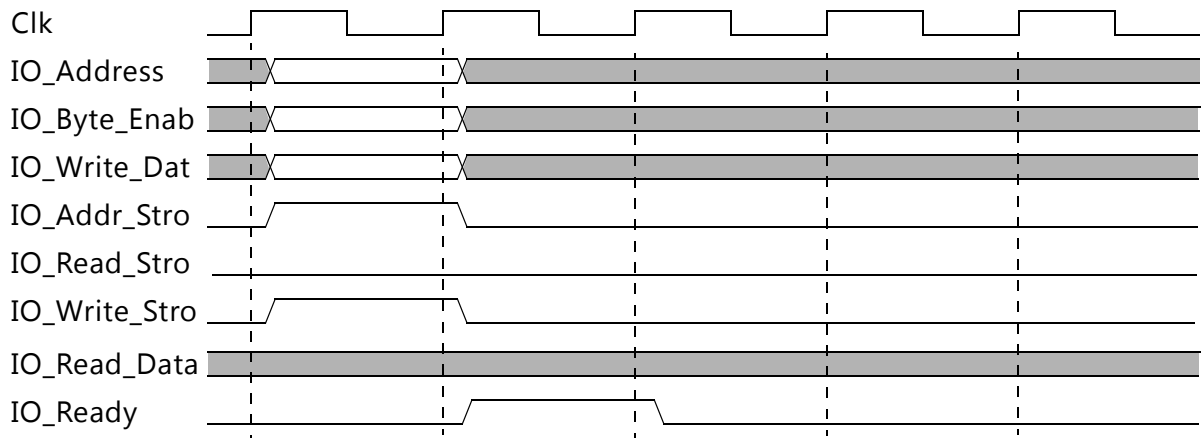

Figure 3-1: I/O Bus Write

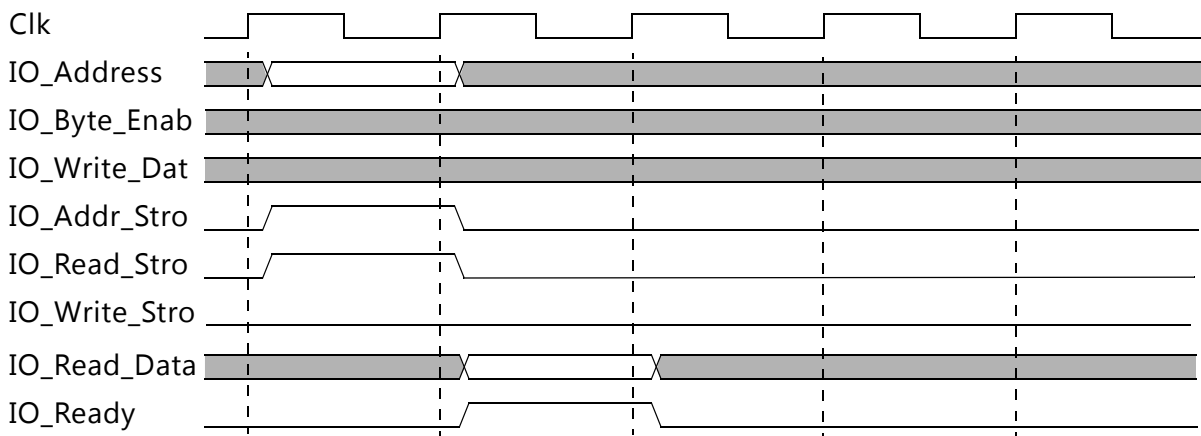

Figure 3-2: I/O Bus Read

The byte enable signals indicate which byte lanes of the data bus contain valid data. Valid values for `IO_Byte_Enable` are shown in [Table 3-1](#). The `IO_Byte_Enable` signal should be used instead of the two least significant bits of the `IO_Address` to decode byte and halfword accesses, to ensure that byte and halfword accesses are correctly decoded independent of MicroBlaze endianness.

Table 3-1: Valid Values for `IO_Byte_Enable[3:0]`

IO_Byte_Enable	IO_Data_Write and IO_Data_Read Byte Lanes Used				
	[3:0]	[31:24]	[23:16]	[15:8]	[7:0]
0001					
0010					
0100					
1000					
0011					
1100					
1111					

The I/O Bus is fully compatible with the Xilinx Dynamic Reconfiguration Port (DRP). This configuration port supports partial dynamic reconfiguration of functional blocks, such as CMTs, clock management, XADC, serial transceivers, and the PCIe® block.

The nominal connection of the I/O Bus to the DRP is shown in [Table 3-2](#).

Table 3-2: Mapping of the I/O Bus to the Dynamic Reconfiguration Port

MicroBlaze MCS Signal	DRP Signal	Note
Clk	DCLK	
IO_Addr_Strobe	DEN	
IO_Read_Strobe	-	Not used by DRP
IO_Write_Strobe	DWE	
IO_Address[m+2:2]	DADDR[m:0]	Uses 32-bit word access for DRP
IO_Byte_Enable	-	Only 32-bit word accesses used for DRP
IO_Write_Data[n:0]	DI[n:0]	Data width depends on DRP (n < 32)
IO_Read_Data[n:0]	DO[n:0]	Data width depends on DRP (n < 32)
IO_Ready	DRDY	

For a detailed description of the DRP, see the *7 Series FPGAs Configuration User Guide* [Ref 2].

UART

The Universal Asynchronous Receiver Transmitter (UART) interface provides the controller interface for asynchronous serial data transfers. Features supported include:

- One transmit and one receive channel (full duplex)
- Configurable number of data bits in a character (5-8)
- Configurable parity bit (odd or even)
- Configurable and programmable baud rate

The UART performs parallel-to-serial conversion on characters received through LMB and serial-to-parallel conversion on characters received from a serial peripheral. The UART is capable of transmitting and receiving 8, 7, 6 or 5-bit characters, with 1-stop bit and odd, even or no parity. The UART can transmit and receive independently.

The device can be configured and its status can be monitored via the internal register set. The UART also asserts the `UART_Interrupt` output when the receiver becomes non-empty, when the transmitter becomes empty or when an error condition has occurred. The individual interrupt events are connected to the Interrupt Controller of the I/O Module and can be used to assert the `INTC_IRQ` output signal.

The UART can be configured with either fixed or programmable baud rate. When using programmable baud rate the UART_BAUD register is used to set the baud rate. The initial value of this register is determined from the selected fixed baud rate. The register value is calculated by the formula:

$$\text{UART_BAUD} = \frac{\text{Clock Frequency of Clk (Hz)}}{\text{Baud Rate} \bullet 16} - 1$$

Fixed Interval Timer, FIT

The Fixed Interval Timer generates a strobe (interrupt) signal at fixed intervals. The Fixed Interval Timer asserts the output signal `FITx_Interrupt` one clock cycle every `C_FITx_NO_CLOCKS`. Operation begins immediately after FPGA configuration and the clock is running. The `FITx_Toggle` output signal is toggled each time `FITx_Interrupt` is asserted, creating a 50% duty cycle output with twice the `FITx_Interrupt` period. Using the parameter `C_FITx_INTERRUPT`, the FIT can be connected to the Interrupt Controller of the I/O Module and used for generating interrupts every time the strobe occurs.

Programmable Interval Timer, PIT

The Programmable Interval Timer, PIT, has a configurable width from 1 to 32. The PIT operation and period are controlled by software.

The `PITx_Interrupt` output signal is asserted one clock cycle when the timer lapses. The timer can be used in continuous mode, where the timer reloads automatically when it lapses. In continuous mode, the period between two `PITx_Interrupt` assertions is the value in PITx Preload Register + 2 count events.

The PIT can also be used in one-shot mode, where the timer stops when it has reached zero. The timer is implemented by means of a counter that is pre-loaded with the timer value and then decremented. When the counter reaches zero, the timer lapses, and the interrupt signal is generated. The timer starts counting when it is enabled by setting the EN bit in the PITx Control Register.

The `PITx_Toggle` output signal is toggled each time `PITx_Interrupt` is asserted, creating a 50% duty cycle output with twice the `PITx_Interrupt` period when the timer is operated in continuous mode.

The value of the counter that implements the timer can be read by software if the `C_PITx_Readable` parameter is enabled. The PIT can have a pre-scaler connected from any FITx, PITx, or External. The pre-scaler is selected by the `C_PITx_PRESCALER` parameter. The PIT has no pre-scaler by default. If External is selected the input signal `PITx_Enable` is used as pre-scaler. Selecting External as pre-scaler can also be used to measure the width in clock cycles of a signal connected to the `PITx_Enable` input.

Using the parameter `C_PITx_INTERRUPT`, the PIT can be connected to the Interrupt Controller of the I/O Module and used for generating interrupts every time it lapses.

General Purpose Output, GPO

The General Purpose Output, GPO, drives I/O Module GPO output signals defined by the value of the GPOx register, programmable from software. The width of the GPOx is defined by the C_GPOx_SIZE and the initial value is defined by the parameter C_GPOx_INIT. When the GPOx register is written, the value of the GPOx output signals change accordingly.

General Purpose Input, GPI

The General Purpose Input, GPI, makes it possible for software to sample the value of the I/O Module GPI input signals by reading the GPIx register. The width of GPIx is defined by the parameter C_GPIx_SIZE.

Using the parameter C_GPIx_INTERRUPT, the GPI can be connected to the Interrupt Controller of the I/O Module and used for generating interrupts every time an input changes.

Interrupt Controller INTC

The Interrupt Controller handles both I/O module internal interrupt events and external ones. The internal interrupt events originate from the UART, the Fixed Interval Timers, the Programmable Interval Timers, or the General Purpose Inputs. For an internal interrupt to be generated on the INTC_IRQ output, the corresponding I/O Module parameter needs to be set, for example, C_UART_RX_INTERRUPT=1, and that particular interrupt needs to be enabled in the Interrupt Enable Register.

The Interrupt Controller supports up to 16 external interrupts using the INTC_Interrupt inputs. The number of external interrupts is defined by the parameter, C_INTC_INTR_SIZE. The external interrupt signals can be individually configured as either edge or level sensitive by the C_INTC_LEVEL_EDGE parameter. The polarity of the external interrupt signals can be individually configured to be either active-High (rising edge) or Low (falling edge) by the C_INTC_POSITIVE parameter. Interrupt events for external interrupt sources are generated according to [Table 3-3](#).

Table 3-3: Interrupt Event Generation

C_INTC_LEVEL_EDGE(x)	C_INTC_POSITIVE(x)	INTC_Interrupt(x) Input
0	0	0
0	1	1
1	0	1 -> 0
1	1	0 -> 1
0	0	0

The current status of all interrupt sources can be read from the Interrupt Status Register. The current status of all enabled interrupts can be read from the Interrupt Pending Register.

An interrupt is cleared in both the Interrupt Status and Interrupt Pending Registers by writing to the Interrupt Acknowledge Register, with bits set corresponding to the interrupts that should be cleared.

Either normal or fast interrupt mode can be used, based on latency requirement. Fast interrupt mode is available when the parameter `C_INTC_HAS_FAST` is set, and is enabled for an interrupt by setting the corresponding bit in the Interrupt Mode Register (`IRQ_MODE`). In this case, the Interrupt Controller drives the interrupt vector address of the highest priority interrupt on the `INTC_Interrupt_Address` port, along with `INTC_IRQ`. The generated interrupt is cleared based on acknowledge received from the processor through the `INTC_Interrupt_Ack` port. The processor sends `0b01` on this port when the interrupt is being acknowledged by the processor (that is, when branching to the interrupt service routine), sends `0b10` when executing a return from interrupt instruction in the interrupt service routine, and sends `0b11` when interrupts are re-enabled. The bit in `IRQ_STATUS` corresponding to the interrupt is cleared when `0b10` or `0b11` is seen on the port.

With fast interrupt mode, the interrupt vector address for each interrupt is stored in the corresponding `IRQ_VECTOR` register. To be compatible with normal mode, the registers are initialized to `C_INTC_BASE_VECTORS + 0x10` after reset, which is equivalent to the static interrupt vector used by normal mode.

LMB Timing

See the MicroBlaze Bus Interfaces chapter in the *MicroBlaze Processor Reference Guide* [Ref 1] for details on the transaction signaling.

Clocking

The I/O Module is fully synchronous with all clocked elements clocked with the `C1k` input.

Resets

The `Rst` input is the master reset input signal for the I/O Module.

Protocol Description

See LMB Interface Description timing diagrams in the *MicroBlaze Processor Reference Guide* [Ref 1].

SECTION II: VIVADO DESIGN SUITE

Customizing and Generating the Core

Constraining the Core

Customizing and Generating the Core

This chapter includes information on using Xilinx tools to customize and generate the core in the Vivado™ Design Suite.

GUI

The I/O Module parameters are divided in seven tabs: System, UART, FIT Timers, PIT Timers, GPO, GPI and Interrupt. When using Vivado IP Integrator, the addresses and masks are auto generated.

The System tab is shown in [Figure 4-1](#).

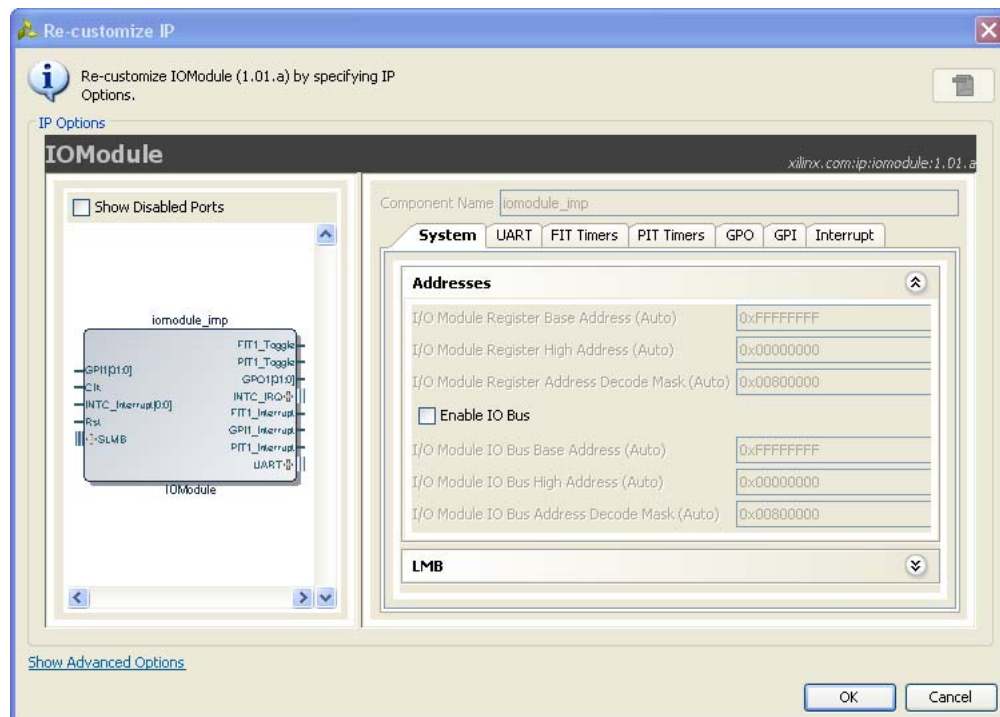

Figure 4-1: System Tab

- **I/O Module Register Base Address** - Base address of the internal registers.
- **I/O Module Register High Address** - High address of the internal registers.

- **I/O Module Register Address Decode Mask** - A mask indicating which address bits the module takes into account when decoding a register access.
- **Enable IO Bus** - Enables the I/O Bus to connect to DRP or external peripherals.
- **I/O Module IO Bus Base Address** - Base address of the I/O Bus.
- **I/O Module IO Bus High Address** - High address of the I/O Bus.
- **I/O Module IO Bus Address Decode Mask** - A mask indicating which address bits the module takes into account when decoding an I/O Bus access.

The UART parameter tab is shown in [Figure 4-2](#).

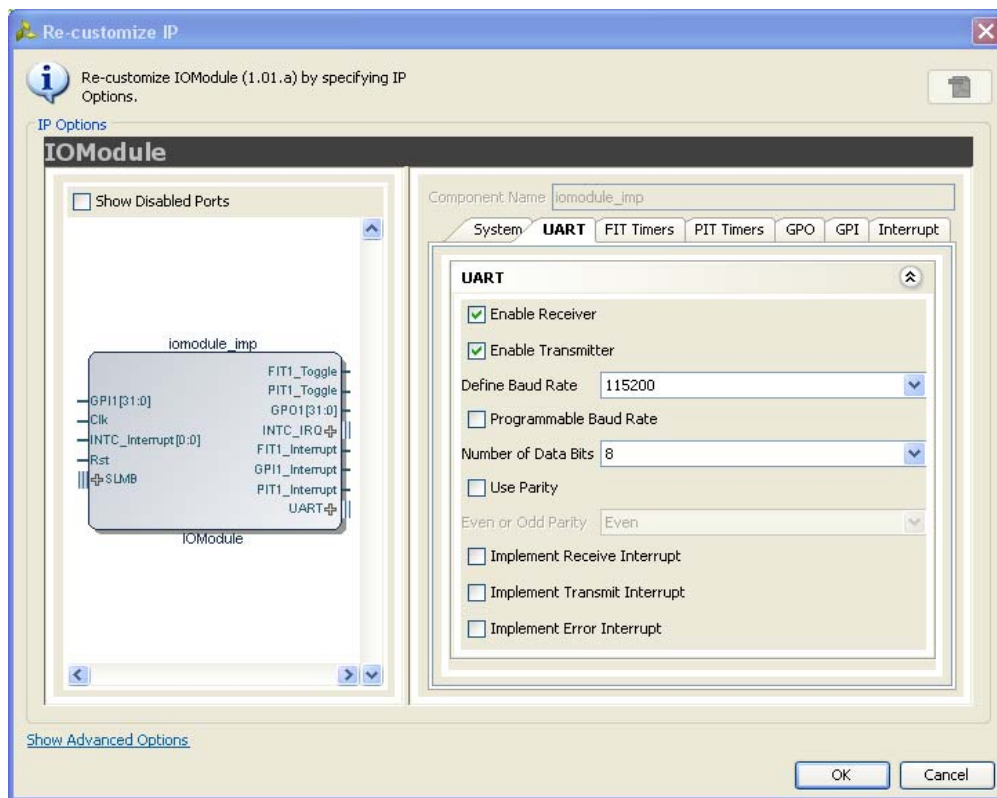

Figure 4-2: UART Parameter Tab

- **Enable Receiver** - Enables UART receiver for character input. This is automatically connected to standard input (`stdin`) in the software program.
- **Enable Transmitter** - Enables UART transmitter for character output. This is automatically connected to standard output (`stdout`) in the software program.
- **Define Baud Rate** - Sets the UART baud rate. To get the correct baud rate, the input clock frequency must also be correctly defined.
- **Programmable Baud Rate** - Determines if the UART baud rate is programmable. The default baud rate is calculated based on the input clock frequency and the defined baud rate.

- **Number of Data Bits** - Defines the number of data bits used by the UART. Should almost always be set to 8.
- **Use Parity** - Enable this parameter to use parity checking of the UART characters.
- **Even or Odd Parity** - Select odd or even parity. Only available when parity is used.
- **Implement Receive Interrupt** - Generate an interrupt when the UART has received a character. When the interrupt is not enabled the UART must be polled to check if data has been received.
- **Implement Transmit Interrupt** - Generate an interrupt when the UART has sent a character. When the interrupt is not enabled the UART must be polled to wait until data has been transmitted.
- **Implement Error Interrupt** - Generate an interrupt if an error occurs when the UART receives a character. This error can be a framing error, an overrun error or a parity error (if parity is used), When the interrupt is not enabled the UART must be polled to check if an error has occurred after a character has been received.

The FIT Timer parameter tab showing the parameters for one of the four timers is shown in Figure 4-3.

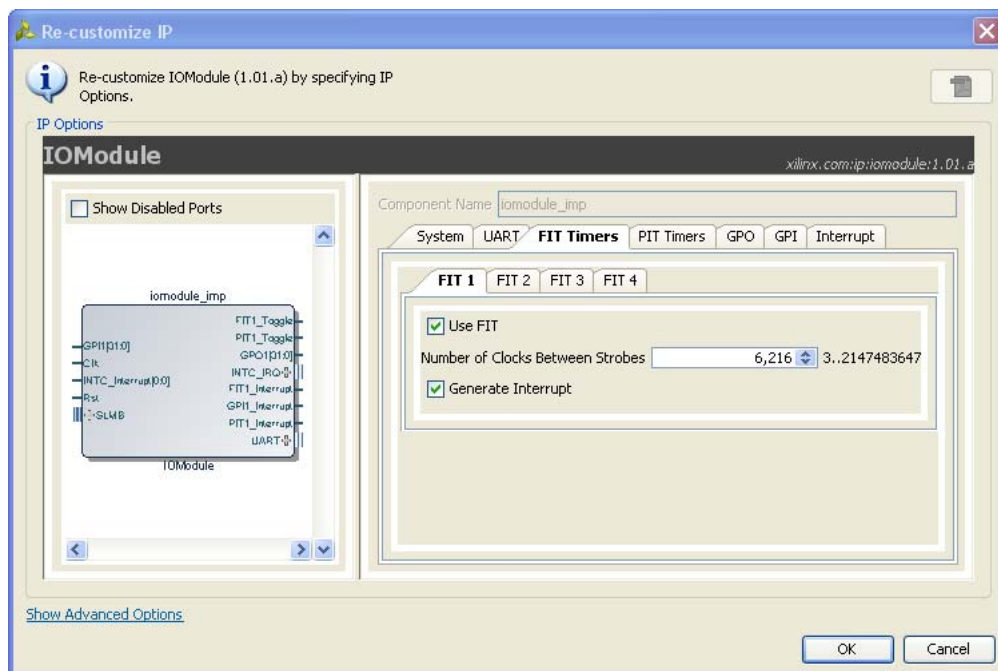

Figure 4-3: FIT Timers Parameter Tab

- **Use FIT** - Enable the Fixed Interval Timer.
- **Number of Clocks Between Strokes** - The number of clock cycles between each strobe.
- **Generate Interrupt** - Generate an interrupt for each Fixed Interval Timer strobe.

The PIT Timer parameter tab showing the parameters for one of the four timers is shown in Figure 4-4.

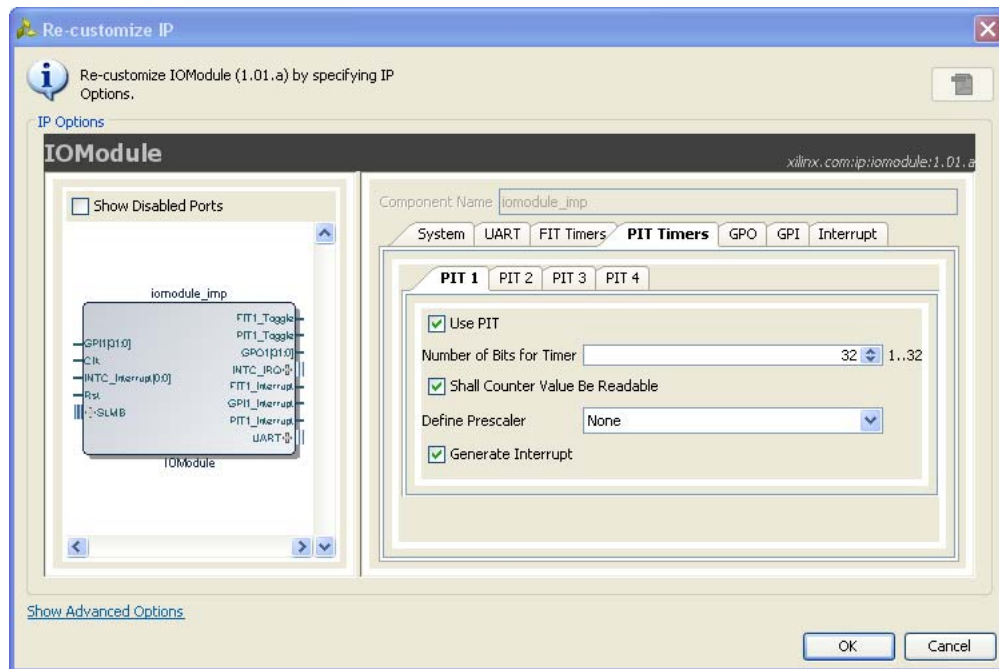

Figure 4-4: PIT Timers Parameter Tab

- **Use PIT** - Enable the Programmable Interval Timer.
- **Number of Bits for Timer** - The maximum number of cycles to count before stopping or restarting.
- **Shall Counter Value be Readable** - The Programmable Interval Timer counter is readable by software when this parameter is set. Unless resource usage is very critical it is recommended to keep this enabled.
- **Define Prescaler** - Selects a prescaler as source for the Programmable Interval Timer count. When no prescaler is selected the core input clock is used. Any Programmable Interval Timer or Fixed Interval Timer can be used as prescaler, as well as a dedicated external enable input.
- **Generate Interrupt** - Generate an interrupt when the Programmable Interval Timer has counted down to zero.

The GPO parameter tab showing the parameters for one of the four General Purpose Output ports is shown in Figure 4-5.

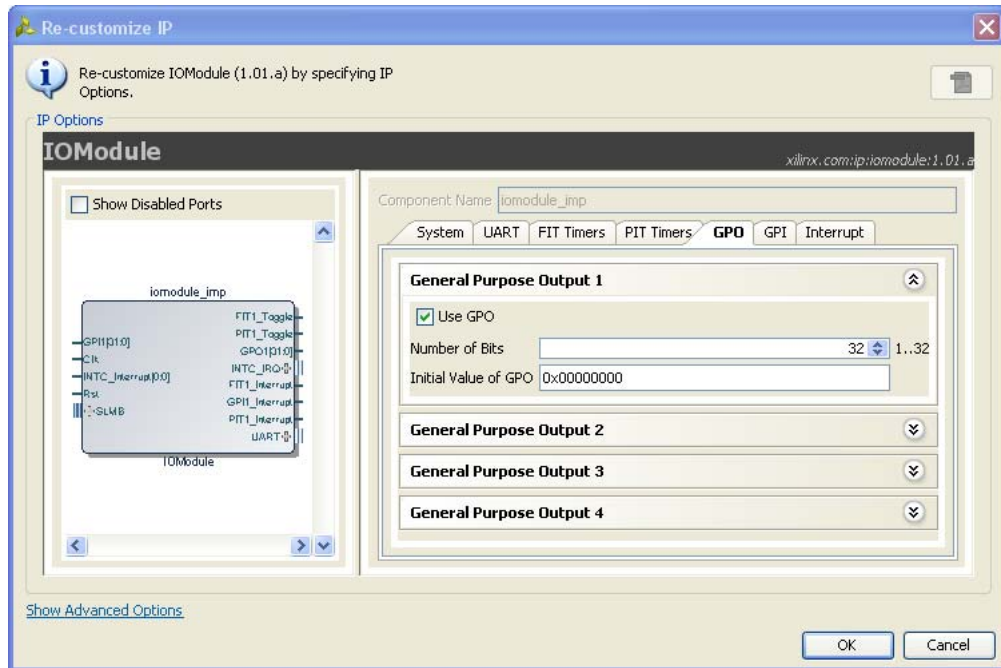

Figure 4-5: GPO Parameter Tab

- **Use GPO** - Enable the General Purpose Output port.
- **Number of Bits** - Set the number of bits of the General Purpose Output port.
- **Initial Value of GPO** - Set the initial value of the General Purpose Output port. The right most bit in the value is assigned to bit 0 of the port, the next right most to bit 1, and so on.

The GPI parameter tab showing the parameters for one of the four General Purpose Input ports is shown in [Figure 4-6](#).

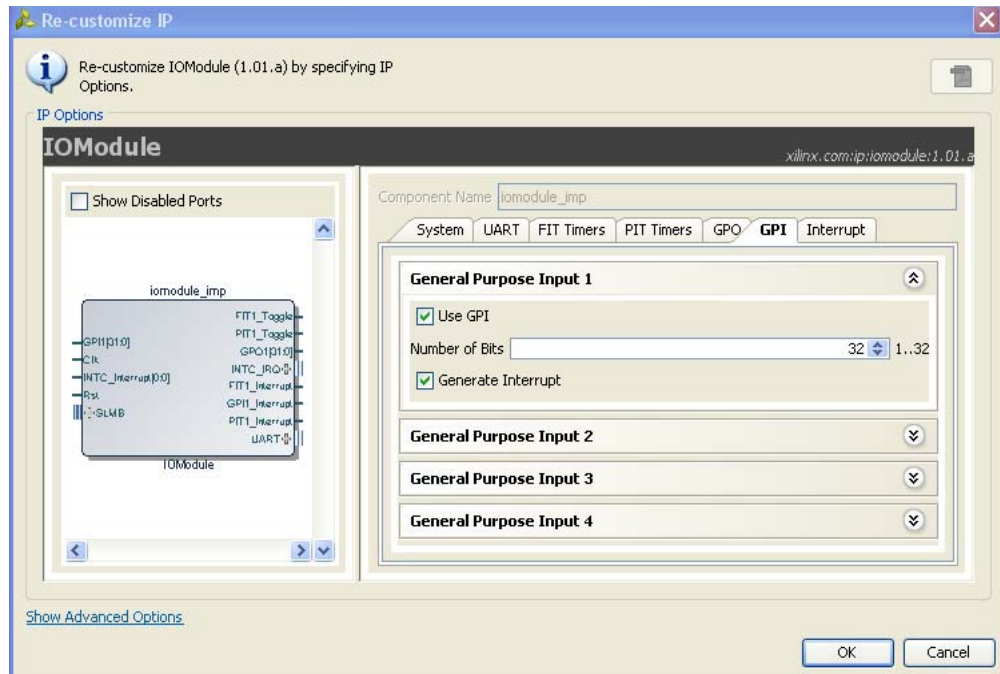

Figure 4-6: GPI Parameter Tab

- **Use GPI** - Enable the General Purpose Input port.
- **Number of Bits** - Set the number of bits of the General Purpose Input port.
- **Generate Interrupt** - Generate an interrupt when a General Purpose Input changes.

The Interrupt parameter tab is shown in [Figure 4-7](#).

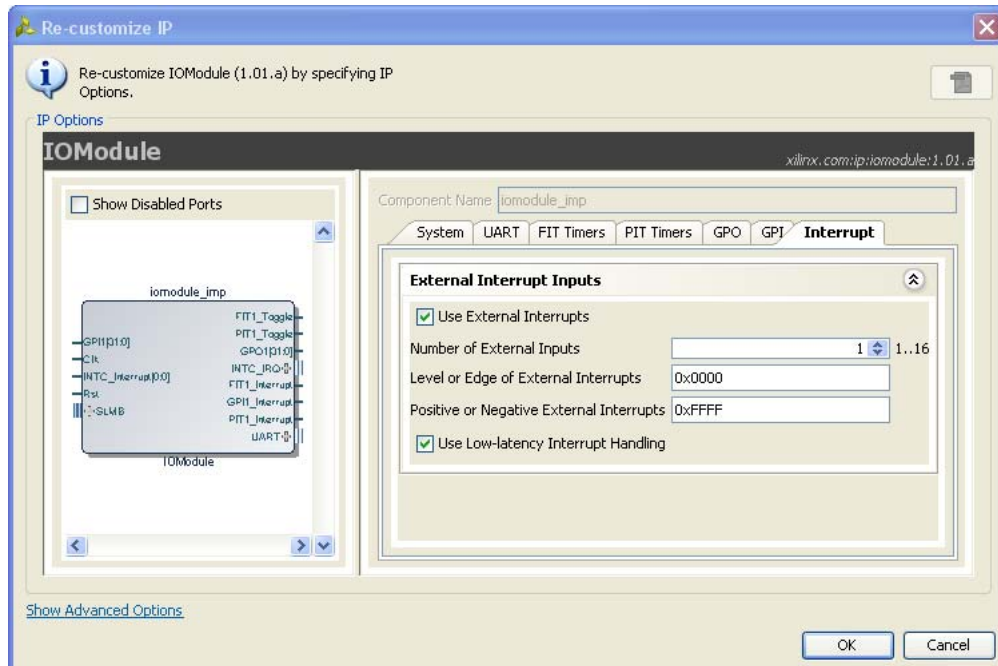

Figure 4-7: Interrupt Parameter Tab

- **Use External Interrupts** - Enable the use of external interrupt inputs.
- **Number of External Inputs** - Select the number of used external interrupt inputs.
- **Level or Edge of External Interrupts** - Select whether the input is considered level sensitive or edge triggered. Each bit in the value corresponds to the equivalent interrupt input. When a bit is set to one, the interrupt is edge triggered, otherwise it is level sensitive.
- **Positive or Negative External Interrupts** - Set whether to use high or low level for level sensitive interrupts, and rising or falling edge for edge triggered interrupts. Each bit in the value corresponds to the equivalent interrupt input. When a bit is set to one, high level or rising edge is used, otherwise low level or falling edge is used.
- **Use Low-latency Interrupt Handling** - Enable the use of low-latency interrupt handling.

Parameter Values

To obtain an I/O Module that is uniquely tailored a specific system, certain features can be parameterized in the I/O module design. This allows for configuring a design that only uses the resources required by the system, and operates with the best possible performance. The features that can be parameterized in I/O Module designs are shown in [Table 4-1](#).

Table 4-1: I/O Module Parameters

Parameter Name	Feature/Description	Allowable Values	Default Value	VHDL Type
C_FAMILY ⁽¹⁾	FPGA Architecture	Supported architectures	"virtex5"	string
I/O Bus Parameter				
C_USE_IO_BUS	Use I/O Bus	0 = Not Used 1 = Used	0	integer
UART Parameters				
C_USE_UART_RX	Use UART Receive	0 = Not Used 1 = Used	0	integer
C_USE_UART_TX	Use UART Transmit	0 = Not Used 1 = Used	0	integer
C_UART_BAUDRATE	Baud rate of the UART in bits per second	integer (e.g. 115200)	9600	integer
C_UART_PROG_BAUDRATE	Programmable UART Baud rate	0 = Not Used 1 = Used	0	integer
C_UART_DATA_BITS	The number of data bits in the serial frame	5 - 8	8	integer
C_UART_USE_PARITY	Determines whether parity is used or not	0 = No Parity 1 = Use Parity	0	integer
C_UART_ODD_PARITY	If parity is used, determines whether parity is odd or even	0 = Even Parity 1 = Odd Parity	0	integer
C_UART_RX_INTERRUPT	Use UART RX Interrupt in INTC	0 = Not Used 1 = Used	0	integer
C_UART_TX_INTERRUPT	Use UART TX Interrupt in INTC	0 = Not Used 1 = Used	0	integer
C_UART_ERROR_INTERRUPT	Use UART ERROR Interrupt in INTC	0 = Not Used 1 = Used	0	integer
FIT Parameters				
C_USE_FITx ⁽²⁾	Enable implementation of FIT	0 = Not Used 1 = Used	0	integer
C_FITx_No_CLOCKS ⁽²⁾	The number of clock cycles between stobes	>2	6216	integer
C_FITx_INTERRUPT ⁽²⁾	Use FITx_Interrupt in INTC	0 = Not Used 1 = Used	0	integer
PIT Parameters				
C_USE_PITx ⁽²⁾	Enable implementation of PIT	0 = Not Used 1 = Used	0	integer
C_PITx_SIZE ⁽²⁾	Size of PITx counter	1 - 32	1	integer
C_PITx_READABLE ⁽²⁾	Make PITx counter software readable	0 = Not SW readable 1 = SW readable	1	integer

Table 4-1: I/O Module Parameters (Cont'd)

Parameter Name	Feature/Description	Allowable Values	Default Value	VHDL Type
C_PITx_PRESCALER ⁽²⁾⁽³⁾	Select PITx prescaler	0 = No prescaler 1 = FIT1 2 = FIT2 3 = FIT3 4 = FIT4 5 = PIT1 6 = PIT2 7 = PIT3 8 = PIT4 9 = External	0	integer
C_PITx_INTERRUPT ⁽²⁾	Use PITx_Interrupt in INTC	0 = Not Used 1 = Used	0	integer
GPO Parameters				
C_USE_GPOx ⁽²⁾	Use GPOx	0 = Not Used 1 = Used	0	integer
C_GPOx_SIZE ⁽²⁾	Size of GPOx	1 - 32	32	integer
C_GPOx_INIT ⁽²⁾	Initial value for GPOx	Fit Range (31:0)	all zeros	std_logic_vector
GPI Parameters				
C_USE_GPIx ⁽²⁾	Use GPIx	0 = Not Used 1 = Used	0	integer
C_GPIx_SIZE ⁽²⁾	Size of GPIx	1 - 32	32	integer
INTC Parameters				
C_INTC_USE_EXT_INTR	Use I/O Module external interrupt inputs	0 = Not Used 1 = Used	0	integer
C_INTC_INTR_SIZE	Number of external interrupt inputs used	1 - 16	1	integer
C_INTC_LEVEL_EDGE	Level or edge triggered for each external interrupt	For each bit: 0 = Level 1 = Edge	level	std_logic_vector
C_INTC_POSITIVE	Polarity for each external interrupt	For each bit: 0 = active-Low 1 = active-High	active-High	std_logic_vector
C_INTC_HAS_FAST	Use fast interrupt mode	0 = Not Used 1 = Used	0	integer
C_INTC_ADDR_WIDTH	Interrupt Address width	5 - 32	32	integer
C_INTC_BASE_VECTORS	Relocatable base vector address	0x00000000 - 0xFFFFFFFF ⁽⁴⁾	0x00000000	std_logic_vector

1. Values automatically populated by tool.

2. x =1, 2, 3 or 4.

3. Selecting PIT prescaler the same as PITx is illegal, e.g. PIT2 cannot be prescaler to itself.

4. The 7 least significant bits must all be 0.

Constraining the Core

Required Constraints

There are no required constraints for this core.

Device, Package, and Speed Grade Selections

There are no Device, Package or Speed Grade requirements for this core.

Clock Frequencies

There are no specific clock frequency requirements for this core.

Clock Management

The I/O Module is fully synchronous with all clocked elements clocked by the C1k input.

To operate properly when connected to MicroBlaze™, the C1k must be the same as the MicroBlaze C1k.

Clock Placement

There are no specific Clock placement requirements for this core.

Banking

There are no specific Banking rules for this core.

Transceiver Placement

There are no Transceiver Placement requirements for this core.

I/O Standard and Placement

There are no specific I/O standards and placement requirements for this core.

SECTION III: ISE DESIGN SUITE

Customizing and Generating the Core

Constraining the Core

Customizing and Generating the Core

This chapter includes information on using Xilinx tools to customize and generate the core in the ISE® Design Suite.

GUI

The I/O Module parameters are divided in seven tabs: System, UART, FIT Timers, PIT Timers, GPO, GPI and Interrupt.

The System tab showing the Addresses parameters is shown in [Figure 6-1](#).

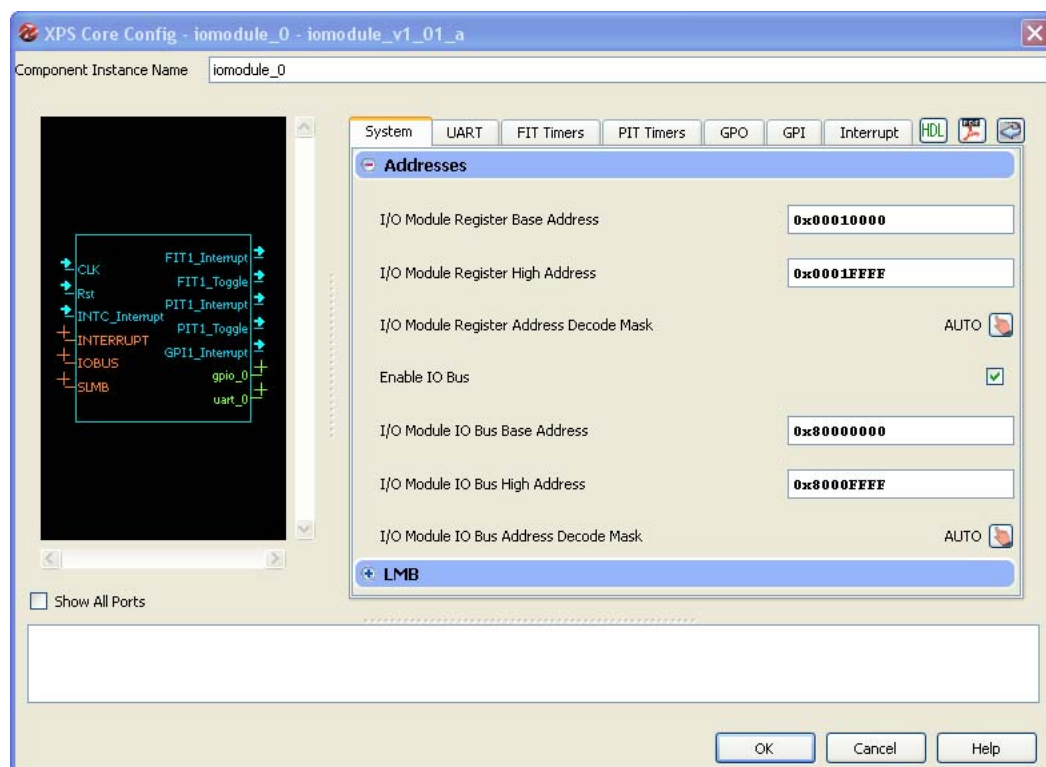

Figure 6-1: System Tab

- **I/O Module Register Base Address** - Base address of the internal registers.
- **I/O Module Register High Address** - High address of the internal registers.

- **I/O Module Register Address Decode Mask** - A mask indicating which address bits the module takes into account when decoding a register access.
- **Enable IO Bus** - Enables the I/O Bus to connect to DRP or external peripherals.
- **I/O Module IO Bus Base Address** - Base address of the I/O Bus.
- **I/O Module IO Bus High Address** - High address of the I/O Bus.
- **I/O Module IO Bus Address Decode Mask** - A mask indicating which address bits the module takes into account when decoding an I/O Bus access.

The UART parameter tab is shown in [Figure 6-2](#).

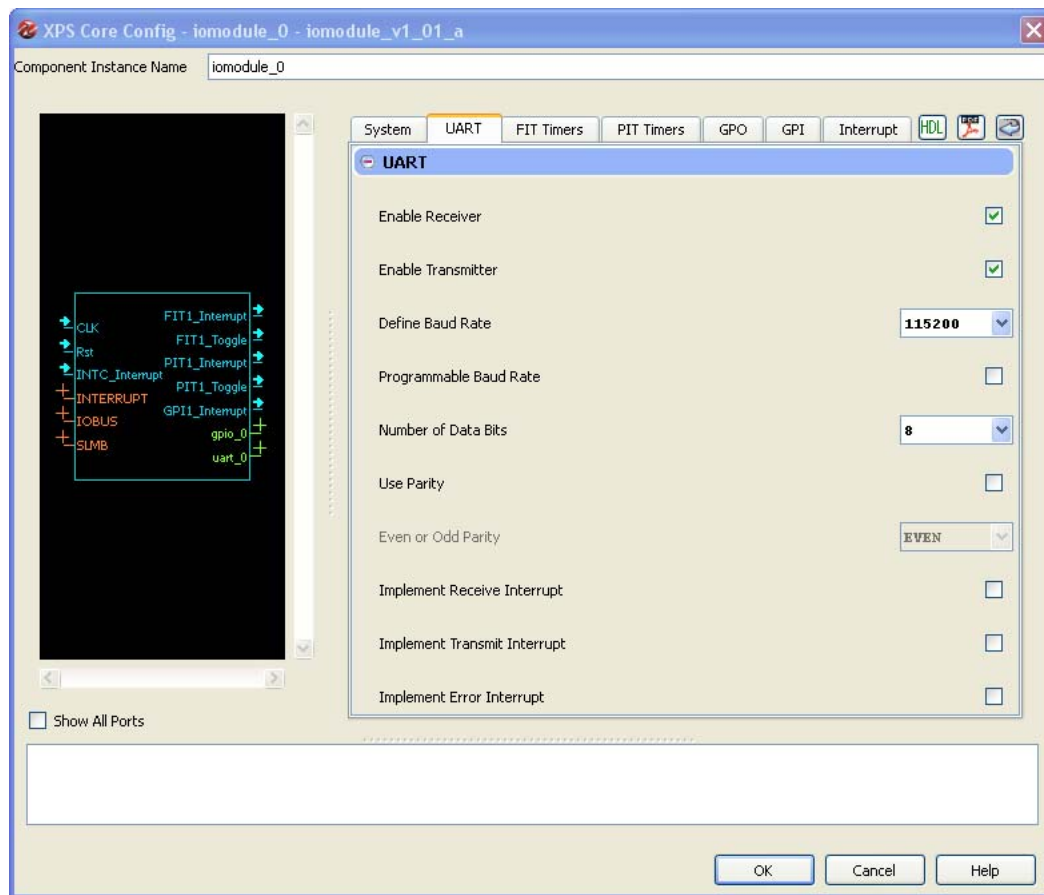

Figure 6-2: UART Parameter Tab

- **Enable Receiver** - Enables UART receiver for character input. This is automatically connected to standard input (`stdin`) in the software program.
- **Enable Transmitter** - Enables UART transmitter for character output. This is automatically connected to standard output (`stdout`) in the software program.
- **Define Baud Rate** - Sets the UART baud rate. To get the correct baud rate, the input clock frequency must also be correctly defined.

- **Programmable Baud Rate** - Determines if the UART baud rate is programmable. The default baud rate is calculated based on the input clock frequency and the defined baud rate.
- **Number of Data Bits** - Defines the number of data bits used by the UART. Should almost always be set to 8.
- **Use Parity** - Enable this parameter to use parity checking of the UART characters.
- **Even or Odd Parity** - Select odd or even parity. Only available when parity is used.
- **Implement Receive Interrupt** - Generate an interrupt when the UART has received a character. When the interrupt is not enabled the UART must be polled to check if data has been received.
- **Implement Transmit Interrupt** - Generate an interrupt when the UART has sent a character. When the interrupt is not enabled the UART must be polled to wait until data has been transmitted.
- **Implement Error Interrupt** - Generate an interrupt if an error occurs when the UART receives a character. This error can be a framing error, an overrun error or a parity error (if parity is used), When the interrupt is not enabled the UART must be polled to check if an error has occurred after a character has been received.

The FIT Timer parameter tab showing the parameters for one of the four timers is shown in Figure 6-3.

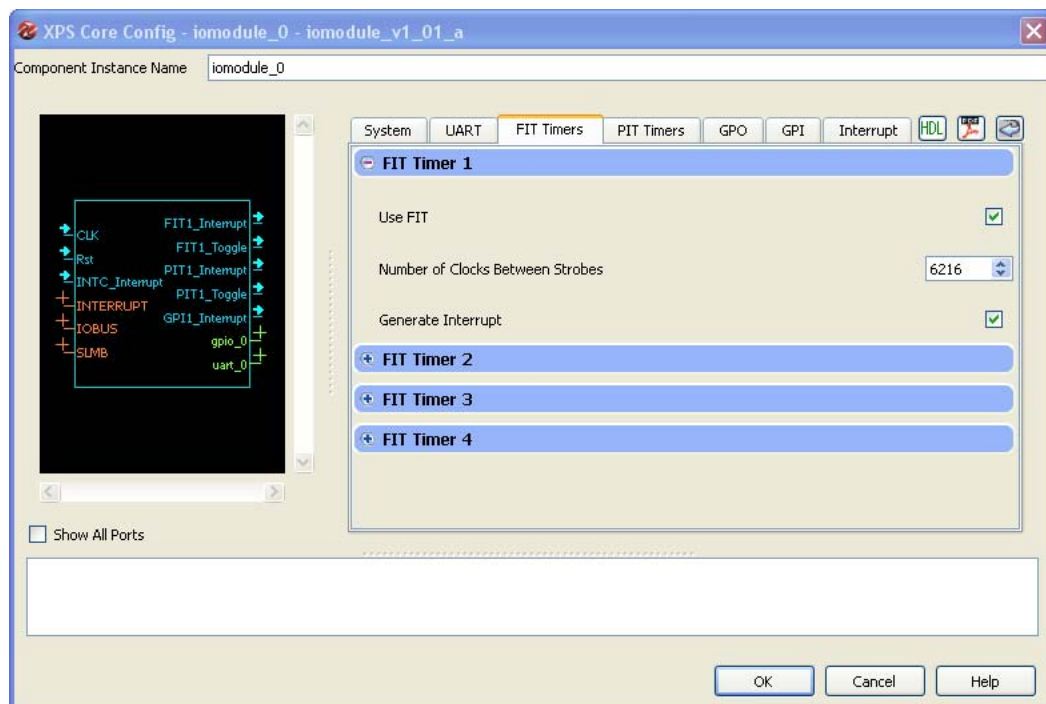

Figure 6-3: FIT Timers Parameter Tab

- Use FIT - Enable the Fixed Interval Timer.

- **Number of Clocks Between Strobes** - The number of clock cycles between each strobe.
- **Generate Interrupt** - Generate an interrupt for each Fixed Interval Timer strobe.

The PIT Timer parameter tab showing the parameters for one of the four timers is shown in Figure 6-4.

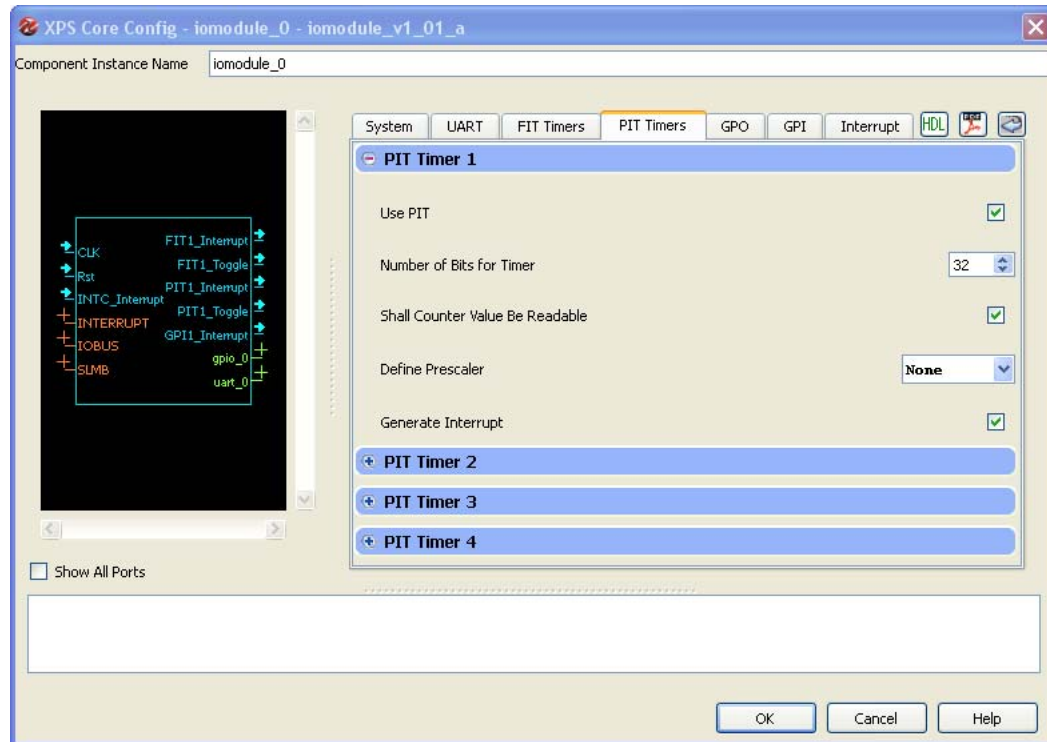

Figure 6-4: PIT Timers Parameter Tab

- **Use PIT** - Enable the Programmable Interval Timer.
- **Number of Bits for Timer** - The maximum number of cycles to count before stopping or restarting.
- **Shall Counter Value be Readable** - The Programmable Interval Timer counter is readable by software when this parameter is set. Unless resource usage is very critical it is recommended to keep this enabled.
- **Define Prescaler** - Selects a prescaler as source for the Programmable Interval Timer count. When no prescaler is selected the core input clock is used. Any Programmable Interval Timer or Fixed Interval Timer can be used as prescaler, as well as a dedicated external enable input.
- **Generate Interrupt** - Generate an interrupt when the Programmable Interval Timer has counted down to zero.

The GPO parameter tab showing the parameters for one of the four General Purpose Output ports is shown in Figure 6-5.

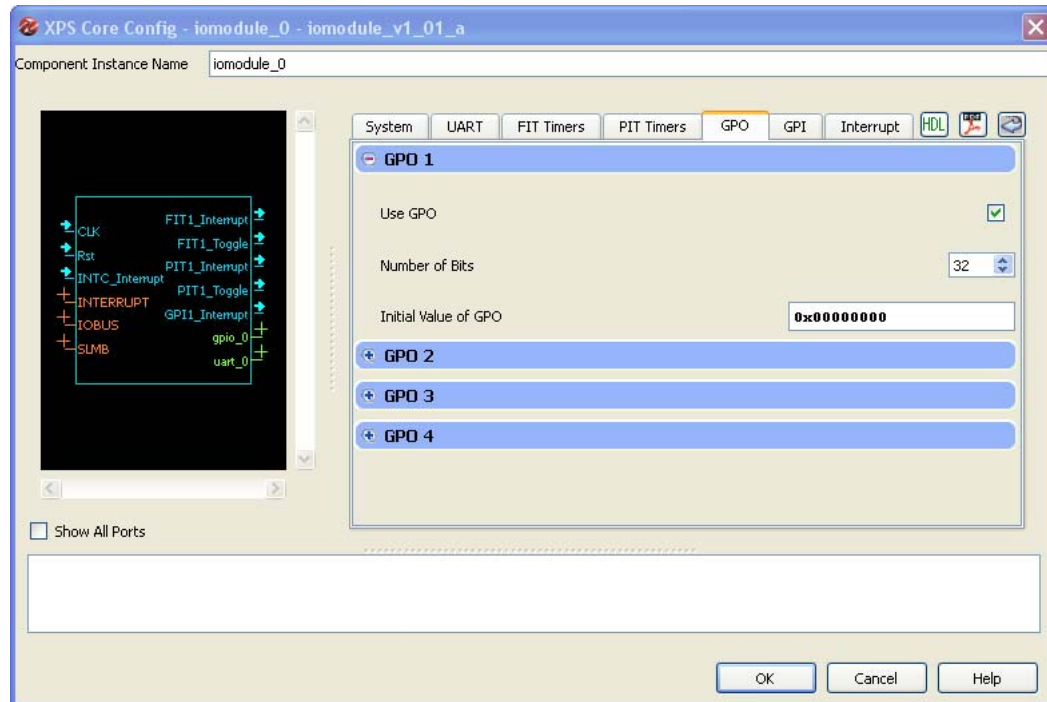

Figure 6-5: GPO Parameter Tab

- **Use GPO** - Enable the General Purpose Output port.
- **Number of Bits** - Set the number of bits of the General Purpose Output port.
- **Initial Value of GPO** - Set the initial value of the General Purpose Output port. The right most bit in the value is assigned to bit 0 of the port, the next right most to bit 1, and so on.

The GPI parameter tab showing the parameters for one of the four General Purpose Input ports is shown in [Figure 6-6](#).

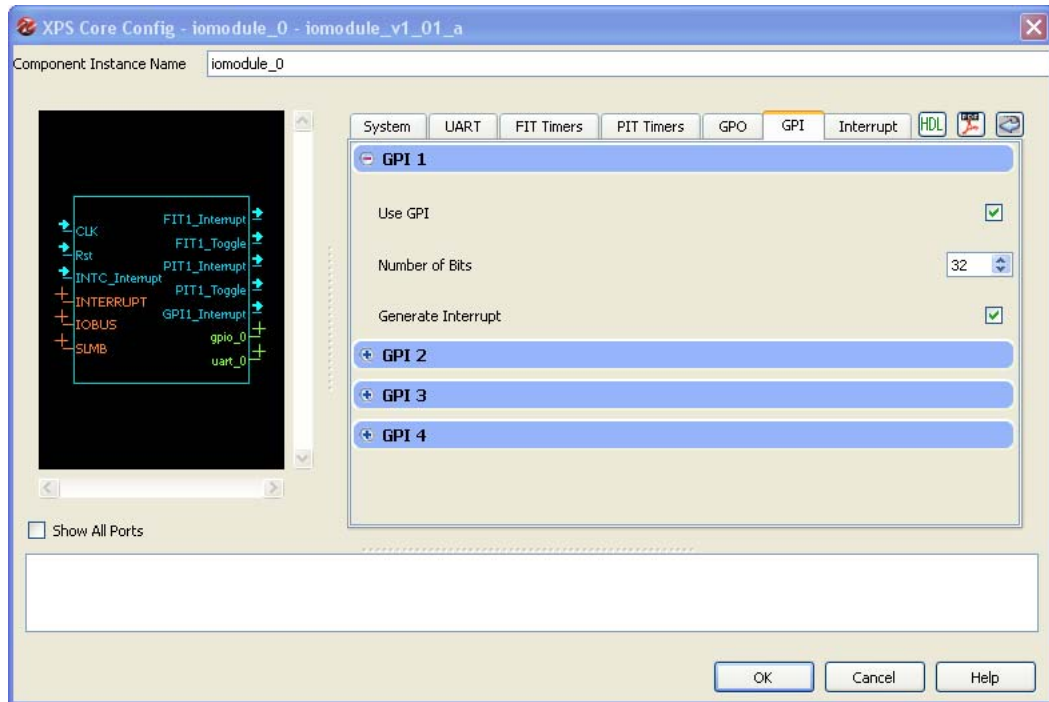

Figure 6-6: GPI Parameter Tab

- **Use GPI** - Enable the General Purpose Input port.
- **Number of Bits** - Set the number of bits of the General Purpose Input port.
- **Generate Interrupt** - Generate an interrupt when a General Purpose Input changes.

The Interrupt parameter tab is shown in Figure 6-7.

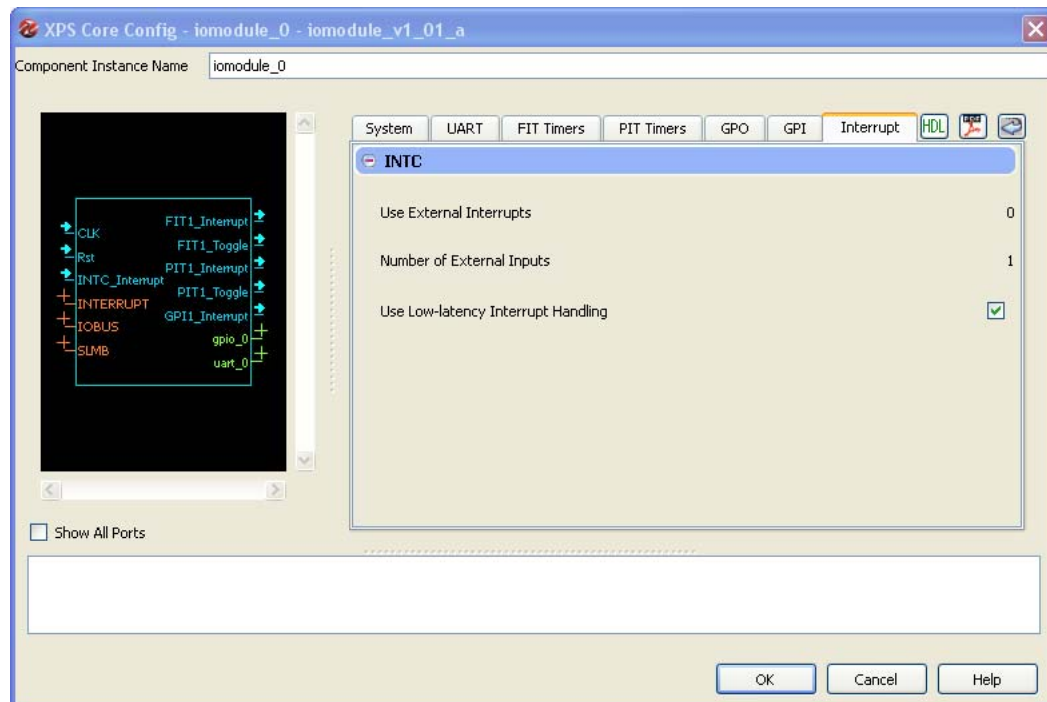

Figure 6-7: Interrupt Parameter Tab

- **Use External Interrupts** - Shows if external interrupt inputs are used.
- **Number of External Inputs** - Shows the number of used external interrupt inputs.
- **Use Low-latency Interrupt Handling** - Enable the use of low-latency interrupt handling.

Parameter Values

To allow the user to obtain an I/O Module that is uniquely tailored a specific system, certain features can be parameterized in the I/O module design. This allows the user to configure a design that only utilizes the resources required by the system, and operates with the best possible performance. The specific features that can be parameterized in Xilinx I/O Module EDK designs are shown in Table 6-1. See SECTION II: VIVADO DESIGN SUITE, Chapter 5 Customizing and Generating the Core for additional parameters.

Table 6-1: EDK I/O Module Parameters

Parameter Name	Feature/Description	Allowable Values	Default Value	VHDL Type
C_FREQ ⁽¹⁾	Frequency of CLK input		100000000	integer
C_INSTANCE ⁽¹⁾	Instance name	Any legal VHDL string	"iomodule"	string
C_BASEADDR	LMB I/O Module Register Base Address	Valid Address Range ⁽²⁾	0xFFFFFFFF	std_logic_vector
C_HIGHADDR	LMB I/O Module Register High Address	Valid Address Range ⁽²⁾	0x00000000	std_logic_vector
C_MASK	LMB I/O Module Register Address Space Decode Mask	Valid decode mask ⁽³⁾	0x00800000	std_logic_vector
C_IO_HIGHADDR	LMB I/O Module I/O Bus Base Address	Valid Address Range ⁽²⁾	0xFFFFFFFF	std_logic_vector
C_IO_LOWADDR	LMB I/O Module I/O Bus Address	Valid Address Range ⁽²⁾	0x00000000	std_logic_vector
C_IO_MASK	LMB I/O Module I/O Bus Address Space Decode Mask	Valid decode mask ⁽³⁾	0x00800000	std_logic_vector
C_LMB_AWIDTH	LMB Address Bus Width	32	32	integer
C_LMB_DWIDTH	LMB Data Bus Width	32	32	integer

1. Values automatically populated by tool.

2. The range specified by BASEADDR and HIGHADDR must comprise a complete, contiguous power-of-two range, such that range = 2ⁿ, and the n least significant bits of BASEADDR must be zero.

3. The decode mask determines which bits are used by the LMB decode logic to decode a valid access to LMB.

Constraining the Core

Clock Management

The I/O Module is fully synchronous with all clocked elements clocked by the C1k input.

To operate properly when connected to MicroBlaze™, the C1k must be the same as the MicroBlaze C1k.

SECTION IV: APPENDICES

Migrating

Debugging

Application Software Development

Additional Resources

Migrating

This appendix describes migrating from older versions of the IP to the current IP release.

For information on migrating to the Vivado™ Design Suite, see the *Vivado Design Suite Migration Methodology Guide* [\[Ref 3\]](#).

Debugging

Solution Centers

See the [Xilinx Solution Centers](#) for support on devices, software tools, and intellectual property at all stages of the design cycle. Topics include design assistance, advisories, and troubleshooting tips.

Application Software Development

Device Drivers

The I/O Module is supported by the IO Module driver, included with Xilinx Software Development Kit.

Additional Resources

Xilinx Resources

For support resources such as Answers, Documentation, Downloads, and Forums, see the Xilinx Support website at:

www.xilinx.com/support.

For a glossary of technical terms used in Xilinx documentation, see:

www.xilinx.com/company/terms.htm.

References

These documents provide supplemental material useful with this user guide:

1. MicroBlaze Processor Reference Guide ([UG081](#))
 2. 7 Series FPGAs Configuration User Guide ([UG470](#))
 3. Vivado™ Design Suite Migration Methodology Guide ([UG911](#))
-

Technical Support

Xilinx provides technical support at www.xilinx.com/support for this LogiCORE™ IP product when used as described in the product documentation. Xilinx cannot guarantee timing, functionality, or support of product if implemented in devices that are not defined in the documentation, if customized beyond that allowed in the product documentation, or if changes are made to any section of the design labeled DO NOT MODIFY.

See the IDS Embedded Edition Derivative Device Support web page (www.xilinx.com/ise/embedded/ddsupport.htm) for a complete list of supported derivative devices for this core.

Revision History

The following table shows the revision history for this document.

Date	Version	Revision
07/25/12	1.0	Initial Xilinx release. This Product Guide is derived from DS866.
10/16/12	1.1	Updated with description of support for MicroBlaze relocatable base vectors through the parameter C_INTC_BASE_VECTORS.

Notice of Disclaimer

The information disclosed to you hereunder (the "Materials") is provided solely for the selection and use of Xilinx products. To the maximum extent permitted by applicable law: (1) Materials are made available "AS IS" and with all faults, Xilinx hereby DISCLAIMS ALL WARRANTIES AND CONDITIONS, EXPRESS, IMPLIED, OR STATUTORY, INCLUDING BUT NOT LIMITED TO WARRANTIES OF MERCHANTABILITY, NON-INFRINGEMENT, OR FITNESS FOR ANY PARTICULAR PURPOSE; and (2) Xilinx shall not be liable (whether in contract or tort, including negligence, or under any other theory of liability) for any loss or damage of any kind or nature related to, arising under, or in connection with, the Materials (including your use of the Materials), including for any direct, indirect, special, incidental, or consequential loss or damage (including loss of data, profits, goodwill, or any type of loss or damage suffered as a result of any action brought by a third party) even if such damage or loss was reasonably foreseeable or Xilinx had been advised of the possibility of the same. Xilinx assumes no obligation to correct any errors contained in the Materials or to notify you of updates to the Materials or to product specifications. You may not reproduce, modify, distribute, or publicly display the Materials without prior written consent. Certain products are subject to the terms and conditions of the Limited Warranties which can be viewed at <http://www.xilinx.com/warranty.htm>; IP cores may be subject to warranty and support terms contained in a license issued to you by Xilinx. Xilinx products are not designed or intended to be fail-safe or for use in any application requiring fail-safe performance; you assume sole risk and liability for use of Xilinx products in Critical Applications: <http://www.xilinx.com/warranty.htm#critapps>.

© Copyright 2012 Xilinx, Inc. Xilinx, the Xilinx logo, Artix, ISE, Kintex, Spartan, Virtex, Vivado, Zynq, and other designated brands included herein are trademarks of Xilinx in the United States and other countries. All other trademarks are the property of their respective owners.